



GENERATION FUTURE

DUST MANAGER



USER INSTRUCTIONS

IMPORTANT SAFETY REMINDERS

User's manual - This cleaner should only be used for its intended purpose as described in these instructions. Ensure that these are fully understood before operating this appliance.

Only use attachments recommended or supplied by Hoover.

When using cleaning tools ensure that the cleaner is kept in the upright (parked) position. This will avoid possible damage to the carpet or floor covering. When cleaning stairs **DO NOT** position the cleaner above you.

Safety with Children, Elderly or the Infirm: Do not let children play with the appliance or its controls. Please supervise the use of the appliance by older children, the elderly and the infirm.

STATIC ELECTRICITY. Some carpets can cause a small build up of static electricity. Any static discharge is not hazardous to health.

DO NOT use your cleaner out of doors or on any wet surface or for wet pick up.

Keep hands, feet, loose clothing and hair away from rotating brushes.

DO NOT pick up hard or sharp objects, matches, cigarette ends or other similar items.

DO NOT pick up flammable liquids such as cleaning fluids, petrol etc. or their vapours.

Aerosol sprays may be flammable. **DO NOT** spray near cleaner.

SUPPLY CORD. **DO NOT** run over the supply cord when using your cleaner or remove the plug by pulling on the supply cord.

FAULTS. **DO NOT** continue to use your cleaner if it appears to be faulty. If the supply cord is damaged stop using the cleaner IMMEDIATELY. The supply cord must be replaced by an authorised Hoover service engineer to avoid a safety hazard.

AFTER USE. Switch the cleaner off and remove the plug from the electricity supply. Always switch off and remove the plug before cleaning the appliance or attempting any maintenance task.

HOOVER SERVICE. To ensure the continued safe and efficient operation of this appliance we recommend that any servicing or repairs are only carried out by an authorised Hoover service engineer

Genuine Hoover Spares and Consumables

Always replace parts with Genuine Hoover spares and consumables.

HOOVER SERVICE 08705 400 600
HOOVER SPARES 01204 556 111

Congratulations on the purchase of your new Hoover Dust Manager.

This highly advanced machine makes cleaning easier and more efficient.

You'll find it kinder to your carpets - and to you!

Please take the time to read this manual carefully.

You'll be ready to make the most of the special features only the new Hoover Dust Manager can offer!

WARNING! ELECTRICITY CAN BE EXTREMELY DANGEROUS

This appliance is double insulated and must not be earthed.

The plug is fitted with a 13 amp fuse.

IMPORTANT: The wires in the mains lead are coloured in accordance with the following code:

Blue - NEUTRAL

Brown - LIVE

HOOVER®
DUST MANAGER

GETTING TO KNOW YOUR CLEANER*

Effortless cleaning with your new Hoover DUST MANAGER

When first unpacking
your cleaner please
check all items
are included:

- Cleaner Body
- Handle with securing screw
- Crevice tool
- Dusting Brush
- Grooming Nozzle
- Pet Hair and Allergen Remover*

If any parts are missing
contact your retailer or
call the Hoover helpline
on 08705 400 600

DUST MANAGER

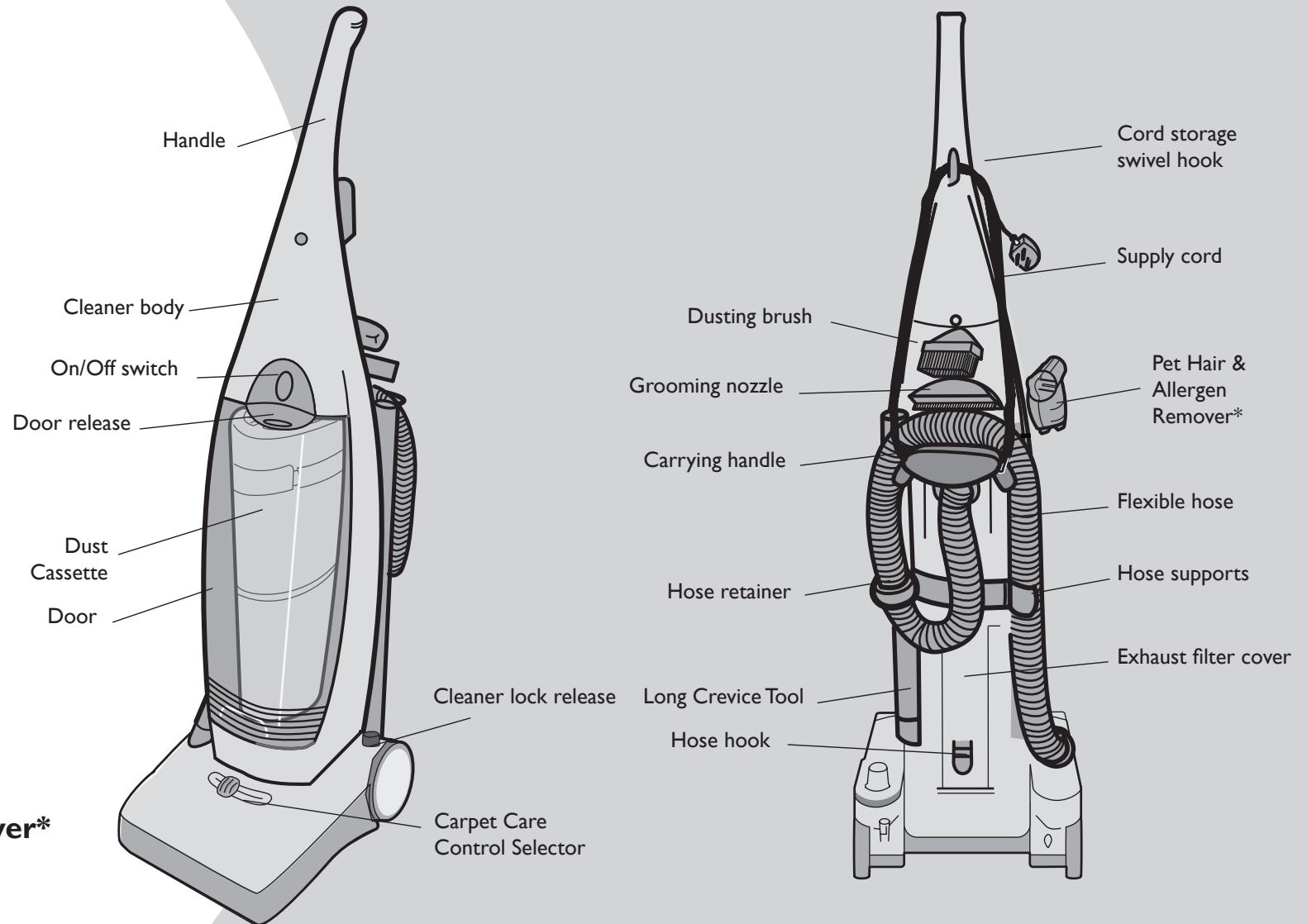

* Features may vary according to model

PREPARING TO USE YOUR CLEANER

Insert handle into body of cleaner. Slide into position. Ensure handle is flush with body of cleaner. Tighten large screw (pre-fitted to handle upper hole). Insert small screw into handle lower hole and tighten.

Check that the dust container is fitted.

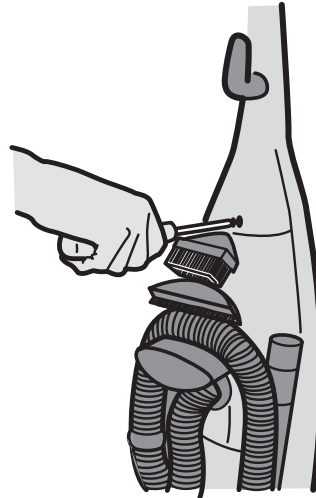

POWER SWITCH SETTING

Switching on and off

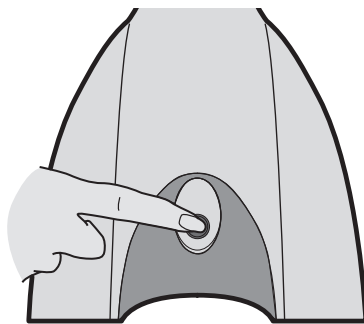

Push bottom of the On/Off switch to switch on. Push top of the On/Off switch to switch off.

CARPET CARE CONTROL SELECTOR

The carpet care control selector raises or lowers the height of the nozzle. The nozzle height will not change until the handle is released. Try various settings until you get the best results for each of your carpets.

IMPORTANT: When cleaning hard floors such as vinyl or linoleum, move the "Carpet Care Control Selector" to the Hard floor position. Failure to do so may cause damage to the floor surface.

Ensure that the cleaner is in an upright (parked) position.

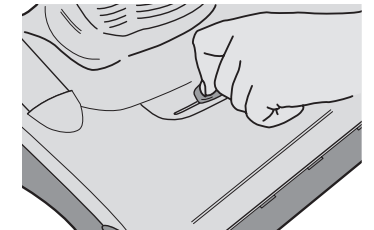

Slide selector to the position best suited to depth of carpet pile.

Using this cleaner for carpets with pile greater than 30mm is not recommended.

CLEANER LOCK RELEASE

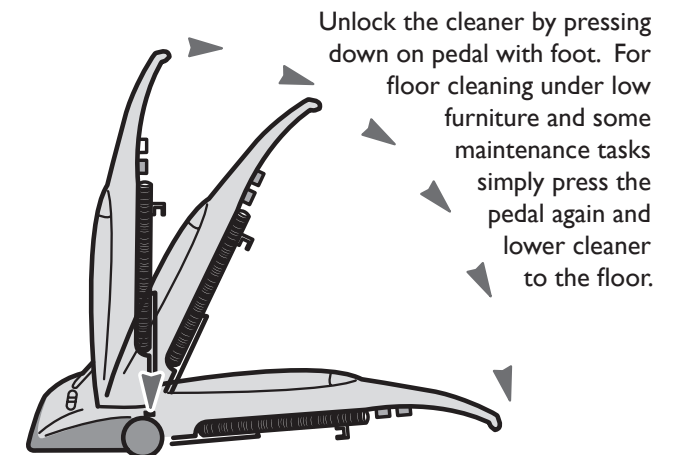

Unlock the cleaner by pressing down on pedal with foot. For floor cleaning under low furniture and some maintenance tasks simply press the pedal again and lower cleaner to the floor.

CLEANING TOOLS*

! IMPORTANT: When using cleaning tools, the cleaner must be kept in the upright (parked) position, particularly when cleaning stairs. The carpet height selector should also be set to tool mode:

Pet Hair & Allergen Remover*. (Certain models only)
Ideal for removing pet hairs.
Do not touch the rotating brush.



The long crevice tool provides extra reach and can be attached to both the dusting brush and the grooming nozzle.

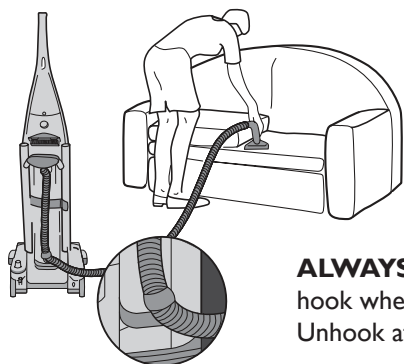
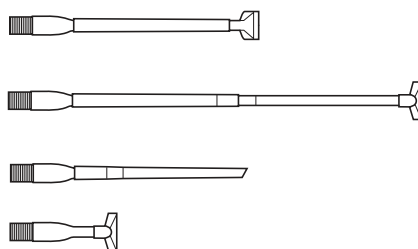

ALWAYS attach hose retainer to hook when using cleaning tools. Unhook after use.

CLEANING THE STAIRS

It is dangerous to place the cleaner above you whilst cleaning the stairs.

ALWAYS work with the cleaner below you. Ensure it is positioned up against the bottom step.

DO NOT attach hose retainer when cleaning the stairs.

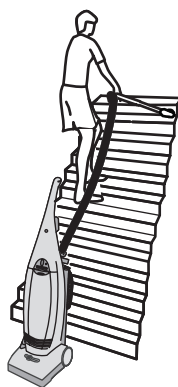

* Features vary according to model

EMPTYING THE DUST CASSETTE

IMPORTANT: DO NOT FILL ABOVE THE INDICATED MAX LEVEL MARK SHOWN ON THE CASSETTE .

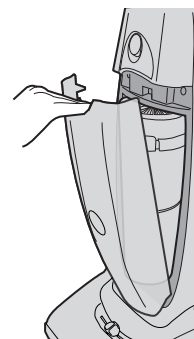

Press down on door release pad and remove door.



Remove the dust cassette from the cleaner using the handle grip on the front.



Rotate the BLUE filter pack to the unlock position to release from the dust cassette.

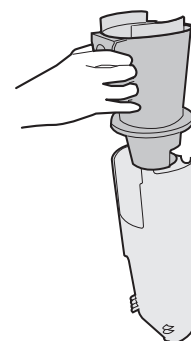

Turn the dust container and remove the BLUE transparent shroud including the RED vortex finder.



Empty the dust container of dirt and debris.

Repeat all steps in reverse to refit the dust container on the product. Make sure that the RED and BLUE components are refitted.

! IMPORTANT: For optimum cleaning performance, always keep your filters clean. Hoover recommends to wash Dust Manager cassette filters after 5 container empties.

CLEANING THE FILTERS*

Washing filter and foam:



Rotate the BLUE filter pack until the unlock position to release it from the dust container.

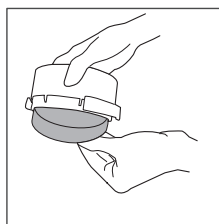

Separate the GREY foam filter from the BLUE filter pack using the tab provided.



Wash the GREY foam filter thoroughly.

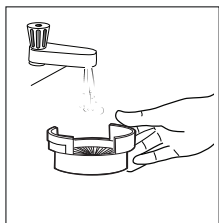

Gently tap to release excess dust. Wash the filter with the BLUE housing from the inside. **DO NOT USE HOT WATER OR DETERGENTS!**

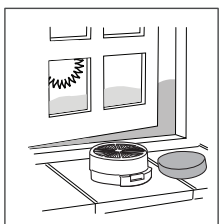

Remove excess water by shaking and leave to dry for 24 hours. Refit filters only when completely dry.

Do not use a brush as this will damage the filter.

* Features vary according to model

Washing pre-motor and exhaust filter:

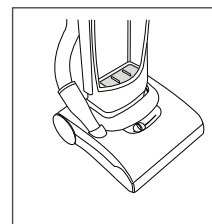

The pre-motor filter should be washed every three months.

The Carbon filter is normally maintenance free, this component should not be washed. If a replacement is required please contact our spares department.

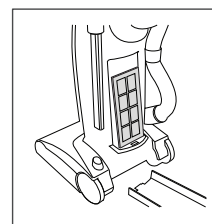

The exhaust filter should be washed every month. Press down on the latch to remove the exhaust cover and filter.

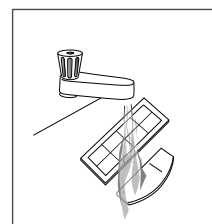

Wash filters under hand warm water. **DO NOT USE HOT WATER OR DETERGENTS!**

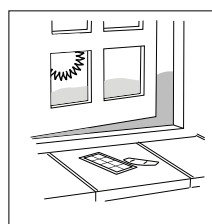

Remove excess water by shaking and leave to dry for 24 hours. Refit filters only when completely dry.



IMPORTANT: For optimum cleaning performance, always keep your filters clean.

CHANGING BELT OR BRUSHES



IMPORTANT: Switch cleaner off and remove plug from electricity supply before checking the brushes or removing hood.

If your cleaner is not picking up efficiently, the belt or brushes (or both) may need replacing, but first make sure you have:

- Emptied the dust container
- Cleaned filters
- Checked for blockages

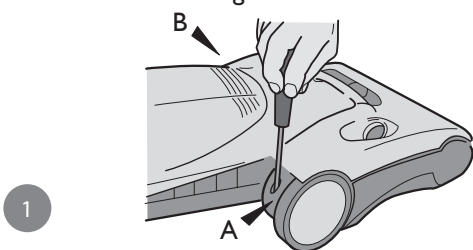

1 Remove hood

- Prise off the carpet care control selector
- Remove hood screws A and B.
- Lift off hood

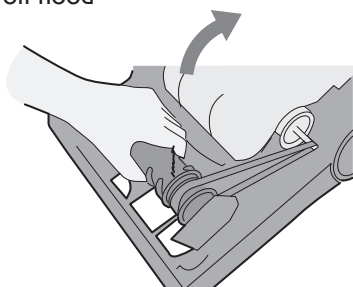

2 Remove brush assembly

- Inspect belt for signs of wear.
- To remove, pull brush cleaner assembly upwards out of cleaner housing. Remove belt from motor spindle then from brush assembly.

Replace belt

- Loop the new belt around the motor spindle then around the brush channel.

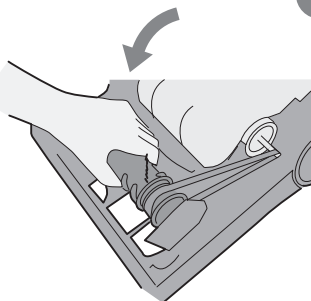

3

3 Refit brush assembly

- Hold the brush assembly and stretch the belt until brush mountings slot down into the cleaner housing. Rotate the brush to ensure free movement of the belt.

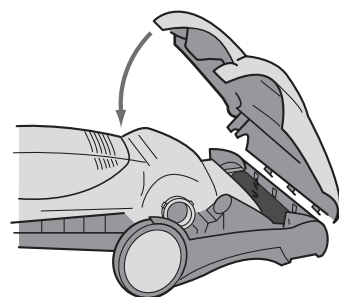

4

4 Refit hood

- Refit hood, ensuring the lugs along the front of hood are located in the slots along the front edge of baseplate.
- Secure hood, using screws A and B.

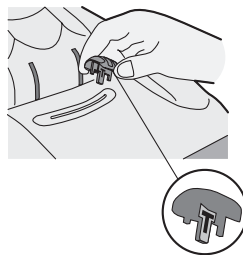

5

5 Refit carpet care control selector

- Ensure the raised face (T) is towards the front of the cleaner.

Removing a blockage from the Pet Hair & Allergen Remover* (Certain models only)

Open clip and lift cover to remove blockage.

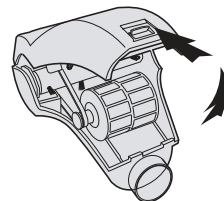

CLEARING A BLOCKAGE



IMPORTANT: Switch the cleaner off and remove the plug from the electricity supply before dismantling cleaner.

This cleaner is unlikely to become blocked, except by over filling of the dust container or accidentally picking up large solid objects. Clearing a blockage is simple.

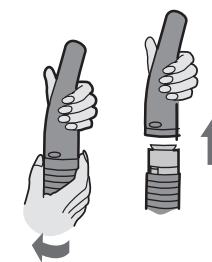

If cleaning tools were in use, check cleaning tool and extension tube first. Next check hose handgrip; to remove grip ribbed ring as shown, turn in direction of arrow and ease apart.



To check the hose, stretch it to full length and switch on the cleaner; the suction will dislodge most obstructions. If this is unsuccessful, switch off and unplug the cleaner. Remove the hose by turning it anti-clockwise as shown. Detach cassette and remove blockage.

For blockages in cleaner base:

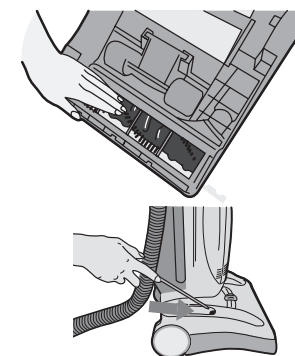

1. Turn the cleaner over and check that the brushes are free to rotate.

2. Check for a blockage in hose socket. Use a piece of wire or a blunt flexible rod to remove any obstructions.

* Features vary according to model

Genuine HOOVER spares
Tel. 01204 556 111

Always replace parts with genuine Hoover spares. These are available from your local Hoover dealer or direct from Hoover. When ordering parts always quote your model number.

Hoover service Tel. 08705 400 600

Should you require service at any time please call the HOOVER Service Office. Hoover have a computerised nationwide service network with over 500 engineers who will respond quickly to your call and guarantee your repair for 12 months.

Hoovercare

To maintain your HOOVER product in peak condition you may also wish to take out a Hoovercare policy, for which an annual payment provides a comprehensive maintenance and repair scheme. For further information telephone the HOOVER Service Office.

GUARANTEE STATEMENT

The guarantee conditions for the appliance are as defined by our representative in the country in which it is sold. Details regarding these conditions can be obtained from the dealer from whom the appliance was purchased, the bill of sale or receipt must be produced when making any claim under this guarantee.
 Subject to change without notice.

CONSUMABLES	CODE
CYCLONIC CASSETTE FILTER KIT: HEPA PREMOTOR FILTER AND FOAM	U44 - 35600746
PRE MOTOR FILTER	S77 - 03875160
AGITATOR	Y14 - 04845056
BELT	V17 - 09161985
HOSE	D1 - 04345084
MINI TURBO NOZZLE WITH INTEGRATED CREVICE TOOL	J28 - 35600703
MINI TURBO NOZZLE	J20 - 09200356

Use only HOOVER spares

Quality, Safety & Environment

As the owner of a new Hoover product we would like to tell you more about the high standards we have set on Quality, Safety and the Environment.

Quality

BSI ISO 9001

Hoovers factories have been independantly assessed for quality. Our products are made using a quality system which meets the requirements of ISO 9001.

Safety

Although safety certification of electrical applications is not required by law in the UK, Hoover believe that independant approval is the best way of demonstrating safety in design and manufacture.

The British Electrotechnical approvals Board (BEAB), the independant UK national authority for the safety of domestic electical appliances, ensure that European Safety Standards are met and are maintained throughout the production life of an appliance.

All appliances which pass these tests are permitted to carry this BEAB mark of safety:

**BEAB
Approved**

Environment - Weee Directive



This appliance is marked according to the European directive 2002/96/EC on Waste Electrical and Electronic Equipment (WEEE).

By ensuring this product is disposed of correctly, you will help prevent potential negative consequences for the environment and human health, which could otherwise be caused by inappropriate waste handling of this product.

The symbol on the product indicates that this product may not be treated as household waste. Instead it shall be handed over to the applicable collection point for the recycling of electrical and electronic equipment.

Disposal must be carried out in accordance with local environmental regulations for waste disposal.

For more detailed information about treatment, recovery and recycling of this product, please contact your local city office, your household waste disposal service or the shop where you purchased the product.

User checklist

If your cleaner is not working properly run through the following checklist.

1. Is there a working electricity supply to the cleaner?
Check with another electrical product.
2. Is the dust container full or choked with fine dust?
To empty the dust container see the instructions on page 5.
3. Is the hose blocked?
To clear a blockage, see the instructions on page 7.
4. Is there a blockage in the cleaner base?
To clear a blockage, see the instructions on page 7.
5. Are the filters blocked?
To clear the filters, see the instructions on page 6.
6. Is the nozzle height set correctly?
To set the carpet care control selector, see the instructions on page 4.
7. Are the brushes rotating correctly?
To check the brushes, see the instructions on page 7.
8. Has the cleaner overheated? If so, it will take about 30 minutes to reset itself.

If there is any doubt call the Hoover Service Office for advice. They may be able to assist you over the telephone.

A service charge will be made if the cleaner is examined and found to be in working order, has not been assembled in accordance with these instructions or has been used incorrectly.

WARNING!

A thermal cut out switches off the cleaner to prevent overheating if it is used when full or there is a blockage or dirty filters. If this should happen switch off, unplug and correct the fault. It will take about 30 minutes for the cut out to automatically reset.

IMPORTANT: Do not run cleaner over the supply cord as this could damage the supply cord insulation.



GENERATION FUTURE

Hoover Limited
Pentrebach
Merthyr Tydfil
Mid Glamorgan
CF48 4TU

© 2007
® Registered Trade Mark

* Features vary according to model



GENERATION FUTURE



Printed in P.R.C
0565 5287