



GENERATION FUTURE

DUST MANAGER



USER INSTRUCTIONS

IMPORTANT SAFETY REMINDERS

User's manual- This cleaner should only be used for its intended purpose as described in these instructions. Ensure that these are fully understood before operating this appliance.

Only use attachments recommended or supplied by Hoover.

When using cleaning tools ensure that the cleaner is kept in the upright (parked) position. This will avoid possible damage to the carpet or floor covering. When cleaning stairs **DO NOT** position the cleaner above you.

STATIC ELECTRICITY. Some carpets can cause a small build up of static electricity. Any static discharge is not hazardous to health.

DO NOT use your cleaner out of doors or on any wet surface or for wet pick up.

Keep hands, feet, loose clothing and hair away from rotating brushes.

DO NOT pick up hard or sharp objects, matches, cigarette ends or other similar items.

DO NOT pick up flammable liquids such as cleaning fluids, petrol etc. or their vapours.

Aerosol sprays may be flammable. **DO NOT** spray near cleaner.

SUPPLY CORD. **DO NOT** run over the supply cord when using your cleaner or remove the plug by pulling on the supply cord.

FAULTS. **DO NOT** continue to use your cleaner if it appears to be faulty. If the supply cord is damaged stop using the cleaner **IMMEDIATELY.** The supply cord must be replaced by an authorised Hoover service engineer to avoid a safety hazard.

AFTER USE. Switch the cleaner off and remove the plug from the electricity supply. Always switch off and remove the plug before cleaning the appliance or attempting any maintenance task.

HOOVER SERVICE. To ensure the continued safe and efficient operation of this appliance we recommend that any servicing or repairs are only carried out by an authorised Hoover service engineer.

**HOOVER SERVICE
HOOVER SPARES**

**08705 400 600
01204 556 111**

Use only HOOVER spares

Congratulations on the purchase of your new Hoover Dust Manager.

This highly advanced machine - with new technology unique to Hoover - makes cleaning easier and more efficient.

You'll find it kinder to your carpets - and to you!

Please take the time to read this manual carefully.

You'll be ready to make the most of the special features only the new Hoover Dust Manager can offer!

WARNING! ELECTRICITY CAN BE EXTREMELY DANGEROUS

This appliance is double insulated and must not be earthed.

The plug is fitted with a 13 amp fuse.

IMPORTANT: The wires in the mains lead are coloured in accordance with the following code:

Blue - NEUTRAL

Brown - LIVE

HOOVER®

DUST MANAGER

GETTING TO KNOW YOUR CLEANER*

**Effortless
cleaning
with your
new Hoover
DUST MANAGER...**

**When first unpacking
your cleaner please
check all items are
included.**

**If any parts are missing,
contact your retailer or
call the Hoover helpline
on 08705 400 600**

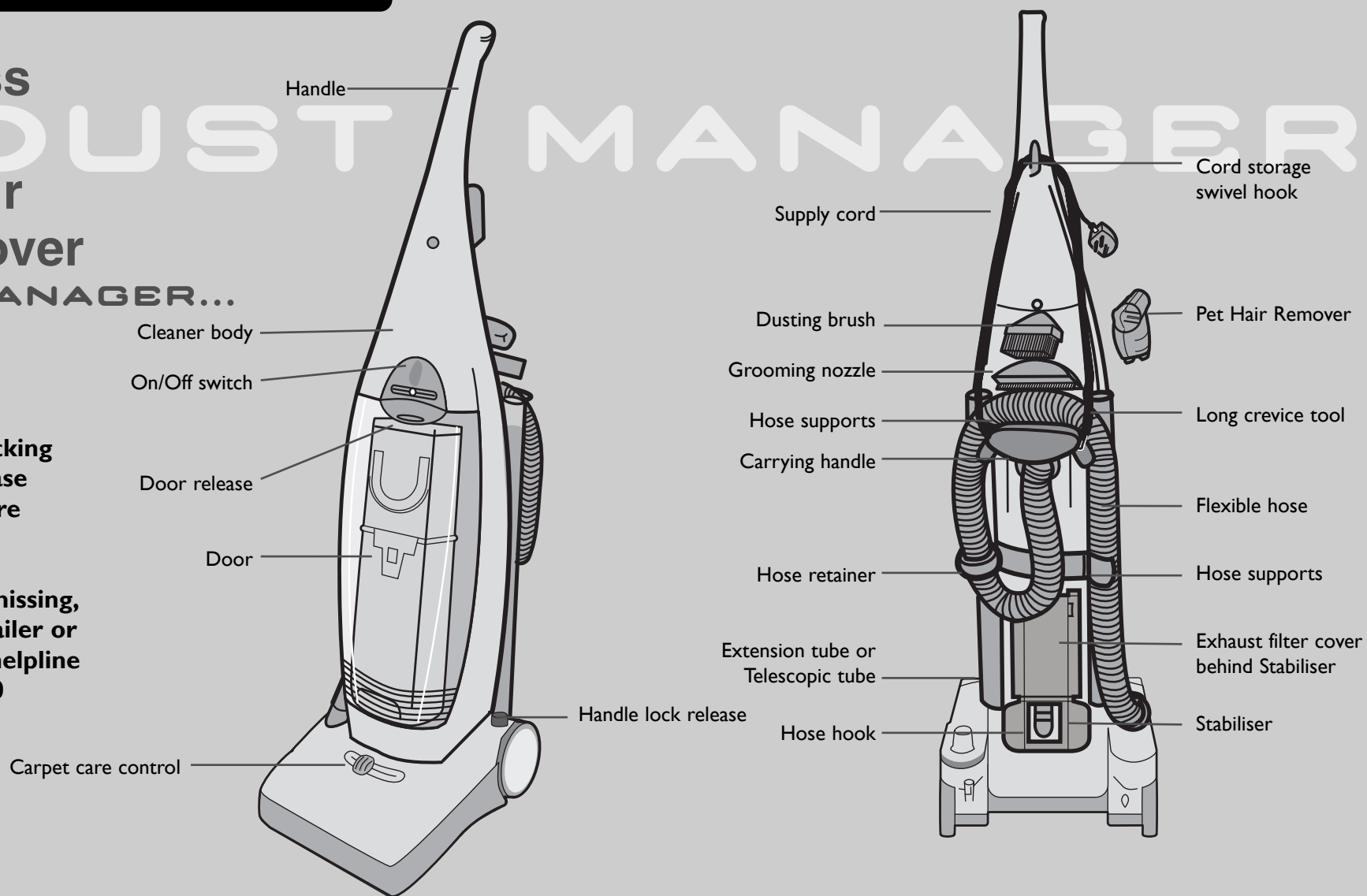

* Features vary according to model

PREPARING TO USE YOUR CLEANER

- 1 Insert handle into body of cleaner. Slide into position.

Ensure handle is flush with body of cleaner. Tighten large screw (pre-fitted to handle upper hole). Insert small screw into handle lower hole and tighten.

- 2 Locate hose end, turn clockwise to lock.
- 3 Locate hose retainer on lower hose support.
- 4 Position hose over hose supports.
- 5 Push handgrip firmly into socket.

Clip tools to back of cleaner.

Check that dust container is fitted

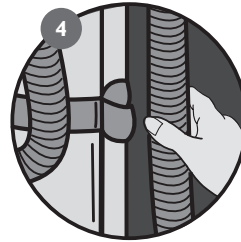
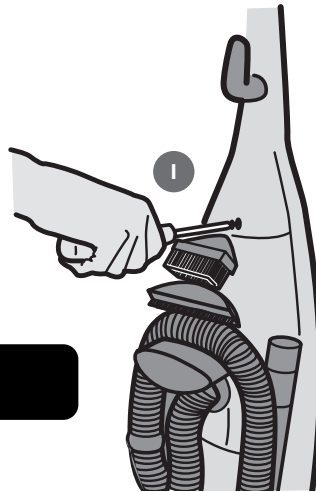
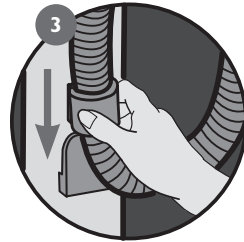

POWER SWITCH SETTING

Switching on and off

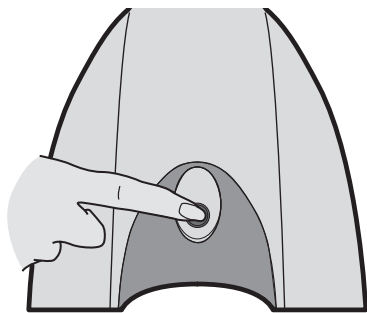

Push bottom of the switch to switch on.
Push top of switch to switch off.

CARPET HEIGHT SELECTOR

The carpet height selector raises or lowers the height of the nozzle. The nozzle height will not change until the handle is released. Try various settings until you get the best results for each of your carpets.



IMPORTANT: When cleaning hard floors such as vinyl or linoleum, move the "Height Right" selector knob to the Hard floor position. Failure to do so may cause damage to the floor surface.

Ensure that the cleaner is in an upright (parked) position.



Slide knob to position best suited to depth of carpet pile.

Using this cleaner for carpets with pile greater than 30mm is not recommended.

HANDLE LOCK RELEASE

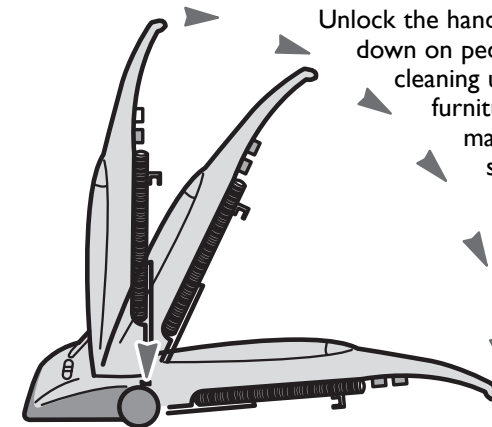

Unlock the handle by pressing down on pedal with foot. For cleaning under low furniture and some maintenance tasks simply press pedal again and lower handle to floor.

CLEANING TOOLS*



IMPORTANT: When using cleaning tools, the cleaner must be kept in the upright (parked) position, particularly when cleaning stairs. The nozzle height should also be set to tool mode:

Pet Hair Remover

Ideal for removing pet hairs.
Do not touch the rotating brush.

Telescopic Tube

Fitted on the flexible hose and with accessories at its end, its ideal for stair cleaning. It extends to minimise stretching and bending.

All accessories can fit on the end of the flexible tube. Combine accessories depending on use.

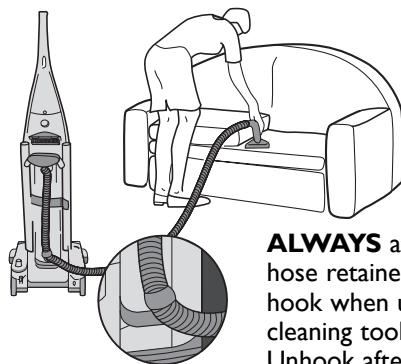

ALWAYS attach hose retainer to hose hook when using cleaning tools. Unhook after use.

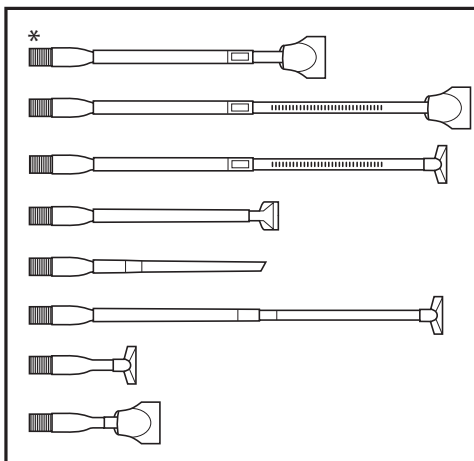

CLEANING THE STAIRS

It is dangerous for the cleaner to be above you at the top of the stairs.

ALWAYS work with the cleaner below you. Ensure it is positioned up against the bottom step.

DO NOT attach hose retainer when cleaning the stairs.

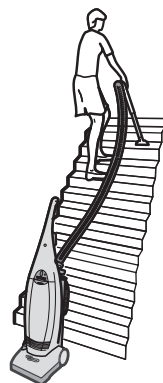

STABILISER FEATURE*

The stair STABILISER has been designed to improve cleaner stability when you pull on the hose while stair cleaning. It can be adjusted to suit any staircase.

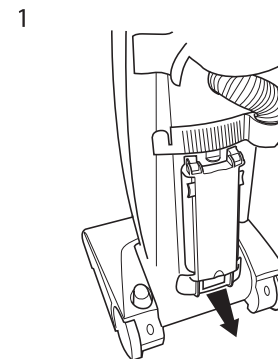

Location.

The STABILISER, stability device, is located at the back of the cleaner.

Pull the bottom of the device to release it from its storage position.

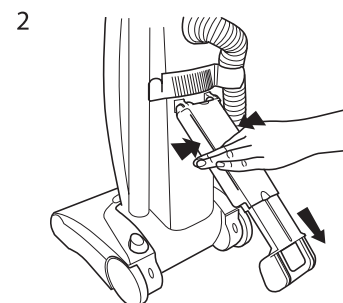

Operation.

Lift the device upwards to the position shown in the diagram. Simultaneously squeeze the finger tabs and extend the device.

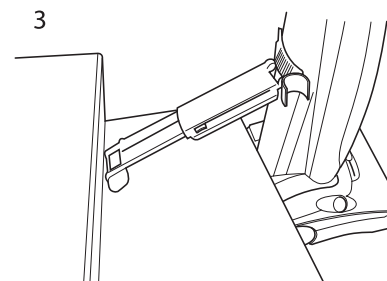

Use.

Place the cleaner against the stairs and the STABILISER in the position shown. Use the stair cleaning hose and accessories as usual. To return the cleaner to carpet mode, repeat the above process in reverse.

* Features vary according to model

CHANGING BELT OR BRUSHES

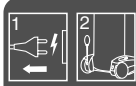

IMPORTANT: Switch cleaner off and remove plug from electricity supply before checking the brushes or removing hood.

If your cleaner is not picking up efficiently, the belt or brushes (or both) may need replacing, but first make sure you have:

- Emptied the dust container
- Cleaned filters
- Checked for blockages

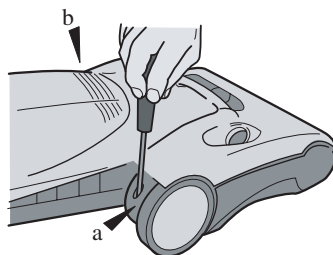

1

Remove hood

- Prise off carpet-care control knob
- Remove hood screws A and B
- Lift off hood

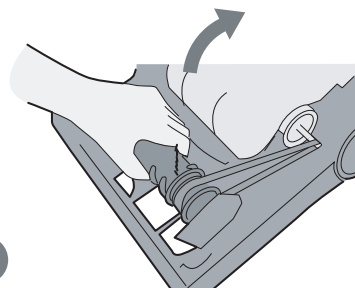

2

Remove brush assembly

- Inspect belt for signs of wear.
- To remove, pull brush cleaner assembly upwards out of cleaner housing. Remove belt from motor spindle then from brush assembly.

Replace belt

- Loop the new belt around the motor spindle then around the brush channel.

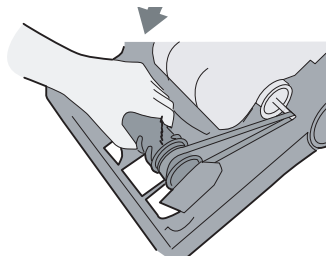

3

Refit brush assembly

- Hold the brush assembly and stretch the belt until brush mountings slot down into the cleaner housing. Rotate the brush to ensure free movement of the belt.

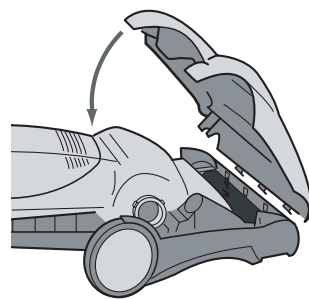

4

Refit hood

- Refit hood, ensuring the lugs along the front of hood are located in the slots along the front edge of baseplate.
- Secure hood, using screws A and B.

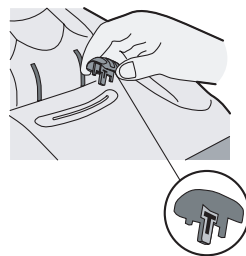

5

Refit carpet-care control knob

- Ensure the raised face (T) is towards the front of the cleaner.

Removing a blockage from the 'Pet hair remover' (certain models only)

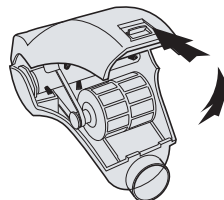

Open clip and lift cover to remove blockage.

CLEARING A BLOCKAGE*



IMPORTANT: Switch the cleaner off and remove the plug from the electricity supply before dismantling cleaner.

This cleaner is unlikely to become blocked, except by overfilling of the dust container or accidentally picking up large solid objects. Clearing a blockage is simple.

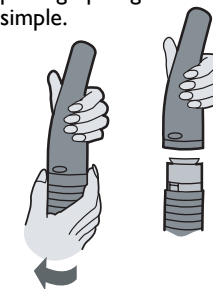

If cleaning tools were in use, check cleaning tool and extension tube first. Next check hose handgrip; to remove grip ribbed ring as shown, turn in direction of arrow and ease apart.

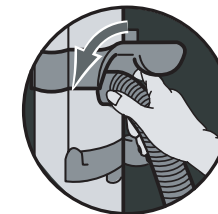

To check the hose, stretch it to full length and switch on the cleaner; the suction will dislodge most obstructions. If this is unsuccessful, switch off and unplug the cleaner. Remove the hose by turning it anti-clockwise as shown. Detach cassette and remove blockage.

For blockages in cleaner base:

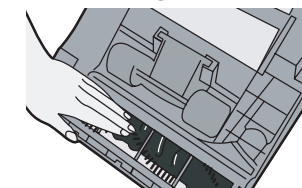

1. Turn the cleaner over and check that the brushes are free to rotate.

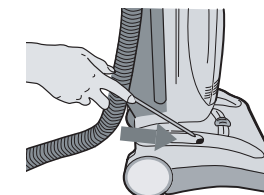

2. Check for a blockage in hose socket. Use a piece of wire or a blunt flexible rod to remove any obstructions.

Genuine HOOVER spares Tel. 01204 556 111

Always replace parts with genuine Hoover spares. These are available from your local Hoover dealer or direct from Hoover. When ordering parts always quote your model number.

Hoover service Tel. 08705 400 600

Should you require service at any time please call the HOOVER Service Office.

Hoover have a computerised nationwide service network of over 500 engineers who will respond quickly to your call and guarantee your repair for 12 months.

Hoovercare

To maintain your HOOVER product in peak condition you may also wish to take out a Hoovercare policy, for which an annual payment provides a comprehensive maintenance and repair scheme. For further information telephone the HOOVER Service Office.

Quality, Safety & Environment

As the owner of a new Hoover product we would like to tell you more about the high standards we have set in Quality, Safety and the Environment.

Quality

BSI ISO9001

Hoover's factories have been independently assessed for quality. Our products are made using a quality system which meets the requirements of ISO 9001.

Safety

Although safety certification of electrical appliances is not required by law in the UK, Hoover believe that independent approval is the best way of demonstrating safety in design and manufacture.

The British Electrotechnical Approvals Board (BEAB), the independent UK national authority for the safety of domestic electrical appliances, ensure that European Safety Standards are met and are maintained throughout the production life of the appliance.

All appliances which pass these tests are permitted to carry this BEAB mark of safety.

**BEAB
Approved**

GUARANTEE STATEMENT

The guarantee conditions for this appliance are as defined by our representative in the country in which it is sold. Details regarding these conditions can be obtained from the dealer from whom the appliance was purchased, the bill of sale or receipt must be produced when making any claim under the terms of this guarantee.

Subject to change without notice.

Use only HOOVER spares

Environment - Weee Directive



This appliance is marked according to the European Directive 2002/96/EC on Waste Electrical and Electronic Equipment (WEEE)

By ensuring this product is disposed of correctly you will help prevent potential negative consequences for the environment and human health, which could otherwise be caused by inappropriate waste handling of this product.

The symbol on the product indicates that this product may not be treated as household waste. Instead it shall be handed over to the appliance collection point for the recycling of electrical and electronic equipment.

Disposal must be carried out in accordance with local environment regulations for waste disposal.

For more detailed information about treatment, recovery and recycling of this product, please contact your local city office, your household waste disposal service or the shop where you purchased the product.

EMPTYING AND CLEANING THE DUST CASSETTE AND FILTERS*

Press down on door release pad and remove door. Pull out the dust cassette. Empty the cassette of dirt and debris. Clean cyclonic mesh after each empty.

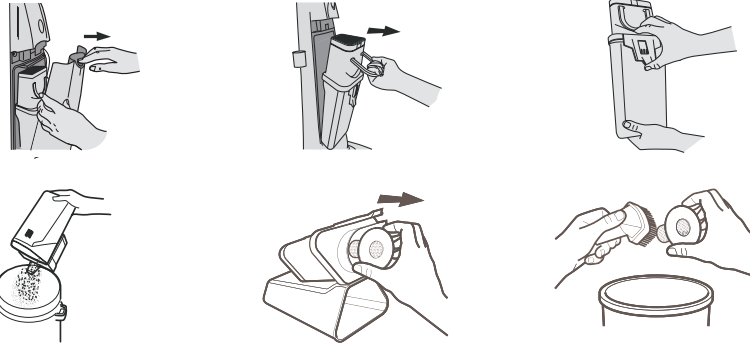

Washing cassette filter and foam:

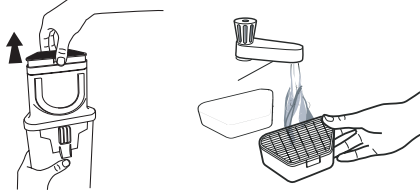

After emptying the cassette 5 times, wash the filter and foam under hand warm water. Remove excess water by shaking and leave to dry for 24 hours. Do not use a brush as this will damage the filter.

Washing pre-motor and exhaust filter:

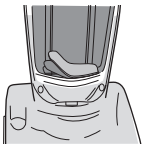

The **pre-motor filter** should be washed every three months. Wash under hand warm water. Remove excess water by shaking and leave to dry for 24 hours. When completely dry, refit the filter.

Carbon filter

Normally maintenance free, this component should not be washed. If a replacement is required please contact our spares department.

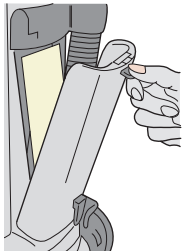

The **exhaust filter** should be washed every 3 months. Press down on the latch to remove the exhaust cover and filter. Wash under hand warm water. Remove excess water by shaking and leave to dry for 24 hours.

User checklist

If your cleaner is not working properly run through the following checklist.

1. Is there a working electricity supply to the cleaner?
check with another electrical product.
2. Is the dust container full or choked with fine dust?
To empty the dust container see the instructions on page 5.
3. Is the hose blocked?
To clear a blockage, see the instructions on page 6.
4. Is there a blockage in the cleaner base?
To clear a blockage, see the instructions on page 6.
5. Are the filters blocked?
To clear the filters, see the instructions on page 5.
6. Is the nozzle height set correctly?
To set the carpet height selector, see the instructions on page 4.
7. Are the brushes rotating correctly?
To check the brushes, see the instructions on page 6.
8. Has the cleaner overheated? If so, it will take about 30 minutes to reset itself.
If there is any doubt call the Hoover Service Office for advice. They may be able to assist you over the telephone.
A service charge will be made if the cleaner is examined and found to be in working order, has not been assembled in accordance with these instructions or has been used incorrectly.

WARNING!

A thermal cut out switches off the cleaner to prevent overheating if it is used when full or there is a blockage or dirty filters. If this should happen switch off, unplug and correct the fault.

It will take about 30 minutes for the cut out to automatically reset.

IMPORTANT: Do not run cleaner over the supply cord as this could damage the supply cord insulation.



Hoover Limited
Pentrebach
Merthyr Tydfil
Mid Glamorgan
CF48 4TU

© 2006

® Registered Trade Mark

Part Number: 0565 5214