



HOOVER

HMC440C3H-80

MICROWAVE OVENS
USER INSTRUCTIONS

GB



Microwave Oven

INSTRUCTION MANUAL

MODEL: HMC440C3H-80

Read these instructions carefully before using your microwave oven , and keep it carefully.

If you follow the instructions, your oven will provide you with many years of good service.

SAVE THESE INSTRUCTIONS CAREFULLY

PRECAUTIONS TO AVOID POSSIBLE EXPOSURE TO EXCESSIVE MICROWAVE ENERGY

- (a) Do not attempt to operate this oven with the door open since this can result in harmful exposure to microwave energy. It is important not to break or tamper with the safety interlocks.
- (b) Do not place any object between the oven front face and the door or allow soil or cleaner residue to accumulate on sealing surfaces.
- (c) **WARNING:** If the door or door seals are damaged, the oven must not be operated until it has been repaired by a competent person.

ADDENDUM

If the apparatus is not maintained in a good state of cleanliness, its surface could be degraded and affect the lifespan of the apparatus and lead to a dangerous situation.

Specifications

Model:	HMC440C3H-80
Rated Voltage:	230V~50Hz
Rated Input Power(Microwave):	1650W
Rated Output Power(Microwave):	900W
Rated Input Power(Grill):	1750W
Rated Input Power(Convection):	1750W
Oven Capacity:	44L
Turntable Diameter:	∅ 360mm
External Dimensions:	595× 568 ×454 mm
Net Weight:	Approx. 36 kg

IMPORTANT SAFETY INSTRUCTIONS

WARNING

To reduce the risk of fire, electric shock, injury to persons or exposure to excessive microwave oven energy when using your appliance, follow basic precautions, including the following:

1. Warning: Liquids and other foods must not be heated in sealed containers since they are liable to explode.
2. Warning: It is hazardous for anyone other than a competent person to carry out any service or repair operation that involves the removal of a cover which gives protection against exposure to microwave energy.
3. This appliance can be used by children aged from 8 years and above and persons with reduced physical, sensory or mental capabilities or lack of experience and knowledge if they have been given supervision or instruction concerning use of the appliance in a safe way and understand the hazards involved. Children shall not play with the appliance. Cleaning and user maintenance shall not be made by children unless they are older than 8 and supervised.
4. Keep the appliance and its cord out of reach of children less than 8 years.
5. Only use utensils suitable for use in microwave ovens.
6. The oven should be cleaned regularly and any food deposits should be removed.
7. Read and follow the specific: "PRECAUTIONS TO AVOID POSSIBLE EXPOSURE TO EXCESSIVE MICROWAVE ENERGY".
8. When heating food in plastic or paper containers, keep an eye on the oven due to the possibility of ignition.

9. If smoke is emitted, switch off or unplug the appliance and keep the door closed in order to stifle any flames.
10. Do not overcook food.
11. Do not use the oven cavity for storage purposes. Do not store items, such as bread, cookies, etc. inside the oven.
12. Remove wire twist-ties and metal handles from paper or plastic containers/bags before placing them in the oven.
13. Install or locate this oven only in accordance with the installation instructions provided.
14. Eggs in the shell and whole hard-boiled eggs should not be heated in microwave ovens since they may explode, even after microwave heating has ended.
15. This appliance is intended to be used in household and similar applications such as:
 - staff kitchen areas in shops, offices and other working environments;
 - by clients in hotels, motels and other residential type environments;
 - farm houses;
 - bed and breakfast type environments.
16. If the supply cord is damaged, it must be replaced by the manufacturer, its service agent or similarly qualified persons in order to avoid a hazard.
17. Do not store or use this appliance outdoors.
18. Do not use this oven near water, in a wet basement or near a swimming pool.
19. The temperature of accessible surfaces may be high when the appliance is operating. The surfaces are liable to get hot during use. Keep cord away from heated surface, and do not cover any vents on the oven.

20. Do not let cord hang over edge of table or counter.
21. Failure to maintain the oven in a clean condition could lead to deterioration of the surface that could adversely affect the life of the appliance and possibly result in a hazardous situation.
22. The contents of feeding bottles and baby food jars shall be stirred or shaken and the temperature checked before consumption, in order to avoid burns.
23. Microwave heating of beverages can result in delayed eruptive boiling, therefore care must be taken when handling the container.
24. The appliance is not intended for use by persons (including children) with reduced physical, sensory or mental capabilities, or lack of experience and knowledge, unless they have been given supervision or instruction concerning use of the appliance by a person responsible for their safety.
25. Children should be supervised to ensure that they do not play with the appliance.
26. The appliances are not intended to be operated by means of an external timer or separate remote-control system.
27. Accessible parts may become hot during use. Young children should be kept away.
28. Steam cleaner is not to be used.
29. During use the appliance becomes hot. Care should be taken to avoid touching heating elements inside the oven.
30. Only use the temperature probe recommended for this oven. (for ovens provided with a facility to use a temperature-sensing probe.)

- 31.WARNING: The appliance and its accessible parts become hot during use.Care should be taken to avoid touching heating elements. Children less than 8 years of age shall be kept away unless continuously supervised.
- 32.The microwave oven must be operated with the decorative door open.(for ovens with a decorative door.)
- 33.Surface of a storage cabinet can get hot.

READ CAREFULLY AND KEEP FOR FUTURE REFERENCE

To Reduce the Risk of Injury to Persons Grounding Installation

DANGER

Electric Shock Hazard
Touching some of the internal components can cause serious personal injury or death. Do not disassemble this appliance.

WARNING

Electric Shock Hazard
Improper use of the grounding can result in electric shock.

This appliance must be grounded. In the event of an electrical short circuit, grounding reduces the risk of electric shock by providing an escape wire for the electric current.

Consult a qualified electrician or serviceman if the grounding instructions are not completely understood or if doubt exists as to whether the appliance is properly grounded. If it is necessary to use an extension cord, use only a 3-wire

1. A short power-supply cord is provided to reduce the risks resulting from becoming entangled in or tripping over a longer cord.
2. If a long cord set or extension cord is used:
 - 1) The marked electrical rating of the cord set or extension cord should be at least as great as the electrical rating of the appliance.
 - 2) The extension cord must be a grounding-type 3-wire cord.
 - 3) The long cord should be arranged so that it will not drape over the counter top or tabletop where it can be pulled on by children or tripped over unintentionally.

CLEANING

1. Clean the cavity of the oven after using with a slightly damp cloth.
2. Clean the accessories in the usual way in soapy water.
3. The door frame and seal and neighbouring parts must be cleaned carefully with a damp cloth when they are dirty.
4. Do not use harsh abrasive cleaners or sharp metal scrapers to clean the oven door glass since they can scratch the surface, which may result in shattering of the glass.
5. Cleaning Tip---For easier cleaning of the cavity walls that the food cooked can touch: Place half a lemon in a bowl, add 300ml (1/2 pint) water and heat on 100% microwave power for 10 minutes. Wipe the oven clean using a soft, dry cloth.

UTENSILS

CAUTION

Personal Injury Hazard

It is hazardous for anyone other than a competent person to carry out any service or repair operation that involves the removal of a cover which gives protection against exposure to microwave energy.

See the instructions on "Materials you can use in microwave oven or to be avoided in microwave oven." There may be certain non-metallic utensils that are not safe to use for microwaving. If in doubt, you can test the utensil in question following the procedure below.

Utensil T test:

1. Fill a microwave-safe container with 1 cup of cold water (250ml) along with the utensil in question.
2. Cook on maximum power for 1 minute.
3. Carefully feel the utensil. If the empty utensil is warm, do not use it for microwave cooking.
4. Do not exceed 1 minute cooking time.

Materials you can use in microwave oven

Utensils	Remarks
Browning dish	Follow manufacturer's instructions. The bottom of browning dish must be at least 3/16 inch (5mm) above the turntable. Incorrect usage may cause the turntable to break.
Dinnerware	Microwave-safe only. Follow manufacturer's instructions. Do not use cracked or chipped dishes.
Glass jars	Always remove lid. Use only to heat food until just warm. Most glass jars are not heat resistant and may break.
Glassware	Heat-resistant oven glassware only. Make sure there is no metallic trim. Do not use cracked or chipped dishes.
Oven cooking bags	Follow manufacturer's instructions. Do not close with metal tie. Make slits to allow steam to escape.
Paper plates and cups	Use for short-term cooking/warming only. Do not leave oven unattended while cooking.
Paper towels	Use to cover food for reheating and absorbing fat. Use with supervision for a short-term cooking only.
Parchment paper	Use as a cover to prevent splattering or a wrap for steaming.
Plastic	Microwave-safe only. Follow the manufacturer's instructions. Should be labeled "Microwave Safe". Some plastic containers soften, as the food inside gets hot. "Boiling bags" and tightly closed plastic bags should be slit, pierced or vented as directed by package.
Plastic wrap	Microwave-safe only. Use to cover food during cooking to retain moisture. Do not allow plastic wrap to touch food.
Thermometers	Microwave-safe only (meat and candy thermometers).
Wax paper	Use as a cover to prevent splattering and retain moisture.

Materials to be avoided in microwave oven

Utensils	Remarks
Aluminum tray	May cause arcing. Transfer food into microwave-safe dish.
Food carton with metal handle	May cause arcing. Transfer food into microwave-safe dish.
Metal or metal-trimmed utensils	Metal shields the food from microwave energy. Metal trim may cause arcing.
Metal twist ties	May cause arcing and could cause a fire in the oven.
Paper bags	May cause a fire in the oven.
Plastic foam	Plastic foam may melt or contaminate the liquid inside when exposed to high temperature.
Wood	Wood will dry out when used in the microwave oven and may split or crack.

SETTING UP YOUR OVEN

Names of Oven Parts and Accessories

Remove the oven and all materials from the carton and oven cavity

Your oven comes with the following accessories:

Enamel Tray	1
Turntable ring assembly	1
Instruction Manual	1

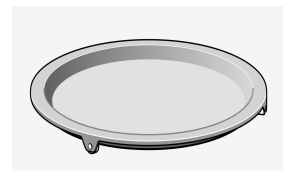
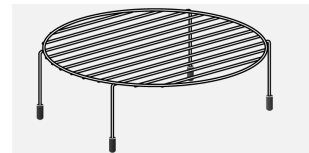
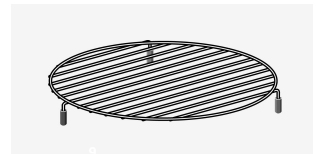
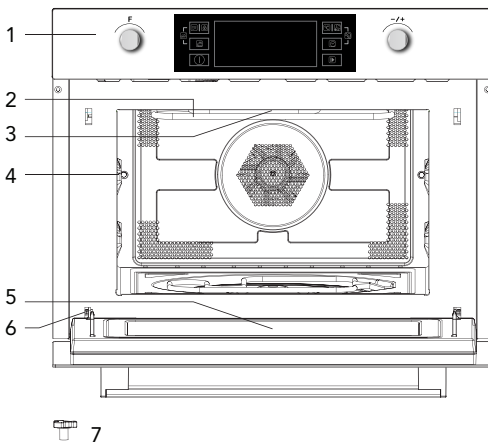

- | | |
|--------------------|---------------------|
| 1. Control panel | 8. Short Grill Rack |
| 2. Grill element | 9. Long Grill Rack |
| 3. Light | 10. Grill Pan |
| 4. Level | |
| 5. Door glass | |
| 6. Hinge | |
| 7. Turntable shaft | |

Turntable Installation

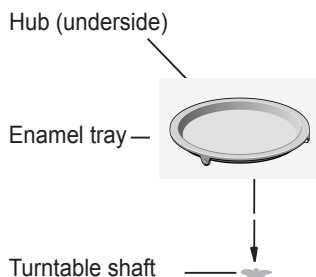

- Never place the enamel tray upside down. The enamel tray should never be restricted.
- The enamel tray must always be used during cooking.
- All food and containers of food are always placed on the enamel tray for cooking.
- If enamel tray cracks or breaks, contact your nearest authorized service center.

Important information about installing

- This appliance is NOT intended for use in a commercial environment.
- Please observe the installation instructions provided and note that this appliance should only be installed by a qualified technician.
- Adapters, multiway strips and extension cords must not be used. Overloading can result in fire.

The accessible surface may be hot during operation.



Placement

- Danger! Do not disassemble this appliance. Touching internal components of this appliance can cause serious personal injury or death.
- Place the microwave oven on a firm, flat surface.
- Make sure that there is sufficient ventilation around the microwave oven. At the rear and sides keep at least 10 cm free.
- Do not cover the air vents.
- The adjustable feet should not be removed.
- Do not place the microwave oven near a heat source.
- Transmitting and receiving equipment such as radios and televisions can affect the operation of the microwave oven.

Installation dimensions

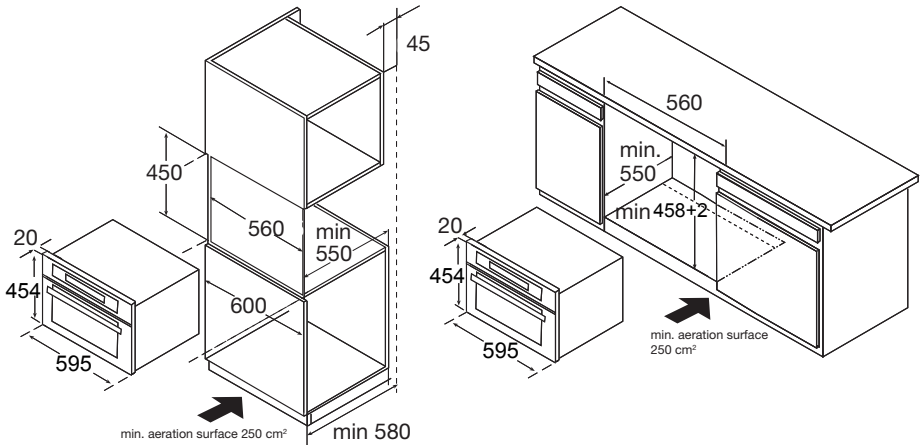

Note: There should be gap above the oven.

Building in

- Do not hold or carry the appliance by the door handle. The door handle cannot hold the weight of the appliance and may break off.
1. Carefully push the microwave into the box, making sure that it is in the centre.
 2. Open the door and fasten the microwave with the screws that were supplied.

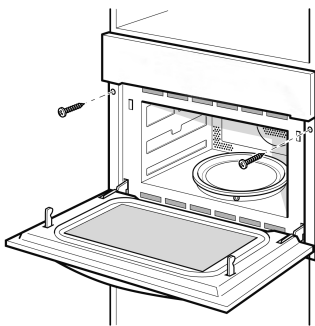

INSTALL THE TRAY

1. Check the position of the shaft.

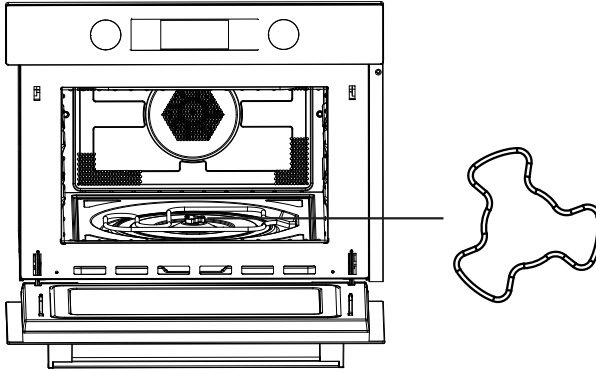

2. Adjust the angle of the tray, the tray roller should point to one of the shaft arm.

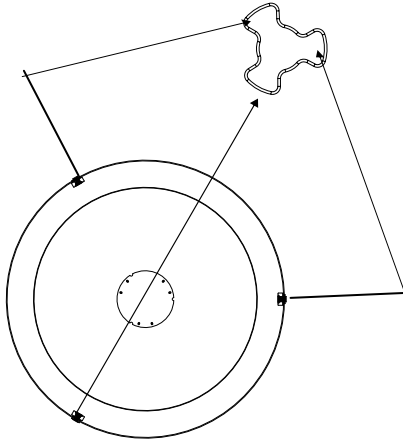

3. Put the tray on the shaft and adjust slightly .

OPERATION

Control Panel and Features

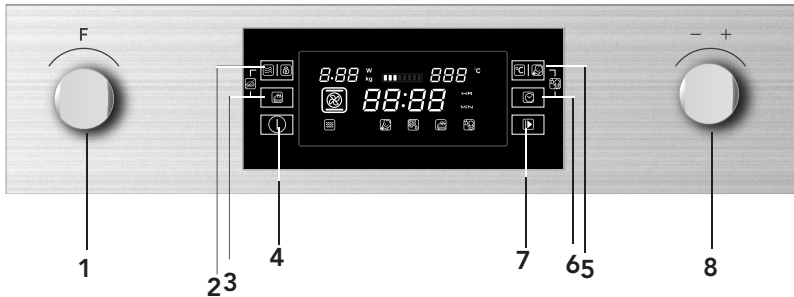



- 1) Function knob
- 2) Power/Weight button
- 3) Quickly preheating button
- 4) On/Off Button
- 5) Temperature/automenu button
- 6) Clock button
- 7) Start/Pause button
- 8) Selection knob

OPERATION INSTRUCTION



This microwave oven uses modern electronic control to adjust cooking parameters to meet your needs better for cooking.



1. Clock Setting

When the microwave oven is electrified, "00:00" will blink, buzzer will ring once.







- 1) Turn  knob to set the right time (between 00:00 and 23:59.)
- 2) After you have set the right time, press "  ". The clock has been set.

Note: 1) If you want to change the time, you have to press and hold the "  " button for 3 seconds. The actual time disappears and then the time will blink in the display.

Turn  knob to set the new time and press the "  " button to confirm the setting.

- 2) If you do not want to see the clock in the display, press "  " button briefly. The time disappears. Press "  " again, and the clock appears in the display again.

2. Microwave Cooking

- 1) Press the "  " button to activate the microwave function. "01:00" is blinking in the display and the microwave icon appears. If no operation in 10 seconds, the current power will be confirmed automatically.
- 2) Turn  knob to set the cooking time.
The max. cooking time depends on the power that has been set. When the power is 900W, the MAX. time is 30 minutes and other powers are 90 minutes.
- 3) Press "  |  " button to adjust the power microwave power.
- 4) Turn  knob to set the microwave power (between 100W to 900W)
- 5) Press "  " button to start cooking.

NOTE: the step quantities for the adjustment time of the coding switch are as follow:

0---1 min	: 1 second
1---5 min	: 10 seconds
5---15 min	: 30 seconds
15---60 min	: 1 minute
60 min	: 5 minutes







Microwave Power Chart











Microwave Power	100%	80%	50%	30%	20%
Display	900W	700W	450W	300W	100W

You can see from the table below from which power levels you can choose and for which foods the power levels are suitable.











Power level	Food
900 W	- Boiling water, reheating - Cooking chicken, fish, vegetables
700 W	- Reheating - Cooking mushrooms, shell fish - Cooking dishes containing eggs and cheese
450 W	- Cooking rice, soup
300 W	- Defrosting - Melting chocolate and butter
100 W	- Defrosting sensitive/delicate foods - Defrosting irregularly-shaped foods - Softening ice cream - Allowing dough to rise

Functions











Function		Mode		
	Microwave		Microwave	Microwave Use the microwave function to cook and reheat vegetables, potatoes, rice, fish and meat.
	Heating		Hot air	Hot air With hot air you can prepare meals in the same way as you do with a conventional oven. The microwave is not activated. You are advised to preheat the oven before putting the meal in the oven.
			Grill with fan	Grill with fan Use this function to roast meals evenly and at the same time give the meal a brown crust.
			Grill	Grill The grill is very suitable to prepare thin pieces of meat and fish.

Function		Mode		
	Heating		Hot air+ Bottom heat	Use this function to roast big pieces of meat, pizza, etc.
			Double grill	Use this function to roast big pieces of meat, pizza, etc.
	Combination		Hot air	Microwave + Hot air Use this function to roast meals quickly.
			Grill with fan	Microwave + Grill with fan
			Grill	Microwave + Grill Use this function to cook meals quickly and at the same time give the meal a brown crust (also au gratin). The microwave and the grill are activated at the same time. The microwave is cooking and the grill is roasting.
			Hot air+ Bottom heat	Use this function to roast big pieces of meat, pizza, etc.
			Double grill	Use this function to roast big pieces of meat, pizza, etc.
	Auto-programs		P01 - P13	Automatic cooking programs
	Defrost		d01 + d02	Defrost











3. Grill Cooking

- 1) Press "  " button to activate the microwave function.
- 2) Turn "  " to select the cooking mode.
- 3) Turn "  " to select grill mode. The default grill power is the third level.
"  " indicator will light when grill function is selected.
- 4) Press "   " to enter to the grill level.
- 5) Turn "  " to select the level 3(the MAX.), level 2 or level 1(the MIN.).
Press "  " to select the time setting mode. The default time is 10 minutes.
- 6) Turn "  " to select the cooking time of grill. The MAX.time is 90 minutes.
- 7) Press "  " button to start cooking.











4. Convection Cooking

- 1) Press "  " button to activate the microwave function.
- 2) Turn "  " to select the cooking mode.
- 3) Turn "  " to select convection mode. "  " lights.
The default temperature is 180 degrees..
- 4) Press "   " to enter the temperature mode.
- 5) Turn "  " to select temperature. The temperature is from 50 to 230 degrees.
Press "  " to select the time setting mode. The default time is 10 minutes.
- 6) Turn "  " to select the cooking time. The MAX.time is 5 hours.
- 7) Press "  " button to start cooking.







5. Grill Fan Cooking

- 1) Press "  " button to activate the microwave function.
- 2) Turn "  " to select the cooking mode.
- 3) Turn "  " to select grill fan mode. The default temperature is 180 degrees.
"  " indicator will light when grill fan function is selected.
- 4) Press "   " to enter the temperature selection.
- 5) Turn "  " to select the temperature between 100 to 230 degrees.
The temperature are 100,105,110,115,120,125,130,135,140,145,150,155,160,165,170,175,180,185,190,195,200,205,210,215,220,225,230.
Press"  " to select the time setting mode. The default time is 10 minutes.
- 6) Turn "  " to select the cooking time. The MAX.time is 5 hours.
- 7) Press "  " button to start cooking.















6. Convection+ Bottom heat Cooking

- 1) Press "  " button to activate the microwave function.
- 2) Turn "  " to select cooking mode.
- 3) Turn "  " to select bottom+ convection mode.
The default temperature is 180 degrees.
"  " indicator will light when convection + bottom function is selected.
- 4) Press "   " to enter the temperature selection.
- 5) Turn "  " to select the temperature between 100 to 230 degrees.
The temperature are 100,105,110,115,120,125,130,135,140,145,150,155,160,165,170,175,180,185,190,195,200,205,210,215,220,225,230.
press"  " to select the time setting mode. The default time is 10 minutes.
- 6) Turn "  " to select the cooking time. The MAX.time is 5 hours.
- 7) Press "  " button to start cooking.















7. Double Grill Cooking

- 1) Press "  " button to activate the microwave function.
- 2) Turn "  " to select the cooking mode.
- 3) Turn "  " to select grill mode.
"  " indicator will light when grill function is selected.
- 4) Press "  " to select the time setting mode. The default time is 10 minutes.
- 5) Turn "  " to select the cooking time of double grill.
The MAX.time is 90 minutes.
- 6) Press "  " button to start cooking.















8. Microwave + Grill Cooking

- 1) Press "  " button to activate the microwave function.
- 2) Turn "  " to select the combination mode."  " will light.
- 3) Turn "  " to select mode. The default power is level 3.
"  " indicator will light when grill function is selected.
- 4) Press "  |  " to enter to the temperature selection.
- 5) Turn "  " to select the power.
- 6) Press "  |  " to select the power. The default power is 300W
- 7) Turn "  " to select 700W,450W,300W and 100W.
- 8) Press"  " to select the time setting mode. The default time is 10 minutes.
- 9) Turn "  " to select the cooking time. The MAX.time is 90 minutes.
- 10) Press "  " button to start cooking.















9. Microwave + Convection Cooking

- 1) Press "  " button to activate the microwave function.
- 2) Turn "  " to select the cooking mode. "  " will light.
- 3) Turn "  " to select convection mode. The default temperature is 180 degrees.
"  " lights.
- 4) Press "  |  " to enter to the temperature selection.
- 5) Turn "  " to select the temperature between 50 to 230 degrees.
- 6) Press "  |  " to select the power. The default power is 300W
- 7) Turn "  " to select 700W,450W,300W and 100W.
- 8) Press "  " to select the time setting mode. The default time is 10 minutes.
- 9) Turn "  " to select the cooking time of grill. The MAX.time is 90 minutes.
- 10) Press "  " button to start cooking.











10. Microwave + Grill Fan Cooking

- 1) Press "  " button to activate the microwave function.
- 2) Turn "  " to select the combination mode."  " will light.
- 3) Turn "  " to select cooking mode. The default temperature is 180 degrees.
"  " indicator will light when this function is selected.
- 4) Press "  |  " to enter to the temperature selection.
- 5) Turn "  " to select the temperature between 100 to 230 degrees.
- 6) Press "  |  " to select the power. The default power is 300W
- 7) Turn "  " to select 700W,450W,300W and 100W.
- 8) Press "  " to select the time setting mode. The default time is 10 minutes.
- 9) Turn "  " to select the cooking time of grill. The MAX.time is 90 minutes.
- 10) Press "  " button to start cooking.

11. Microwave + Bottom + Convection Cooking

- 1) Press "  " button to activate the microwave function.
- 2) Turn "  " to select the combination mode. "  " will light.
- 3) Press "  " to select convection mode. The default temperature is 180 degrees.
"  " indicator will light when this function is selected.
- 4) Press "  |  " to enter to the temperature selection.
- 5) Press "  " to select the temperature between 100 to 230 degrees.
- 6) Press "  |  " to select the power. The default power is 300W
- 7) Press "  " to select 700W,450W,300W and 100W.
- 8) Turn "  " to select the time setting mode. The default time is 10 minutes.
- 9) Press "  " to select the cooking time of grill. The MAX.time is 90 minutes.
- 10) Press "  " button to start cooking.



12. Microwave + Double Grill Cooking

- 1) Press "  " button to activate the microwave function.
- 2) Turn "  " to select the combination mode. "  " will light.
- 3) Turn "  " to select mode.
"  " indicator will light when grill function is selected.
- 4) Press "  |  " to select the power. The default power is 300W.
- 5) Turn "  " to select 700W,450W,300W and 100W.
- 6) Press "  " to select the time setting mode. The default time is 10 minutes.
- 7) Turn "  " to select the cooking time. The MAX.time is 90 minutes.
- 8) Press "  " button to start cooking.

13. Auto Cook

There are 15 automatic cooking programs. You only have to choose the program and set the weight. The power, the time and the temperature are already set.

1) Press "  " button to activate the microwave function.

2) Turn "  " to select the cooking mode. "  " or "  " will light when defrost or auto menu selected.

Time, weight, the first number of the automatic programs are shown in the display.

3) Turn "  " to select auto menu. " d01", "d02" or "P01", "P02"...."P13" will display.

4) Press "  |  " button.

5) Turn "  " to select weight of the menu.





6) Press "  " button to start cooking.

Program	Category	Item
d01 (defrost)**	Meat, poultry and fish	If you hear a beep, the combi microwave oven stops. Turn the food and press the start/pause button to continue the defrosting program.
d02 (defrost)**	Bread, cake and fruit	
P01**	Vegetables	Fresh vegetables
P02**	Side dishes	Potatoes - peeled/cooked
P03*	Side dishes	Potatoes - roasted If you hear a beep, turn the food. The combi microwave oven starts the next fase automatically.
P04	Poultry/ Fish	Chicken pieces/ Fish pieces If you hear a beep, turn the food. The combi microwave oven starts the next fase automatically.
P05*	Bakery	Cake
P06*	Bakery	Apple pie
P07*	Bakery	Quiche
P08**	Reheat	Drink/soup
P09**	Reheat	Plated meal
P10**	Reheat	Sauce/stew/dish
P11*	Convenience	Frozen - pizza
P12*	Convenience	Oven chips If you hear a beep, turn the food. The combi microwave oven starts the next fase automatically.
P13*	Convenience	Frozen - lasagne

- The programmes with a * are preheated. During preheating, the cooking time pauses and the preheating symbol is on. After preheating, you will hear an alarm and the preheating symbol will blink.
- The programmes with ** only use the microwave function.

14. Preheating Function





The preheating function can be activated after you have chosen the functions: Convection, Grill fan, bottom -convection, MW-convection, MW-Grill fan and Microwave -Bottom-convection.

- 1) Press "  " button. The preheating icon appears in the display.
- 2) Press "  " button to start preheating. You can stop the preheating by opening the oven door or by pressing the "  " button.
- 3) When the set temperature is reached, you will hear three beeps and preheat icon will flash.
- 4) Open the oven door, put the food into the oven and close the door.
Press the "  " button to start cooking, preheating icon go off.
If you don't press "  ", the oven will go back to clock states.

Note: The preheating function only works if you have already chosen one of the modes above. During preheating, the microwave function is switched off.

15. Lock-out Function for Children

Lock: In waiting state, press "  " and "  |  " at the same time, there will be a long "beep" denoting entering into the children-lock state and "  " indicator will light.

Unlock : In locked state, press "  " and "  |  " for 3 seconds, there will be a long "beep" denoting that the lock is released, and "  " indicator will disappear.

16. Control oven lamp and turntable tray

During the microwave, grill and combination cooking, you can switch the oven lamp and turntable tray working condition by press "  |  " and "  " at the same time.

Cooking mode	Default mode	Switch mode
Microwave	Turntable tray rotating, oven lamp on	Turntable tray not rotating, oven lamp off
grill	Turntable tray rotating, oven lamp on	Turntable tray not rotating, oven lamp off
combination	Turntable tray rotating, oven lamp on	Turntable tray not rotating, oven lamp off

17. Display Specification

- (1) When setting, if no other operation, it will confirm automatically after 10 seconds.
Except clock setting for the first time.
- (2) During setting program, after adjusted for 3 seconds, it will confirm after 3 seconds.
- (3) The oven lamp will light all the time if the door is open.
- (4) When the oven is in setting state or pause state, including auto menu and defrost program, if no operation in 15 minutes, it will enter into the off state.
- (5) "  " button must be pressed to continue cooking if the oven door is open during cooking process.

Trouble shooting

Normal	
Microwave oven interfering TV reception	Radio and TV reception may be interfered when microwave oven operating. It is similar to the interference of small electrical appliances, like mixer, vacuum cleaner, and electric fan. It is normal.
Dim oven light	In low power microwave cooking, oven light may become dim. It is normal.
Steam accumulating on door, hot air out of vents	In cooking, steam may come out of food. Most will get out from vents. But some may accumulate on cool place like oven door. It is normal.
Oven started accidentally with no food in.	It is forbidden to run the unit without any food inside. It is very dangerous.

Trouble	Possible Cause	Remedy
Oven can not be started.	(1) Power cord not plugged in tightly.	Unplug. Then plug again after 10 seconds.
	(2) Fuse blowing or circuit breaker works.	Replace fuse or reset circuit breaker (repaired by professional personnel of our company)
	(3) Trouble with outlet.	Test outlet with other electrical appliances.
Oven does not heat.	(4) Door not closed well.	Close door well.

CUSTOMER ASSISTANCE SERVICE

If you cannot identify the cause of the operating anomaly: switch off the appliance (do not subject it to rough treatment) and contact the Assistance Service.

PRODUCT SERIAL NUMBER. Where can I find it?

It is important that you to inform the Assistance Service of your product code and its serial number (a 16 character code which begins with the number 3); this can be found on the guarantee certificate or on the data plate located on the appliance.

It will help to avoid wasted journeys to technicians, thereby (and most significantly) saving the corresponding callout charges.



According to Waste of Electrical and Electronic Equipment (WEEE) directive, WEEE should be separately collected and treated. If at any time in future you need to dispose of this product please do NOT dispose of this product with household waste. Please send this product to WEEE collecting points where available.