

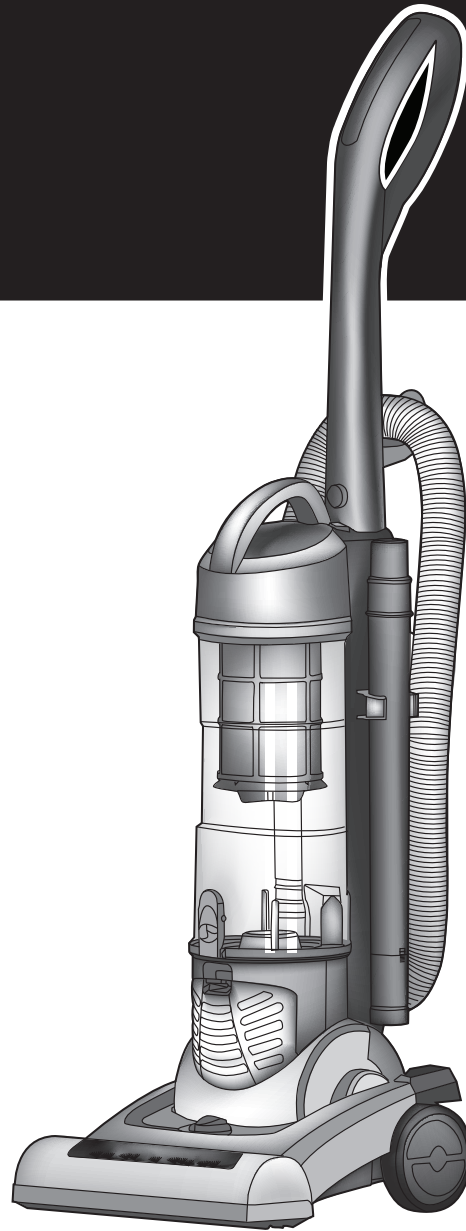

®

GENERATION FUTURE

HOOVER



USER MANUAL

IMPORTANT SAFETY REMINDERS

This appliance should only be used for domestic cleaning, as described in this user guide. Please ensure that this guide is fully understood before operating the appliance.

Do not leave the appliance plugged in. Always switch off and remove the plug from the socket after use, or before cleaning the appliance or any maintenance task.

This appliance can be used by children aged from 8 years and above and persons with reduced physical, sensory or mental capabilities or lack of experience and knowledge if they have been given supervision or instruction concerning use of the appliance in a safe way and understand the hazards involved. Children shall not play with the appliance. Cleaning and user maintenance shall not be made by children without supervision.

If the power cord is damaged stop using the appliance immediately. To avoid a safety hazard, an authorised Hoover service engineer must replace the power cord.

Keep hands, feet, loose clothing and hair away from rotating brushes.

Use only attachments, consumables or spares recommended or supplied by Hoover.

When using cleaning tools ensure that the appliance is kept in the upright (parked) position. This will avoid possible damage to the carpet or floor covering. When cleaning stairs, do not position the appliance above you.

Static electricity: some carpets can cause a small build up of static electricity. Any static discharge is not hazardous to health.

Do not use your appliance out of doors or on any wet surface or for wet pick up.

Do not pick up hard or sharp objects, matches, hot ashes,

cigarette ends or other similar items.

Do not spray with or pick up flammable liquids, cleaning fluids, aerosols or their vapours.

Do not run over the power cord when using your appliance or remove the plug by pulling on the power cord.

Do not continue to use your appliance if it appears faulty.

Hoover service: To ensure the continued safe and efficient operation of this appliance we recommend that any servicing or repairs are only carried out by an authorised Hoover service engineer.

Do not stand on or wrap the cord around arms or legs when using your appliance.

Do not use the appliance to clean animals or people.

When using the cleaning tools, ensure to always steady the appliance with your other hand. This will ensure that the appliance does not fall while in use.

WARNING: A thermal cut out switches off the appliance to prevent overheating if it is used when full or there is a blockage or dirty filters. If this should happen then switch off, unplug and correct the fault. It will take approximately 45 minutes for the cut out to automatically reset.

The Environment

The symbol on this appliance indicates that this appliance may not be treated as household waste. Instead it must be handed over to the applicable collection point for the recycling of electrical and electronic equipment. Disposal must be carried out in accordance with local environmental regulations for waste disposal. For more detailed information about treatment, recovery and recycling of this appliance, please contact your local city office, your household and waste disposal service or the shop where you purchased the appliance.



 This appliance complies with the European Directives 2006/95/EC, 2004/108/EC and 2011/65/EU.

HOOVER Limited, Pentrebach, Merthyr Tydfil, Mid Glamorgan, CF48 4TU, UK

GETTING TO KNOW YOUR CLEANER

**Effortless
cleaning
with your
new Hoover**

**This vacuum cleaner is
supplied with an Energy
Label as required by
European Regulation (EU)
665/2013.**

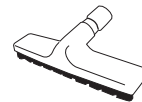
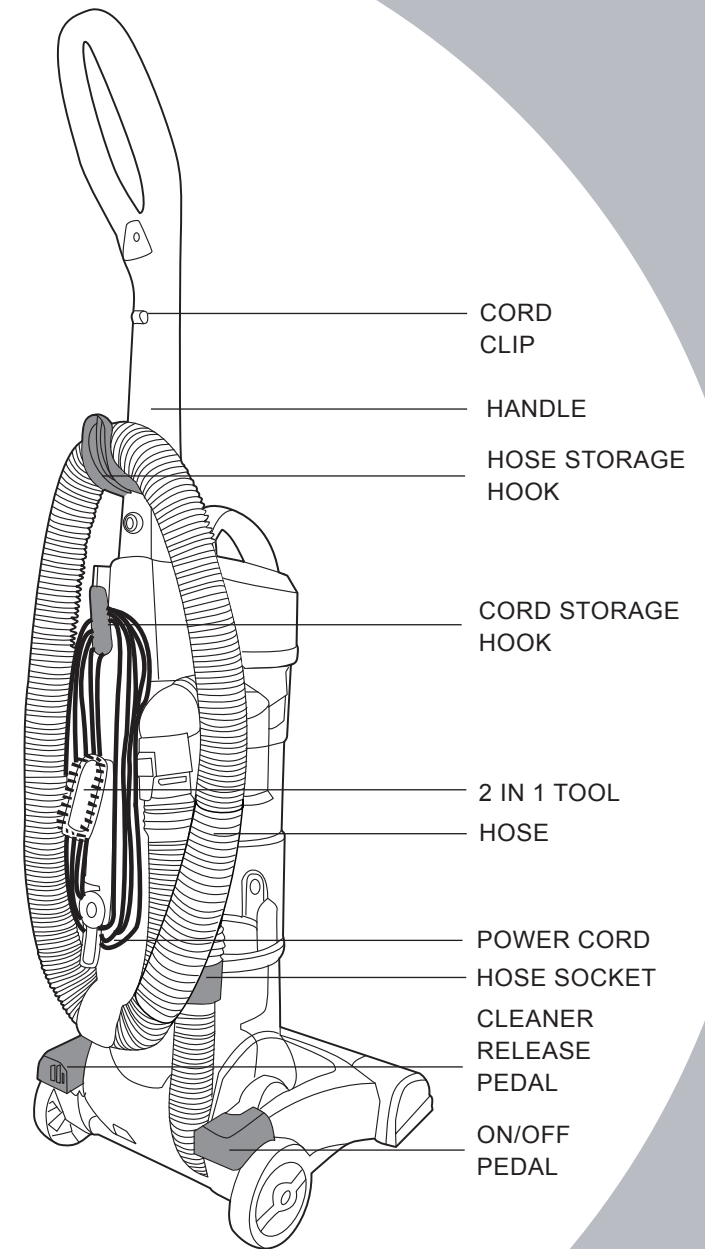
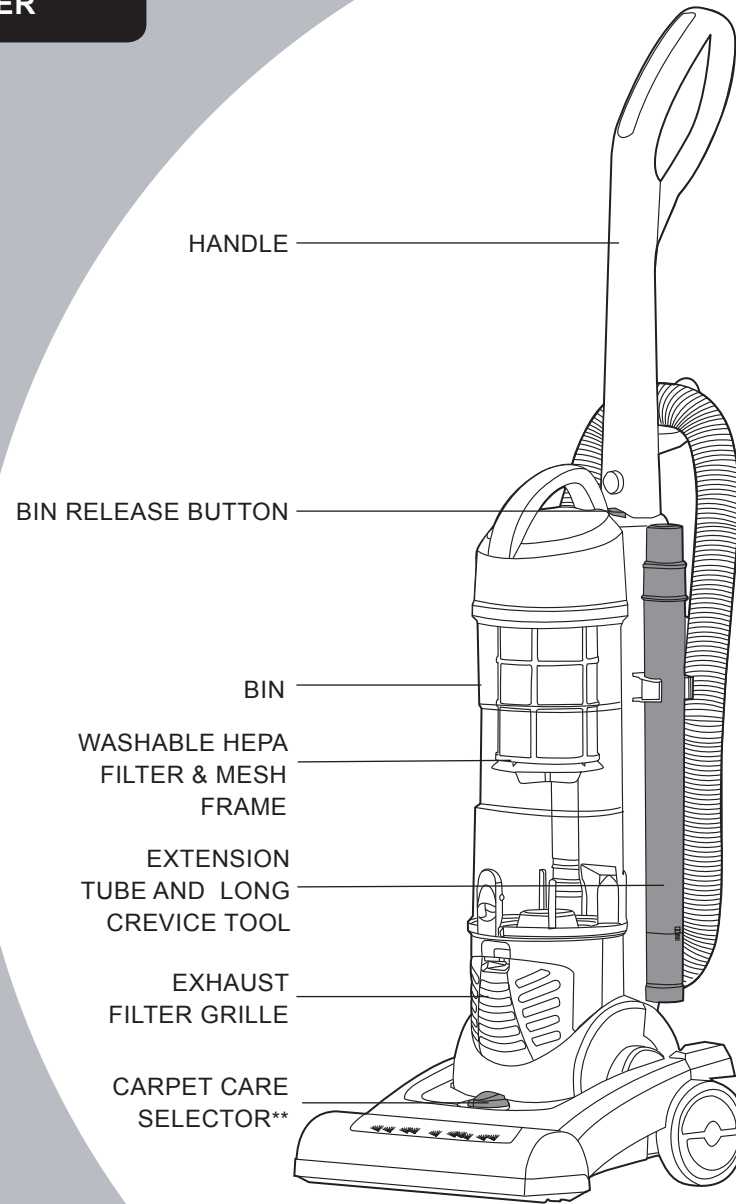

PARQUET NOZZLE*



PET HAIR & ALLERGEN REMOVER*

* Certain models only

**Selector design, top of the bin and handle may vary according to models.

PREPARING YOUR CLEANER

Insert the main handle in the cleaner body and then fix it with the screw provided. To tighten the screw you can use a standard coin.

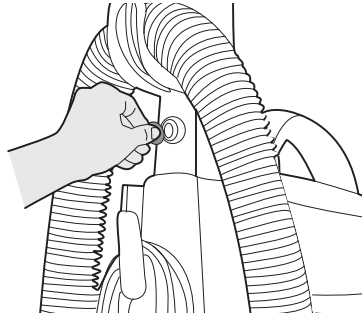

SUPPLY CORD

Do not run over the supply cord.

Clip the supply cord in the cord clip at the back of the handle to avoid accidentally running the cleaner over the cord and causing any damage.

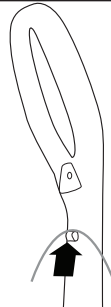

CARPET CARE CONTROL SELECTOR

The carpet care control selector raises and lowers the height of the nozzle.

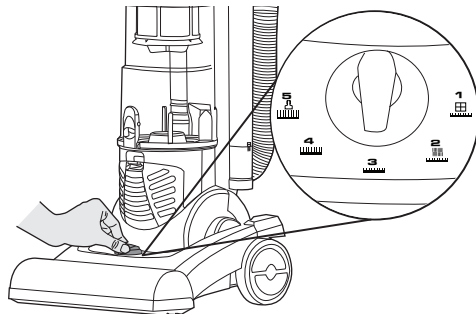

* Certain models only

CARPET CARE CONTROL SELECTOR

Ensure that the cleaner is in the upright (parked) position and move the selector to the required setting for the carpet type or floor covering.

To obtain the best performance and energy efficiency ^{#1} it is recommended that the adjustment setting position **1** is used for the main cleaning operations. The other adjustment settings are for ease of use, use on longer pile carpets, or for specialist cleaning tasks.

Settings

1. Best performance and energy efficiency, short to medium pile carpets, hard wooden floors, wooden floor boards with crevices, ceramic tiles.
2. Medium pile carpets, delicate floor coverings such as vinyl or linoleum, parquet flooring.
- 3 or 4. For longer pile carpets the motion resistance may increase. Use these intermediate settings to reduce the force required to push the vacuum cleaner.
5. Luxury carpet and Tool mode

IMPORTANT: Using this cleaner for loop pile carpets with pile greater than 30mm is not recommended. Please consult the floorcare/carpet manufacturer's recommended cleaning instruction before vacuuming.

IMPORTANT: When cleaning delicate hard floors such as vinyl or linoleum the selector switch must be moved to position **2**. Failure to do so may cause damage to the floor surface.

This vacuum cleaner is supplied with an Energy Label as required by European Regulation (EU) 665/2013. If the label shows a red prohibition circle on the right covering the hard floor symbol, then this indicates that the vacuum cleaner is not suitable for use on hard floors.

#1 NOTE: Dust pick up ability carpet, dust pick up ability hard floor, and energy efficiency in accord with Commission Regulations (EU) 665/2013 and (EU) 666/2013.

CLEANER RELEASE

Unlock the cleaner by pressing down on the left pedal with your foot.

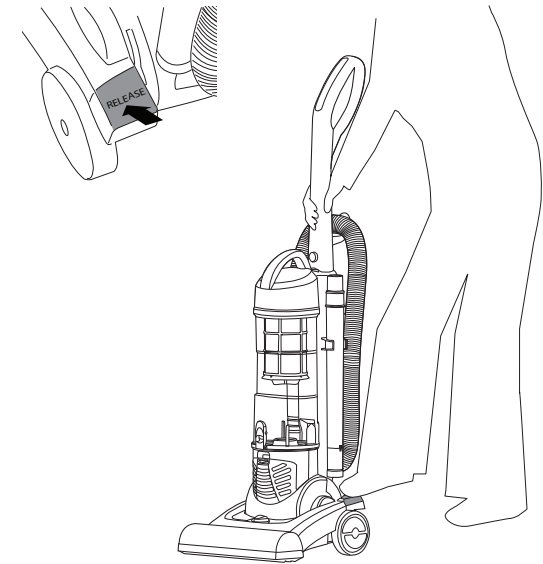

POWER SWITCH

To switch the cleaner on or off press down on the right pedal with your foot.

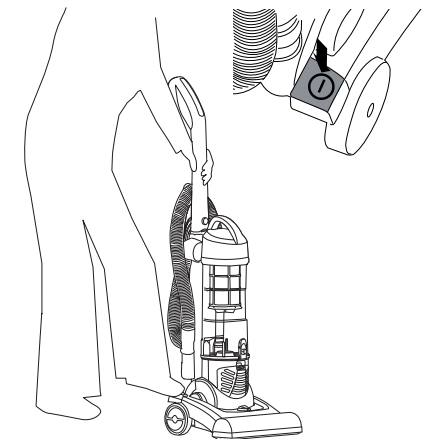

CLEANING TOOLS

Handle

All accessories can fit onto the end of the hose. Combine accessories depending on use.

Pet Hair & Allergen Remover*

The pet hair & allergen remover is ideal for removing pet hairs. DO NOT touch the rotating brush.

- 1 Remove the short stretch hose from the Hose socket. Plug in the longer stretch hose in the hose socket.

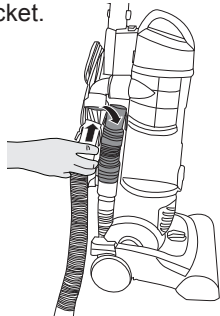

- 2 Pull out extension tube and long crevice tool.

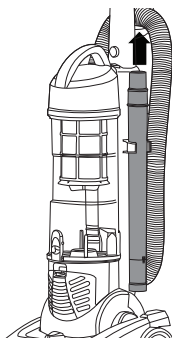

- 3 Remove the long crevice tool from the extension tube.

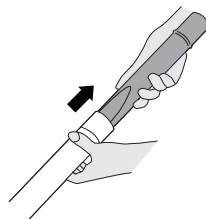

- 4 Fit the extension tube to the hose.

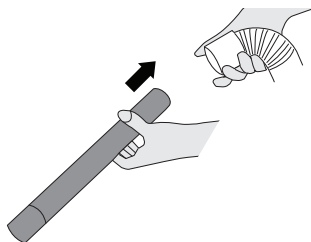

- 5 Attach the long crevice tool to the extension tube or directly to the hose.

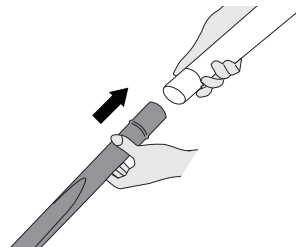

- 6 Fit the dusting brush or the Pet Hair and Allergen Remover* or parquet nozzle* to the hose or at the end of the extension tube.

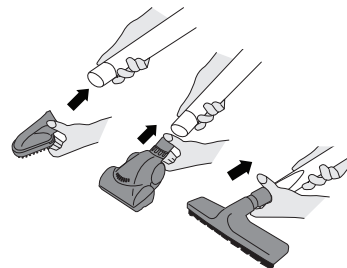

IMPORTANT! When using cleaning tools, the cleaner must be kept in the upright position, particularly when cleaning stairs. The nozzle height should also be set to tool mode.

CLEANING THE STAIRS

Both short and long stretch hoses are supplied with the cleaner. When the user needs to use the longer stretch hose, the short hose should be removed from the hose socket and replaced by the longer stretch hose.

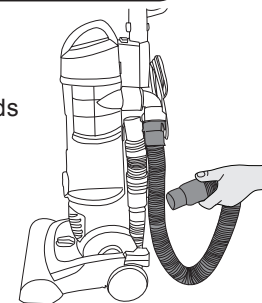

It is dangerous to place the cleaner above you when cleaning stairs.



ALWAYS work with the cleaner below you. Ensure it is positioned up against the bottom step.

STORING THE CLEANER

Turn the cleaner off and remove the plug. Wind the power cord around the cord storage hooks.

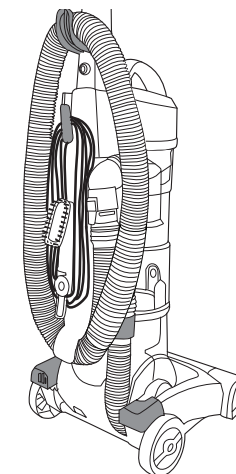

EMPTYING THE BIN

- 1 To remove the bin from the cleaner press the bin release button.

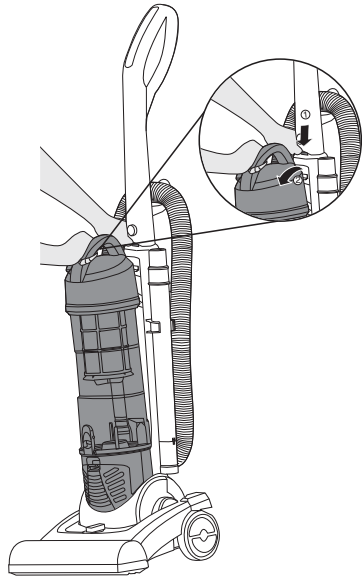

- 2 Hold the container over the Bin and press the easy open button at the rear of the container.

The bin door will open and you can empty into a bin with no dust contact.

- 3 Once emptied, gently tap or shake the container to release any excess dust from the filters.

Do not overfill the bin above the max level line.

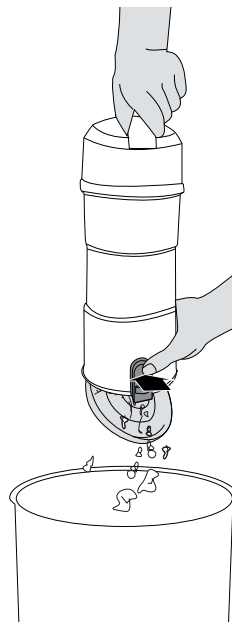

CLEANING THE PRE MOTOR FILTERS

- 1 Rotate the upper part of the dust bin to open.



- 3 Remove the mesh frame from the HEPA filter, then gently tap both filters to release any excess dust.

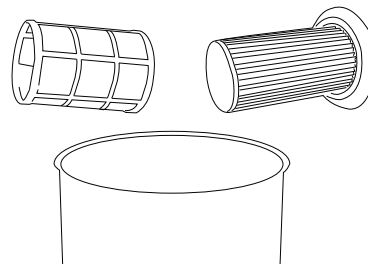

- 2 Remove the filter assembly from the bin top by rotating the filter. It is advisable to wash the filters after every 5 bin empties.

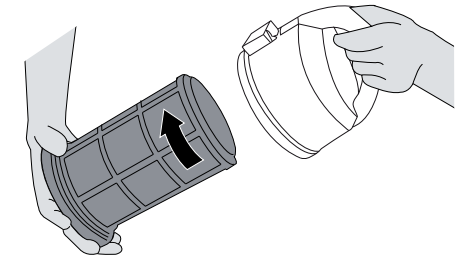

- 4 Wash both filter and protective mesh under warm water until the water runs clean. Remove excess water by shaking and leave to dry for 24 hours. Reassemble and refit filters to cleaner, only when they are completely dry.

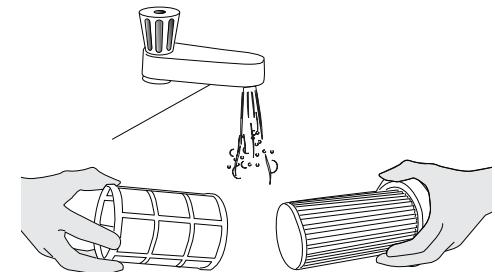

! **IMPORTANT!** Ensure the mesh frame is reassembled to the HEPA filter before use

CLEANING THE EXHAUST FILTER

The exhaust filter should be washed every month. Press down on the latch to remove the exhaust grille. Remove filter and wash with warm water.

Remove excess water by shaking and leave to dry for 24 hours. Refit filters only when completely dry.

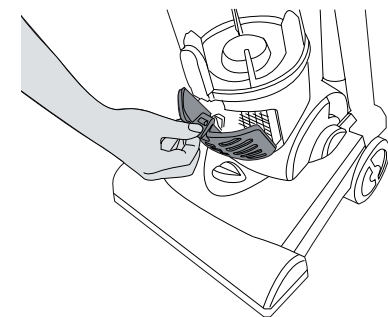

CHANGING THE BELT OR BRUSHES

If your cleaner is not picking up efficiently, the belt or brushes (or both) may need replacing, but first please make sure you have:

- Emptied the bin
- Cleaned the filters
- Checked for blockages

IMPORTANT: Switch the cleaner off and remove the plug from the electricity supply before attempting any maintenance.

- 1** Turn the cleaner over and remove 6 retaining screws attaching the brush guard to the base.

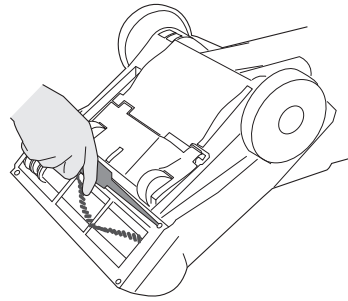

- 2** Remove the brush guard

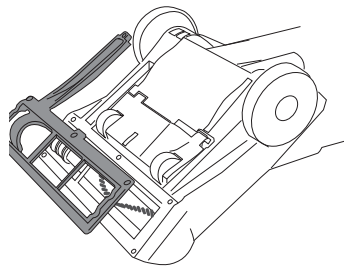

- 3** Remove brush assembly and check for wear on the belt.

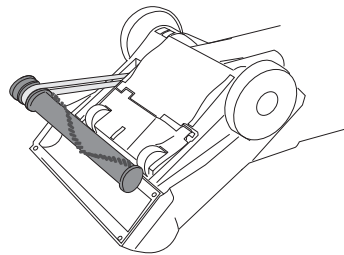

Loop the new belt around the motor and brush channel.

- 4** Hold the brush assembly and stretch the belt until the brush can be slotted back into the cleaner housing.

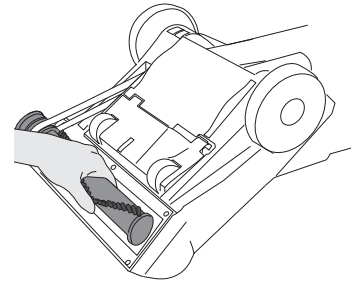

- 5** Rotate the brush to ensure free movement of the belt.

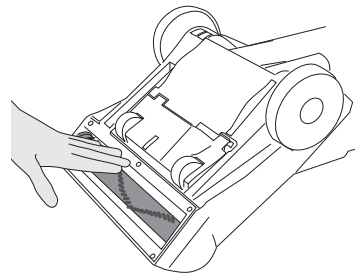

- 6** Refit the brush guard with 6 retaining screws.

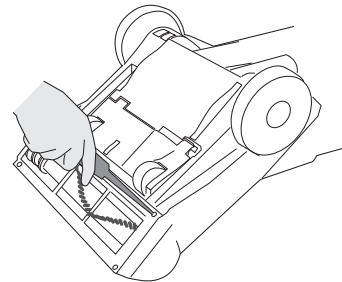

CLEARING A BLOCKAGE

IMPORTANT: Switch the cleaner off and remove the plug from the electricity supply before attempting any maintenance.

Check the cleaning tools and hose for blockages.

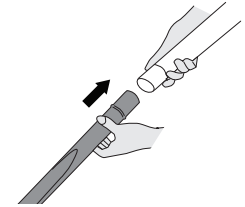

The hose can be removed at both ends.

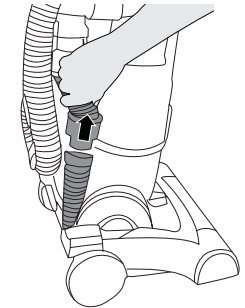

Turn the cleaner over and rotate the brushes to identify any obstructions including hair.

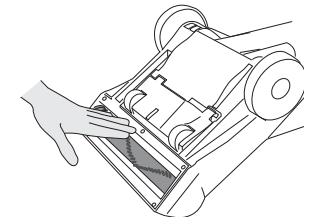

Check for a blockage in the hose socket. Use a flexible rod to remove any obstruction.

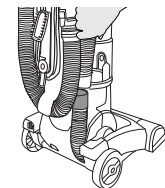

To clear a blockage in the Pet Hair & Allergen Remover*, twist the collar at the rear and lift the cover.

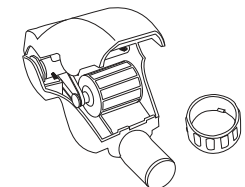

User checklist

If your cleaner is not working properly run through the following checklist.

1. Is there a working electricity supply to the cleaner?
Check with another electrical product.
2. Is the bin full or choked with fine dust?
To empty the bin, see instructions on P6.
3. Is the hose blocked?
To clear a blockage, see instructions on P7.
4. Is there a blockage in the cleaner base?
To clear a blockage, see the instruction on P7.
5. Are the filters blocked?
To clean filters, see the instruction on P6.
6. Is the nozzle height set correctly?
To set the carpet height selector, see the instruction on p4.
7. Are the brushes rotating correctly?
To check the brushes, see the instructions on p7.
8. Has the cleaner overheated?
If so, it will take about 30 minutes to reset.

If there is any doubt call the Hoover Service Office for advice. They may be able to assist you over the telephone. A service charge will be made if the cleaner is examined and found to be in working order, has not been assembled in accordance with these instructions or has been used incorrectly. working order, has not been assembled in accordance with these instructions or has been used incorrectly.

WARNING!

A thermal cut out switches off the cleaner to prevent overheating if it is used when full or there is a blockage or dirty filters. If this should happen switch off, unplug and correct the fault.

It will take about 45 minutes for the cut out to automatically reset.

IMPORTANT: Do not run cleaner over the supply cord as this could damage the supply cord insulation.

IMPORTANT INFORMATION

Hoover Service

Should you require service at any time, please contact your local Hoover Service Office.

Hoover spares and Consumables

Always replace parts with genuine Hoover spares. These are available from your local Hoover dealer or direct from Hoover. When ordering parts always quote your model number.

Quality

Hoover's factories have been independently assessed for quality. Our products are made using a quality system which meets the requirements of ISO 9001

GUARANTEE STATEMENT

The guarantee conditions for this appliance are as defined by our representative in the country in which it is sold. Details regarding these conditions can be obtained from the dealer from whom the appliance was purchased. The bill of sale or receipt must be produced when making any claim under the terms of this guarantee.

Subject to change without notice.



GENERATION FUTURE

Hoover Limited
Pentrebach
Merthyr Tydfil
Mid Glamorgan
CF48 4TU

HOOVER CUSTOMER HELPLINE
08444 995 599

© 2014 48011552