

HOOVER

PURE POWER



INSTRUCTION MANUAL



®

GENERATION FUTURE

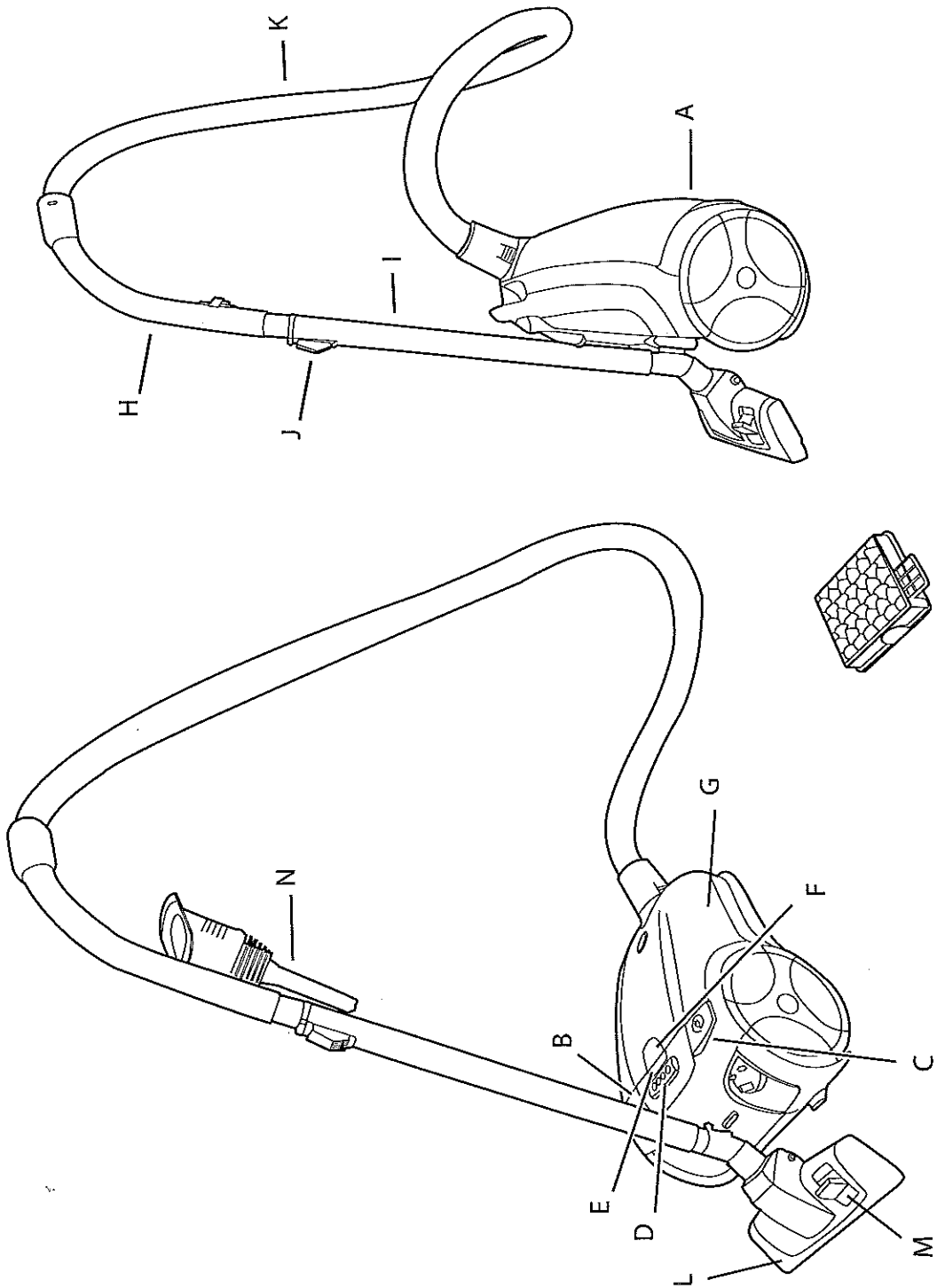
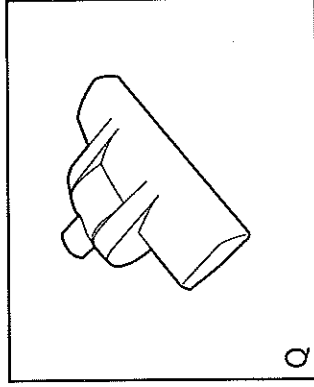
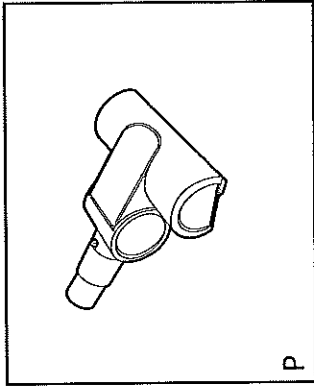
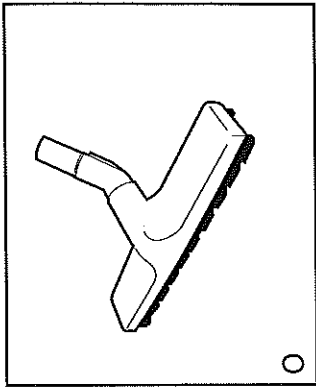

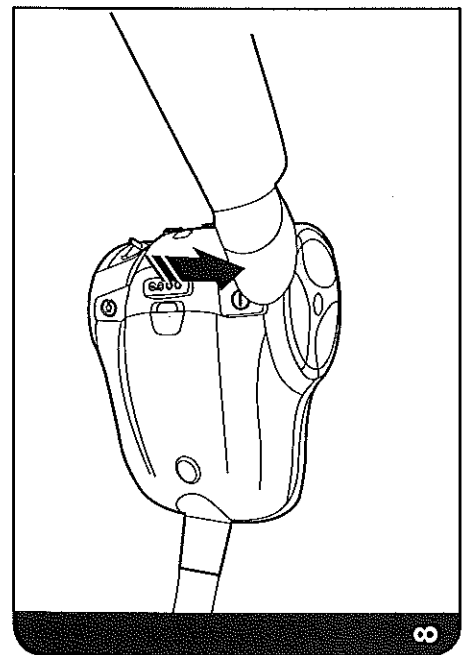
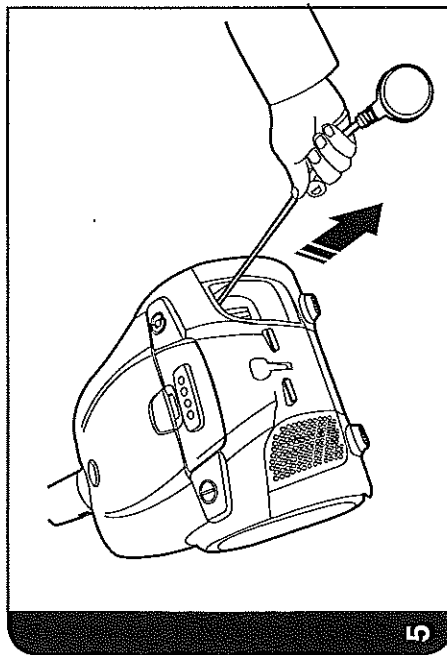
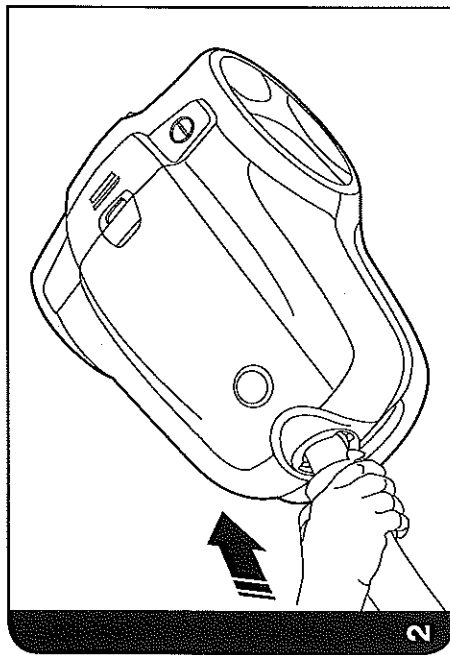
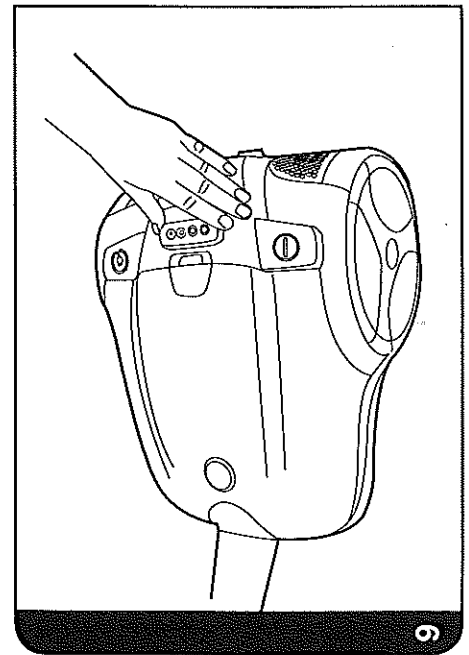
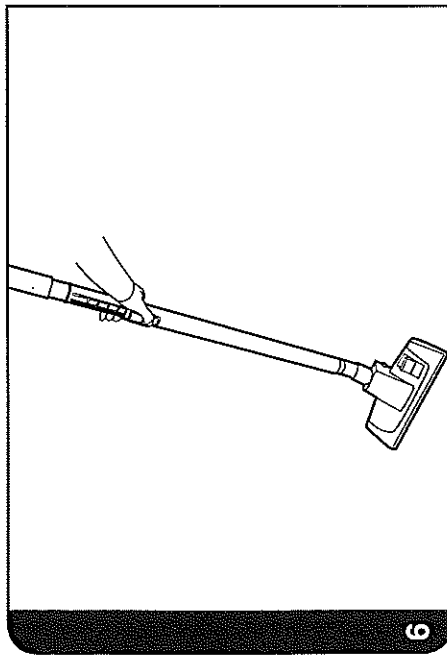
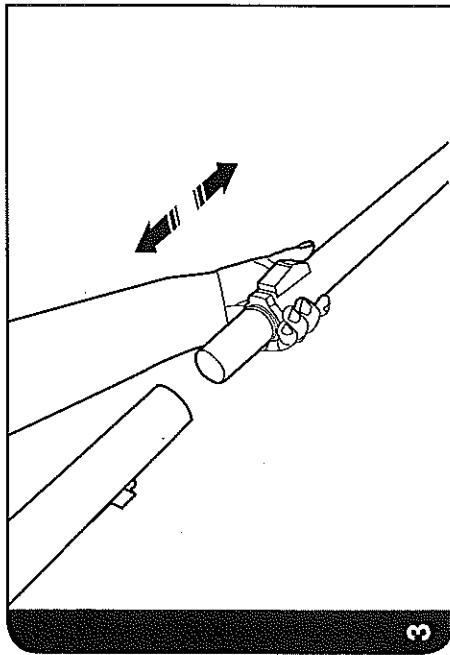
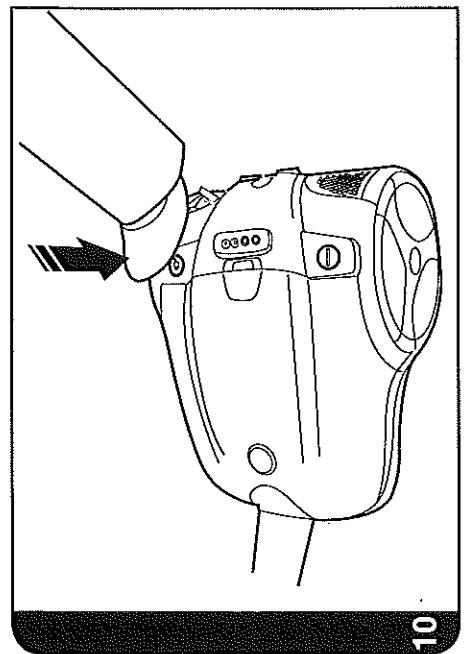
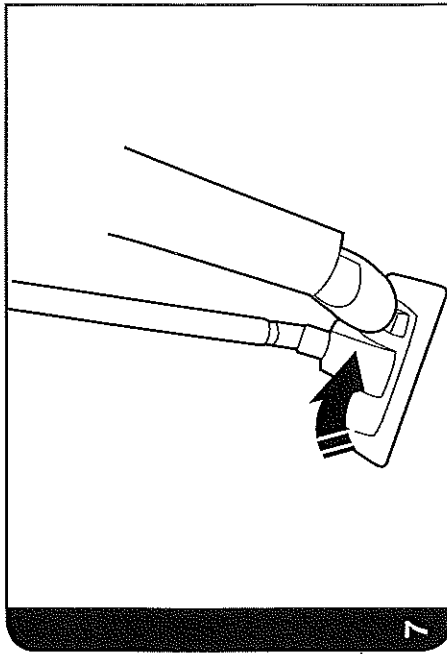
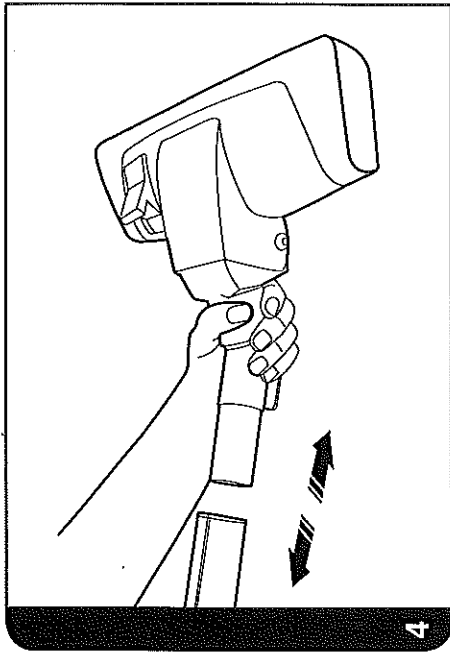

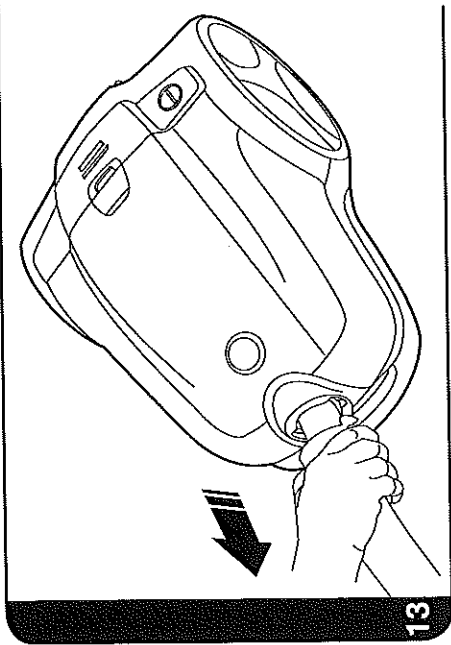

13

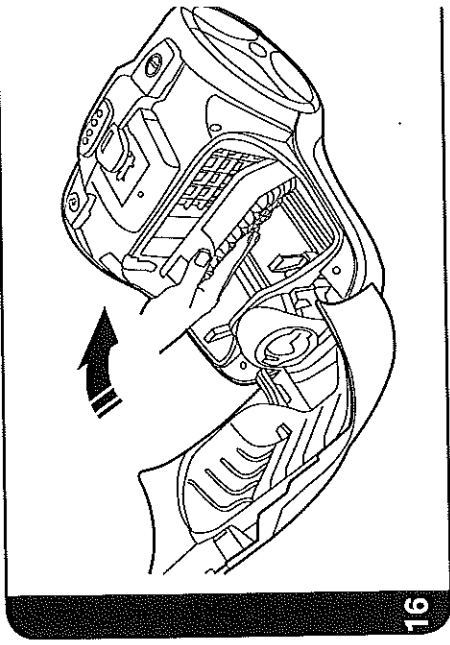

16

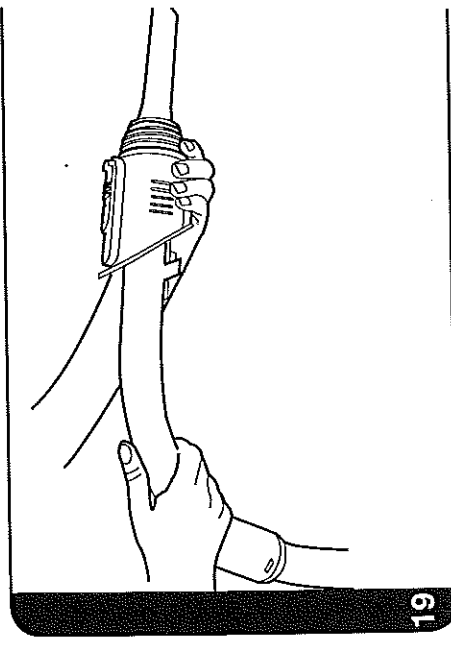

19

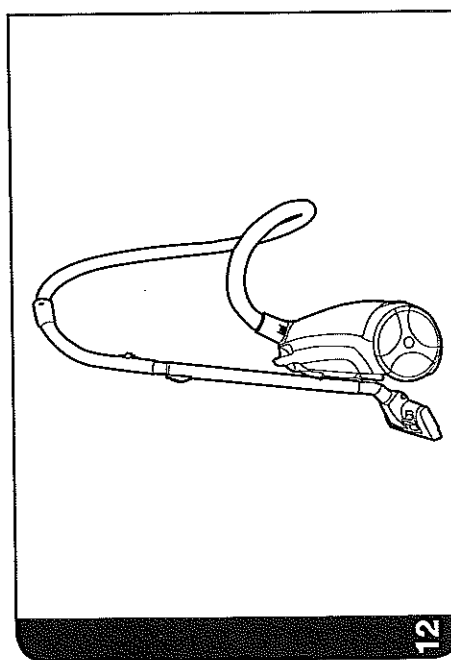

12

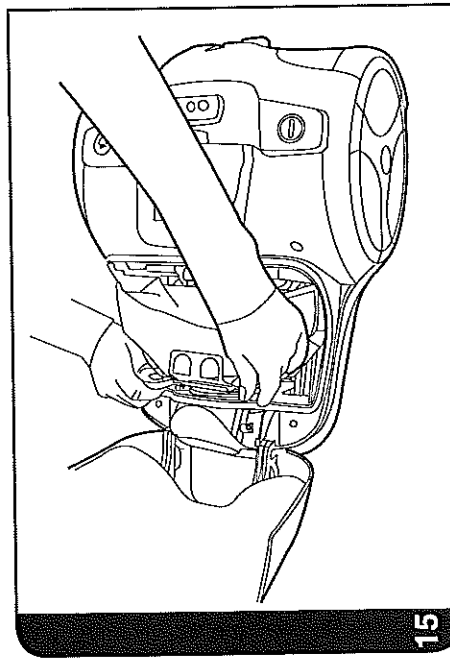

15

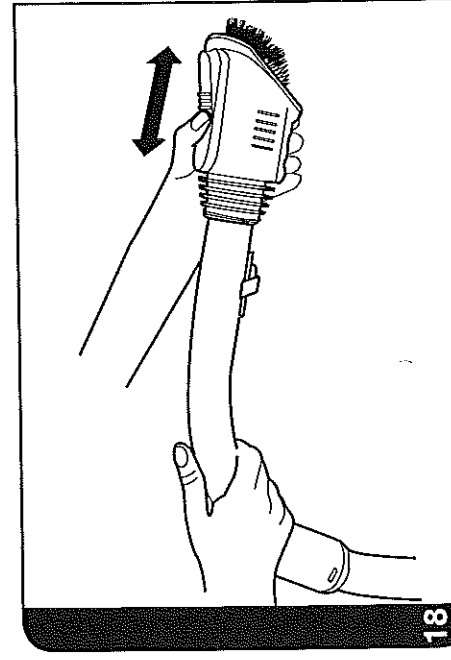

18

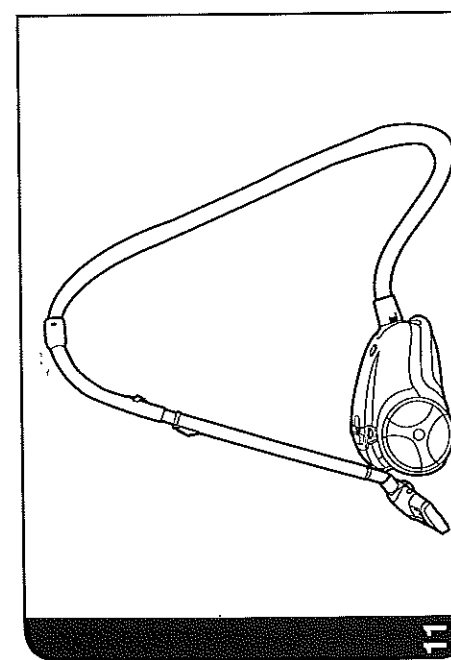

11

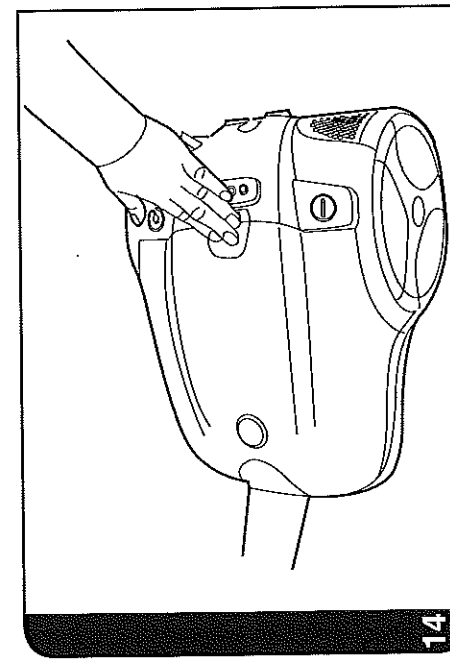

14

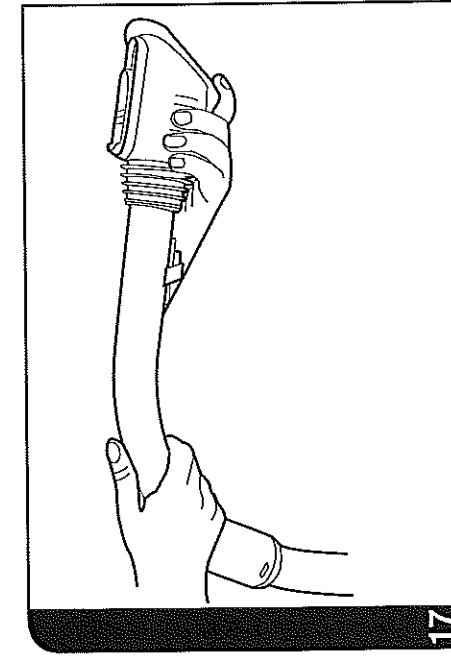

17

IMPORTANT SAFETY REMINDERS

This cleaner should only be used for domestic cleaning, as described in this user guide. Please ensure that this guide is fully understood before operating the appliance. Use only attachments recommended or supplied by Hoover.

WARNING: Electricity can be extremely dangerous. This appliance is double insulated and must not be earthed. This plug is fitted with a 13 amp fuse (UK only).

IMPORTANT: The wires in the mains power lead are coloured in accordance with the following code:

Blue – Neutral Brown – Live

STATIC ELECTRICITY: Some carpets can cause a small build up of static electricity. Any static discharge is not hazardous to health.

AFTER USE: Switch the cleaner off and remove the plug from the electricity supply. Always switch off and remove the plug before cleaning the appliance or attempting any maintenance task.

SAFETY WITH CHILDREN, ELDERLY OR THE INFIRM: Do not let children play with the appliance or its controls. Please supervise the use of the appliance by older children, the elderly or the infirm.

HOOVER SERVICE: To ensure the continued safe and efficient operation of this appliance we recommend that any servicing or repairs are only carried out by an authorised Hoover service engineer.

IT IS IMPORTANT THAT YOU DO NOT:

- Position the cleaner above you when cleaning the stairs.
- Use your cleaner out of doors or on any wet surface or for wet pick up.
- Pick up hard or sharp objects, matches, hot ashes, cigarette ends or other similar items.
- Spray with or pick up flammable liquids, cleaning fluids, aerosols or their vapours as this may cause risk of fire / explosion.
- Run over the supply cord when using your cleaner or remove the plug by pulling on the supply cord.
- Stand on or wrap the power cord around arms or legs when using the cleaner.
- Use the appliance to clean people or animals.
- Continue to use your cleaner if it appears to be faulty. If the supply cord is damaged stop using the cleaner IMMEDIATELY. To avoid a safety hazard, an authorised Hoover service engineer must replace the supply cord.

GETTING TO KNOW YOUR CLEANER

- Main Cleaner
- On/Off Button
- Cord Rewind Button
- Suction Control
- Bag Check Indicator
- Bag Door Release Button
- Bag Door
- Handle
- Telescopic Tube
- Telescopic Tube Release
- Hose
- Carpet and Floor nozzle
- Carpet Care Control Selector
- 3 in 1 Tool
- Parquet Caresse Nozzle
- Pet Hair Remover Mini Turbo Brush
- Allergen Remover Turbo Brush

ASSEMBLING YOUR CLEANER

Remove all components from the packaging.

1. Connect the hose to the cleaner main body, ensuring it clips and locks into position. To release: simply press the two buttons on the hose end and pull [2].
2. Connect the tube upper end to the navigator handle, and store the 3in 1 tool underneath the handle [3].
3. Connect the tube lower end to the carpet and floor nozzle [4].

USING YOUR CLEANER

1. Extract power cord and plug it into the power supply. Do not pull the cord beyond the red marker [5].
2. Adjust the length of the telescopic tube by moving the telescopic release button up and raise or lower the handle to the most comfortable cleaning position [6].
3. Carpet & Floor Nozzle. Press the pedal on the nozzle [7] to select the ideal cleaning mode for the floor type.
 - Hard Floor:** The brushes are lowered to protect the floor
 - Carpet:** With lifted brushes for the deepest clean
4. Switch the cleaner on by pressing the On/Off Button on the cleaner main body [8].
5. Adjust the suction by sliding the suction regulator to the desired level. (certain models only) [9].
6. Switch off at the end of use by pressing the On/Off Button. Unplug and press the cord rewind button to wind the power cord back into the cleaner [10].
7. Parking and Storage - The tube can be parked for temporary storage while in use [11], or in the storage position when not in use [12].

CLEANER MAINTENANCE

Replacing The Dust Bag

If the bag check indicator is red please check and, if necessary, replace the bag. [13]

1. Remove the hose from the main cleaner.
2. Press the button [14] to open the cover and pull the bag collar to remove the bag. The full dust bag should be disposed of correctly and carefully.
3. Fold a new bag as shown on the bag and fit by inserting the collar into the bag holder [15].
4. Close the cover.

Remember: The bag check indicator may also flash if an obstruction has occurred. In this case refer to 'Removing A Blockage From the System'.

Cleaning the Filter

Hepa filter

To maintain optimum performance of your cleaner, please wash the Pre-Motor filter after each 5 bag changes.

To remove the Pre-Motor filter press the latch at the top of the Hepa pre-motor filter frame to unlock it from the cleaner. Tilt then remove the filter from the cleaner. Wash it in hand warm water, and allow it to dry thoroughly before replacing to the cleaner [16].

Remember: Do not use hot water or detergents. In the unlikely event of the filters becoming damaged, fit a Genuine Hoover replacement. Do not try and use the product without a dust bag or filter fitted.

Removing a Blockage From The System

If the bag check indicator is illuminated or flashing:

1. Check if the bag is full. If so refer to 'Replacing The Dust Bag'.
 - A. Do the filters need cleaning? If so refer to 'Cleaning the Filter'.
 - B. Check if there is any other blockage in the system - Use a rod or a pole to remove any blockage from the Teletube or flexible hose.

Warning - The bag check indicator will turn red if the cleaner is used when full, if there is a blockage or if the filters are dirty. If the cleaner is used for a significant period of time with the bag check indicator is red, a thermal cut out will switch the cleaner off to prevent overheating. The bag check indicator turn green once the cleaner has switched off to signal that the thermal cut out has been activated. If this should happen, switch the cleaner off, unplug and correct the fault. It will take about 30 minutes for the cut out to automatically reset.

ACCESSORIES

Please see the model specification on the packaging label for inclusion of accessories to individual models. All accessories can be purchased separately from Hoover. (See Hoover Spares and Consumable section).

All accessories can be fitted to the end of the hose or the end of the telescopic tube.

3 in 1 tool – Combines several functions in one, the 3 in 1 tool can be connected as a furniture nozzle [17]. By adjusting the slider the tool becomes a dusting brush [18]. Alternatively the 3 in 1 tool can be connected as a crevice tool [19]. The 3 in 1 tool can be stored neatly underneath the hose handle.

Crevice Tool – For corners and hard to reach areas.

Furniture Nozzle – For soft furniture and fabrics.

Dusting Brush – For bookshelves, frames, keyboards and other delicate areas. To extend the brushes push the button on the body of the tool.

Parquet Caresse Nozzle* – For parquet floors and other delicate floors [10].

Pet Hair Remover Mini Turbo Brush* – Use the mini turbo nozzle on stairs or for deep cleaning on textile surfaces and other hard to clean areas [1P].

Allergen Remover Turbo Brush* – Use the turbo nozzle for deep cleaning on carpets. [1Q]

IMPORTANT: Do not use the mini turbo nozzles on rugs with long fringes, animal hides and carpet pile deeper than 15mm. Do not keep the nozzle stationary while the brush is rotating.

USER CHECKLIST

Should you have a problem with the product, complete this simple user checklist before calling your local Hoover service.

- Is there a working electricity supply to the cleaner? Please check with another electrical appliance
- Is the dust bag over-filled? Please refer to 'Cleaner Maintenance'
- Is the Filter blocked? Please refer to 'Cleaning the filter'
- Is the hose or nozzle blocked? Please refer to 'Removing a blockage from the system'
- Has the cleaner overheated? If so, it will take approximately 30 minutes to automatically reset

IMPORTANT INFORMATION

Hoover spares and Consumables

Always replace parts with genuine Hoover spares. These are available from your local Hoover dealer or direct from Hoover. When ordering parts always quote your model number.

- PUREHEPA ANTI-ODOUR BAG: H60, 35600392
- HEPA PRE-MOTOR FILTER: S81, 35600520
- CARPET & FLOOR NOZZLE: G98, 35600878
- PARQUET CARESSE NOZZLE : G90 PC, 35600660
- TURBO NOZZLE: J31, 35600816
- MINI TURBO NOZZLE: J32, 35600817
- COMPLETE FLEXIBLE HOSE: D106, 35600881
- ALLERGY DEFENDER GRANULES: A31G, 35600451

Hoover Service

Should you require service at any time, please contact your local Hoover Service Office.

Quality, Safety and the Environment

Safety

Although safety certification of electrical appliances is not required by law in the UK, Hoover believe that independent approval is the best way of demonstrating safety in design and manufacture. The British Electrotechnical Approvals Board (BEAB), the independent UK national authority for the safety of domestic electrical appliances, ensures that European safety standards are met and maintained throughout the production life of an appliance. All appliances that pass the requirements are permitted to carry the BEAB mark of safety.

Quality

BSI ISO 9001

Hoover's factories have been independently assessed for quality. Our products are made using a quality system which meets the requirements of ISO 9001.

The Environment:

This appliance is marked according to the European Directive 2002/96/EC on Waste Electrical and Electronic Equipment (WEEE).

By ensuring this product is disposed of correctly you will help prevent potential negative consequences for the environment and human health, which could otherwise be caused by inappropriate waste handling of this product.

The symbol on the product indicates that this product may not be treated as household waste. Instead it shall be handed over to the appliance collection point for recycling of electrical and electronic equipment.

Disposal must be carried out in accordance with the local environmental regulations for waste disposal.

For more detailed information about treatment, recovery and recycling of this product, please contact your local city office, your household waste disposal service or the shop where you purchased the product.

Your Guarantee

The guarantee conditions for this appliance are as defined by our representative in the country in which it is sold. Details regarding these conditions can be obtained from the dealer from whom the appliance was purchased. The bill of sale or receipt must be produced when making any claim under the terms of this guarantee.

Subject to change without notice.



®
GENERATION FUTURE

PRINTED IN P.R.C.
0565 5337