

Instruction Book

Condenser Tumble Dryer

VisionHD

Sensor Dry

8kg

English



Contents

Introduction	3
Delivery information	3
Unpacking the product	3
Safety reminders	4
Installation	4
Use	4
The Laundry	4
Environmental Issues	5
GIAS Service	5
Installation	6
Electrical requirements	6
Adjusting the feet	6
Ventilation	7
Preparing the load	8
Clothes preparation	8
Sorting the load	9
Drying advice	10
Do not tumble dry	10
Energy saving	10
Controls and indicators	11
Selecting the Programme	12
Door and Filter	14
Opening the door	14
Filter	14
Filter care indicator	14
Water container	15
To remove the container	15
Condenser	16
To remove the condenser	16
Operation	17
Cancelling and resetting the programme	18
Cleaning and Routine Maintenance	18
Cleaning the dryer	18
Technical specifications	18
Troubleshooting	19
Customer Service	20
Hoover Spares	20
GIAS Service	20
Your Guarantee	21
Hoovercare	22

Introduction



Please read and follow these instructions carefully and operate the machine accordingly. This booklet provides important guidelines for safe use, installation, maintenance and some useful advice for best results when using your machine.

Keep all documentation in a safe place for future reference or for any future owners

Delivery information

Please check that the following items are delivered with the appliance:

- Instruction manual
- Guarantee card
- Energy label

Unpacking the Product

1. Cut carefully around the base of the packaging and up one corner.
2. Remove the polythene sleeve and lift the dryer off the polystyrene base.

If the appliance is not running properly or breaks down, switch it off, disconnect the plug from the socket and do not tamper with the appliance. Consult GIAS Service for possible repair.

**Call
08444
995599**

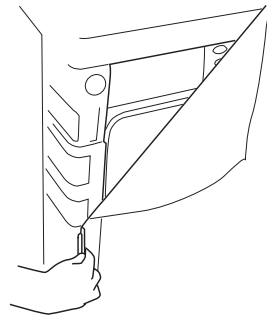

Check that no damage has occurred to the machine during transit. If it has, call for service by GIAS.

Call 08444 995599

Dispose of the packaging safely. Make sure it is out of the reach of children, it is a potential source of danger.

Failure to comply with the above can compromise the safety of the appliance. You may be charged for a service call if a problem with your machine is caused by misuse.

Safety reminders

Installation

- Check that the product has no visible signs of damage before use. If damaged do not use and please call GIAS Service.
- Do not use adapters, multiple connectors and/or extensions.
- Never install the dryer against curtains and be sure to prevent items from falling or collecting behind the dryer.
- The appliance must not be installed behind a lockable door, a sliding door or a door with a hinge on the opposite side to that of the tumble dryer.

Use

- This appliance is not intended for use by persons (including children) with reduced physical, sensory or mental capabilities, or lack of experience and knowledge, unless they have been given supervision or instruction concerning use of the appliance by a person responsible for their safety.
- Children should be supervised to ensure that they do not play with the appliance.
- **WARNING** Misuse of a tumble dryer may create a fire hazard.
- This machine is solely for domestic use, i.e. to dry household textiles and garments.
- This machine should only be used for its intended purpose as described in this manual. Ensure that the instructions for installation and use are fully understood before operating the appliance.
- Do not touch the appliance when hands or feet are damp or wet.
- Do not lean on the door when loading the machine or use the door to lift or move the machine.
- Do not allow children to play with the machine or its controls.
- **WARNING** Do not use the product if the fluff filter is not in position or is damaged; fluff could be ignited.
- **WARNING** Where the hot surface symbol  is located the temperature rise during operation of the tumble dryer may be in excess of 60 degrees C.
- Remove the plug from the electricity supply. Always remove the plug before cleaning the appliance.
- Do not continue to use this machine if it appears to be faulty.
- Lint and fluff must not be allowed to collect on the floor around the outside of the machine.
- The drum inside may be very hot. Always allow the dryer to complete the cool down period before removing the laundry.

The Laundry

- Do not dry unwashed items in the tumble dryer.
- **WARNING** Do not tumble dry fabrics treated with dry cleaning fluids.
- **WARNING** Foam rubber materials can, under certain circumstances, when heated become ignited by spontaneous combustion. Items such as foam rubber (latex foam), shower caps, waterproof textiles, rubber backed articles and clothes or pillows fitted with foam rubber pads **MUST NOT** be dried in the tumble dryer.
- Always refer to the laundry care labels for directions on suitability for drying.

- Clothes should be spin dried or thoroughly wrung before they are put into the tumble dryer. Clothes that are dripping wet should **NOT** be put into the dryer.
- Lighters and matches must not be left in pockets and **NEVER** use flammable liquids near the machine.
- Glass fibre curtains should **NEVER** be put in this machine. Skin irritation may occur if other garments are contaminated with the glass fibres.
- Items that have been soiled with substances such as cooking oil, acetone, alcohol, petrol, kerosene, spot removers, turpentine, waxes and wax removers should be washed in hot water with an extra amount of detergent before being dried in the tumble dryer.
- Fabric softeners, or similar products, should be used as specified by the fabric softener instructions.

Environmental Issues

- All packaging materials used are environmentally-friendly and recyclable. Please help dispose of the packaging via environmentally-friendly means. Your local council will be able to give you details of current means of disposal.
- To ensure safety when disposing of an old tumble dryer disconnect the mains plug from the socket, cut the mains power cable and destroy this together with the plug. To prevent children shutting themselves in the machine break the door hinges or the door lock.

GIAS Service

- To ensure the continued safe and efficient operation of this appliance we recommend that any servicing or repairs are only carried out by an authorised GIAS service engineer.

European directive 2002/96/EC

This appliance is marked according to the European directive 2002/96/EC on Waste Electrical and Electronic Equipment (WEEE).

By ensuring this product is disposed of correctly, you will help prevent potential negative consequences for the environment and human health, which could otherwise be caused by inappropriate waste handling of this product.

The symbol on the product indicates that this product may not be treated as household waste. Instead it shall be handed over to the applicable collection point for the recycling of electrical and electronic equipment.

Disposal must be carried out in accordance with local environmental regulations for waste disposal.

For more detailed information about treatment, recovery and recycling of this product, please contact your local city office, your household waste disposal service or the shop where you purchased the product.



Installation

You may be charged for a service call if a problem with your machine is caused by incorrect installation.

If the mains cord on this appliance is damaged, it must be replaced by a special cord which is ONLY obtainable from the GIAS spares service. It must be installed by a competent person.

**Call
08443
712758**

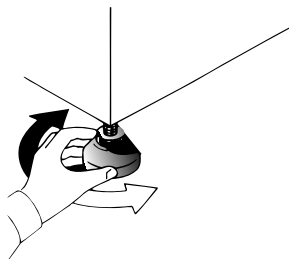

Electrical requirements

Tumble dryers are supplied to operate at a voltage of 230-240V, 50 Hz single phase. Check that the supply circuit is rated to at least 13A.

This appliance is fitted with a moulded-on non-rewireable plug which is already equipped with a BS 1362 ASTA approved 13A fuse. Any replacement must be the same rating and specification. **If the fuse cover is lost, do not use the plug until it is replaced.**

Electricity can be extremely dangerous.

This appliance must be earthed.

The socket outlet and the plug on the appliance must be of the same type.

Do not use multiple adapters and/or extension leads.

The plug should be accessible for disconnection after the appliance has been installed.

The wires in the mains lead are coloured in accordance with the following codes:

Blue	NEUTRAL
Brown	LIVE
Green and Yellow	EARTH

CE Appliance complies with European Directive 89/336/EEC, 73/23/EEC and subsequent amendments.

Do not plug the machine in and switch it on at the mains until the installation is completed.

Adjusting the feet

Once the machine is in place the feet should be adjusted to ensure that the machine is level.

Ventilation

Adequate ventilation must be provided in the room where the tumble dryer is located to prevent gases from appliances burning other fuels, including open fires, being drawn into the room during operation of the tumble dryer.

- Exhaust air must not be discharged into a flue which is used for exhausting fumes from appliances burning gas or other fuels.
- Check regularly that the air flowing through the dryer is not restricted.
- Check the fluff filter after use, and clean, if necessary.
- The inlet and outlets should be kept free from obstructions. To ensure adequate ventilation the space between the bottom of the machine and the floor must not be obstructed. There should be a gap of at least 12mm between the machine and any obstructions.
- Prevent items from falling or collecting behind the dryer as these may obstruct the air inlet and outlet.
- **NEVER** install the dryer up against curtains.

**For your safety,
this dryer must
be correctly
installed.**

**If there is any
doubt about
installation, call
the national GIAS
Service number
for advice.**

**08444
995599
(Eire 0818
200021)**

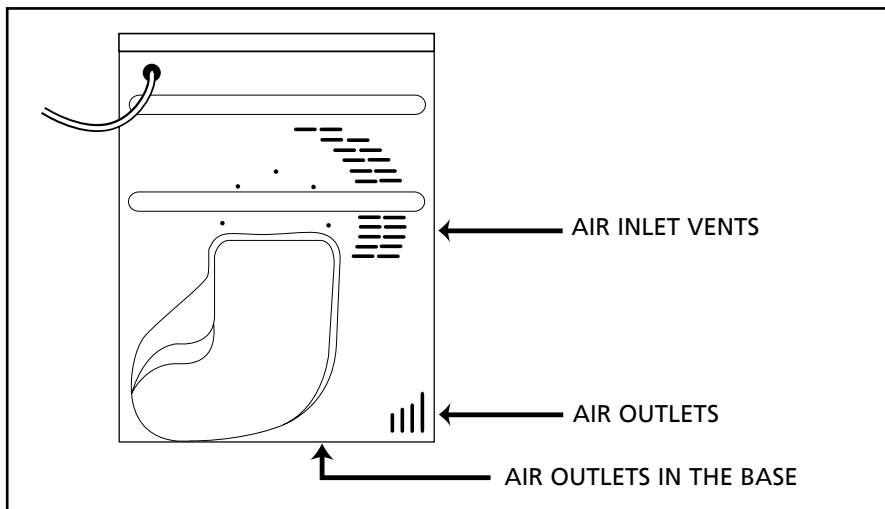

Preparing the load

Before using the tumble dryer for the first time:

- Please read this instruction book thoroughly.
- Remove all items packed inside drum.
- Wipe the inside of the drum and door with a damp cloth to remove any dust which may have settled in transit.

Clothes preparation

Make sure that the laundry you are going to dry is suitable for drying in a tumble dryer, as shown by the care symbols on each item.





Check that all fastenings are closed and that pockets are empty. Turn the articles inside out. Place clothes loosely in the drum to make sure that they don't get tangled.

Do not overload the drum, large items when wet can exceed the maximum admissible clothes load (for example: sleeping bags, duvets).

Maximum drying weight

- Cottons Max. 8 kg
- Synthetics Max. 4 kg

Sort the load as follows:

- **By care symbols**
These can be found on the collar or inside seam:
 -  Suitable for tumble drying.
 -  Tumble drying at high temperature.
 -  Tumble drying at low temperature only.
 -  Do not tumble dry.

If the item does not have a care label it must be assumed that it is not suitable for tumble drying.
- **By amount and thickness**
Whenever the load is bigger than the dryer capacity, separate clothes according to thickness (e.g. towels from thin underwear).
- **By type of fabric**

Cottons/linen: Towels, cotton jersey, bed and table linen.

Synthetics: Blouses, shirts, overalls, etc. made of polyester or polyamid, as well as for cotton/synthetic mixes.
- **By drying level**
Sort into: iron dry, cupboard dry, etc. For delicate articles press the Delicates button to select low drying temperature.

Drying advice

IMPORTANT: Do not dry articles which have been treated with a dry cleaning fluid or rubber clothes (danger of fire or explosion).

During the last 15 minutes the load is always tumbled in cool air.

Do not tumble dry:

Woollens, silk, delicate fabrics, nylon stockings, delicate embroidery, fabrics with metallic decorations, garments with PVC or leather trimmings, training shoes, bulky items such as sleeping bags, etc.

Energy saving

Only put into the tumble dryer laundry which has been thoroughly wrung or spin-dried. The drier the laundry the shorter the drying time thus saving electricity.

ALWAYS

- Try to dry the maximum weight of laundry, this will save time and electricity.
- Check that the filter is clean before every drying cycle.

NEVER

- Exceed the maximum weight, this will waste time and electricity.
- Put dripping wet items into the tumble dryer, this may damage the appliance.

Controls and indicators

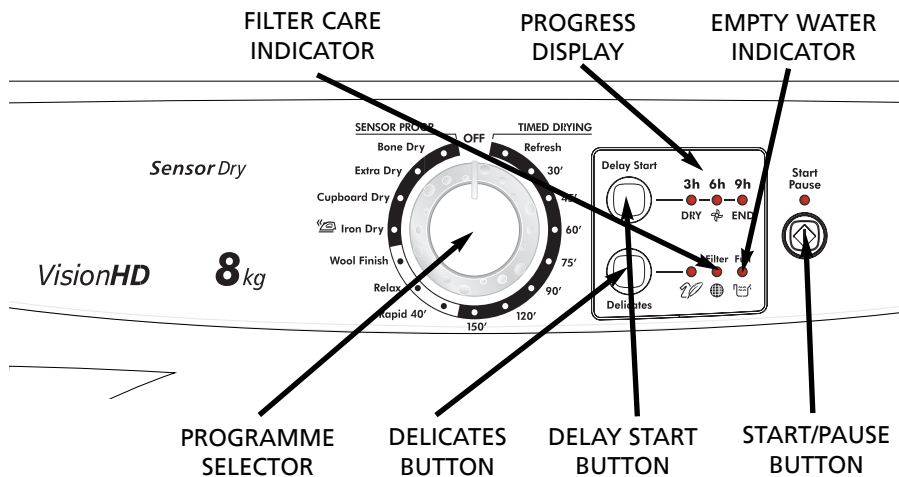

Control panel and indicator lights

Programme Selector – Select the required programme

Delay Start button – Allows the user to delay the start of the drying cycle (see details of Operation on page 17)

Start/Pause button – Press Start/Pause to commence the selected drying programme

Delicates button  – Press to reduce the heat level for delicate items, the indicator above the button will light up. To change the heat setting the programme must be reset

Low Heat – Indicator light **ON**

High Heat – Indicator light **OFF**

Empty Water indicator  – lights when the water container is full

Filter Care indicator  – lights when the filter needs cleaning

Progress display

DRY – When the programme is selected the DRY indicator will flash, when the programme starts the DRY indicator will light up.

 – Indicator lights when there is a short time left until completion of the programme. At this stage of the drying cycle the machine enters the Cool Down phase.

The length of the Cool Down phase varies between 10 and 15 minutes depending on the programme.

END – Indicator lights when the programme is finished.

Selecting a Programme

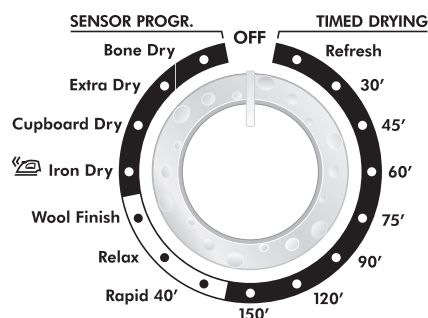

The Hoover Sensor Dry machine gives many options for drying the laundry to suit all circumstances.

The table on the next page lists the programmes and the function of each programme.

Note: The sensor may not detect a small load of small articles. For small loads and separate items or pre-dried fabrics with low moisture content, use the timed programmes. Set the programme between 30 and 75 minutes depending on the load size and dryness required, and select high or low heat depending upon the fabric type.

If the sensor does not detect the item the dryer will only operate for 10 minutes before going into cooldown.

If the load is too large or too wet to tumble dry the dryer will automatically go into cooldown after approximately 3 hours.

Programme	Description
Bone Dry	Select the degree of dryness that you require.
Extra Dry	This ranges from Bone Dry for bath towels and bathrobes, through Cupboard Dry for items that will be put away without ironing, to the programme that leaves the laundry suitable for ironing.
Cupboard Dry	
Iron Dry 	
Wool Finish	A gentle programme specially created to get woollens softer after air-drying. This delicate warm air cycle, lasting 12 minutes, can also be used to get woollens 'refreshed' after being stored in the wardrobe.
Relax	The Relax programme provides a conditioning and anticrease function. The dryer will heat the load for 9 minutes followed by a 3 minute cool down period and is especially good for garments which may have been left for some time prior to ironing, in a linen basket for example. Garments may also become stiffened when dried outside on a washing line or inside on radiators. This programme relaxes the creases in the fabric making ironing quicker and easier.
Rapid	The rapid programme allows a drying cycle to be completed quickly. This is an ideal programme for having dry, refreshed and ready-to-wear clothes in less than 40'. This special programme constantly monitors the dryness and temperature in the drum thanks to the sensor using, using the exact time and energy you need! The machine finishes the cycle when the cupboard dry level is reached. The stated cycle length could vary according to fabric types, load size and residual moisture in the garments. The maximum load is 2kg and the programme is suitable for all types of fabric where tumble drying is appropriate.
150'	150 minutes of drying
120'	120 minutes of drying
90'	90 minutes of drying
75'	75 minutes of drying
60'	60 minutes of drying
45'	45 minutes of drying
30'	30 minutes of drying
Refresh	Tumbling the laundry in cool air for 20 minutes

Door and Filter

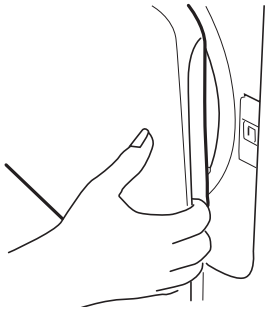

Opening the door

Pull on handle to open the door.

To restart the dryer, close the door and press the Start/Pause button.

WARNING!

When the tumble dryer is in use the drum and door may be **VERY HOT**. Never stop a tumble dryer before the end of the drying cycle unless all items are quickly removed and spread out so that the heat is dissipated.

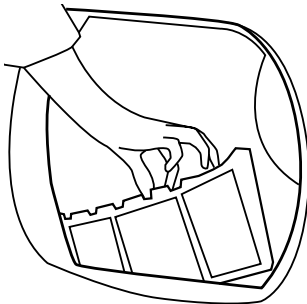

Filter

IMPORTANT: To maintain the efficiency of the dryer check that the fluff filter is clean before each drying cycle.

1. Pull the filter upwards.
2. Open filter as shown.
3. Gently remove lint using a soft brush or your fingertips.
4. Snap the filter together and push back into place.

DO NOT USE WATER TO CLEAN THE FILTER

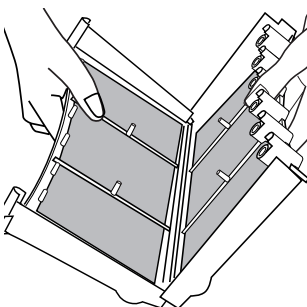

Filter Care Indicator

 lights when the filter needs cleaning.

If the laundry is not drying check that the filter is not clogged.

Water Container

The water removed from the laundry during the drying cycle is collected in a container at the bottom of the dryer.

When the container is full the 'Full' indicator on the control panel will light, and the container **MUST** be emptied. However, we recommend that the container is emptied after each drying cycle.

NOTE: Very little water will collect during the first few cycles of a new machine as an internal reservoir is filled first.

To remove the container

1. Gently pull the bottom of the kickplate so that it unclips from the dryer. The top section can then be unhinged allowing the kickplate to be completely removed.
2. Pull firmly on the handgrip and slide the water container out of the dryer.

Support the container with both hands. When full, the water container will weigh about 4kg.

3. Open the lid located on the top of the container and empty the water.
4. Refit the lid and slide the water container back into position. **PUSH FIRMLY INTO PLACE.**
5. Refit the kickplate by engaging the hinges at the top and 'snapping' the lower clips into place.

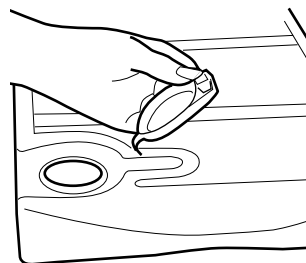
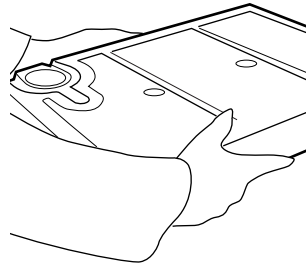
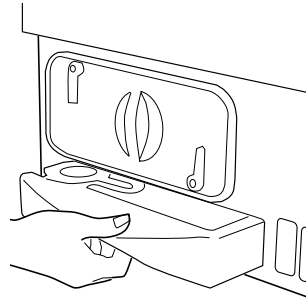
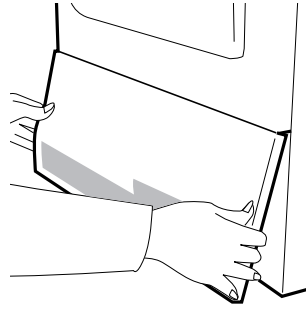

Condenser

Important: Always switch off and remove the plug from the electricity supply before cleaning the condenser.

To maintain the efficiency of the dryer regularly check that the condenser is clean.

To remove the condenser

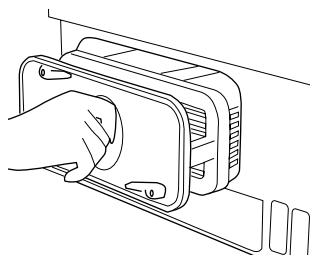

1. Remove the kickplate (see page 15).
2. Turn the two locking levers anti-clockwise and pull out the condenser.
3. Pull out the condenser unit.

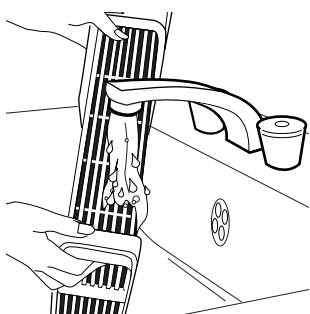

4. Gently remove any dust or fluff with a cloth, then wash the unit by holding it under a running tap turning it so that water flows between the plates, to remove any dust or fluff.
5. Refit the condenser ensuring it is in the correct way (as indicated by the arrow) and pushed firmly into place. Lock the two levers by turning them clockwise.
6. Refit the kickplate.

Operation

1. Open the door and load the drum with laundry. Ensure that garments do not hinder closure of the door.
2. Gently close the door pushing it slowly until you hear the door 'click' shut.
3. Turn the Programme Selector dial to select the required drying programme (see Programme Guide).
4. If drying synthetics, acrylics or delicate items, press the Delicates button to reduce the heat level.
The light next to the push button will light up when the machine is in low heat setting. To deselect in the first few minutes of the programme, press the Delicates button, after this time reset the machine to change the setting.
5. Press the Start/Pause button. The dryer will start automatically and the DRY indicator will be continuously lit.
6. If the door is opened during the programme to check the laundry, it is necessary to press Start/Pause to recommence drying after the door has been closed.
7. When the cycle is nearing completion the machine will enter the cool down phase, the clothes will be tumbled in cool air allowing the load to cool down.
8. When the programme is complete the END indicator will light.
9. Following the completion of the cycle the drum will rotate intermittently to minimize creasing. This will continue until the machine is switched OFF or the door is opened.

WARNING!
**The drum, door
and load may be
very hot.**

labelling and resetting the programme

To cancel a programme press the Start/Pause button for 3 seconds. The DRY light will flash to indicate that it has been reset.

Start Delay

The Delay Start Function allows the user to delay the start of the drying cycle by 6 or 9 hours.

When the function is first selected the display will show a delay of 6 hours, a subsequent press of the button will increase the delay to 9 hours.

To commence the programme press Start/Pause and the appliance will complete the drying cycle at the end of this time. The 6 or 9 hour indicator light will flash to indicate that the start delay is in progress.

Cleaning and Routine Maintenance

IMPORTANT

Always switch off and remove the plug from the electricity supply before cleaning this appliance.

For electrical data refer to the rating label on the front of the dryer cabinet (with the door open).

Cleaning the dryer

- Clean the filter and empty the water container after every drying cycle.
- Regularly clean the condenser.
- After each period of use, wipe the inside of the drum and leave the door open for a while to allow circulation of air to dry it.
- Wipe the outside of the machine and the door with a soft cloth.
- **DO NOT** use abrasive pads or cleaning agents.
- To prevent the door sticking or the build up of fluff periodically clean the inner door and gasket with a damp cloth.

Technical specifications

Drum capacity	115 litres
Maximum load	8 kg
Height	85cm
Width	60cm
Depth	60cm
Energy Label Band	C

Troubleshooting

What might be the cause of...

Defects you can remedy yourself

Before calling GIAS Service for technical advice please run through the following checklist. A charge will be made if the machine is found to be working or has been installed incorrectly or used incorrectly. If the problem persists after completing the recommended checks, please call the GIAS Service (tel: 08444 995599), they may be able to assist you over the telephone.

Drying time is too long/clothes are not dry enough...

- Have you selected the correct drying time/programme?
- Were the clothes too wet? Were the clothes thoroughly wrung or spin-dried?
- Does the filter need cleaning?
- Does the condenser need cleaning?
- Is the dryer overloaded?
- Are the inlets, outlets and base of the dryer free from obstructions?
- Has the 'Delicates' option been selected from a previous cycle?

The dryer does not operate...

- Is there a working electricity supply to the dryer? Check using another appliance such as a table lamp.
- Is the plug properly connected to the mains supply?
- Is there a power failure?
- Has the fuse blown?
- Is the door fully closed?
- Is the dryer switched on, both at the mains supply and at the machine?
- Has the drying time or the programme been selected?
- Has the machine been switched on again after opening the door?
- Has the dryer stopped operating because the water tray is full and needs emptying?

The dryer is noisy...

- Switch off the dryer and contact the GIAS service number 08444 995599 for advice.

The Filter Care Indicator is on...

- Does the filter need cleaning?
- Does the condenser need cleaning?

Empty Water Indicator is on...

- Does the water container need emptying?

Customer Service

If the supply cord on this appliance is damaged, it must be replaced by a special cord which is only available from GIAS Service or an authorised Hoover Dealer.

Should there still be a problem with your dryer after completing all the recommended checks, please call the national GIAS Service number for advice. They may be able to assist you over the telephone or arrange for a suitable appointment for an engineer to call under the terms of your guarantee. However, a charge may be made if any of the following applies to your machine:

- Is found to be in working order.
- Has not been installed in accordance with the installation instructions.
- Has been used incorrectly.

***Hoover
Spares
Service***

***Tel: 08443
712758***

HOOVER Spares

Always use genuine Hoover spares, available direct from GIAS Service.

GIAS Service

For service and repairs call your local engineer on our national number.

***Phone GIAS on
08444 995599
Eire – 0818 2000021***

Your Guarantee

For a period of one year from the date of purchase the appliance is covered by a guarantee which allows you to call GIAS Service free of charge.

Remember to send off the guarantee certificate for validation within 10 days of the date of purchase.

You should retain the receipt issued by the retailer when you purchased the machine to show to the call out engineer, should you need to consult one.

If your appliance shows signs of a defect or is not working properly, before you contact GIAS Service we recommend you carry out the checks detailed within the Troubleshooting section.

If the problem with the appliance persists after completing all the recommended checks, please dial the GIAS Service number.

You will be connected directly to GIAS. It is important you tell the GIAS advisor your product's model number and serial number, which you will find on the rating label (16 characters, beginning with the number 3), found on the front of the appliance (door area). By doing this, your enquiry will be responded to more efficiently.

Hoover guarantees all parts of this product for 5 years from the date of purchase. During that time Hoover will replace or repair all defective parts free of charge, except for parts subject to fair wear and tear such as belts. The call out fee and labour costs are chargeable after the first 12 months. To qualify for benefits under the guarantee, you must be able to provide proof of date of purchase and the appliance must have been installed and used in accordance with the instructions described in this manual.

Consequential losses and accidental damage to the machine is not covered by the guarantee.

Hoover cannot be responsible for the results of using this machine for any purposes other than those described in this manual.

This guarantee does not affect your statutory or common law rights.

Note: If repair work has been completed by an unauthorised engineer the product guarantee may become invalid.

Hoovercare

To maintain your Hoover product in peak condition you may wish to take out a Hoovercare policy, which for an annual payment provides a comprehensive maintenance and repair scheme. For more information please call 08444 995599. The Hoovercare scheme is not available in Eire.

The manufacturer declines all responsibility in the event of any printing mistakes in this booklet. The manufacturer also reserves the right to make appropriate modifications to its products without changing the essential characteristics.

