



HOVER



INSTRUCTION BOOK

DYC 890NB

Condenser Tumble Dryer

English

2

DYNAMIC
DRY

9KG



AQUA
VISION

Introduction	3
Delivery Information	3
Safety Reminders	3
Use	4
Installation	5
The Laundry	5
Ventilation	6
Environmental Issues	7
Gas Service	7
Installation	7
Electrical Requirements	7
Adjusting the Feet	7
Preparing the Load	8
Clothes Preparation	8
Do Not Tumble Dry	8
Energy Saving	8
Sorting the Load	8
Drying Guide	8
Controls and Indicators	9
Selecting the Programme	10
Door and Filter	11
Opening the Door	11
Filter	11
Filter Care Indicator	11
Water Container	11
To Remove the Container	11
Condenser	12
To Remove the Condenser	12
Operation	12
Delay Start Function	13
Cancelling and Resetting the Programme	13
Cleaning and Routine Maintenance	13
Cleaning the Dryer	13
Technical Specifications	13
Troubleshooting	14
Customer Service	14
Spares	14
Gas Service	14

INTRODUCTION

Please read and follow these instructions carefully and operate the machine accordingly. This booklet provides important guidelines for safe use, installation, maintenance and some useful advice for best results when using your machine.

Keep all documentation in a safe place for future reference or for any future owners.

Delivery Information

Please check that the following items are delivered with the appliance:

- Instruction manual
- Guarantee card
- Energy label

 Check that no damage has occurred to the machine during transit. If it has, call for service by GIAS.

 Failure to comply with the above can compromise the safety of the appliance. You may be charged for a service call if a problem with your machine is caused by misuse.

SAFETY REMINDERS

Use

- This appliance can be used by children aged from 8 years and above and persons with reduced physical, sensory or mental capabilities or lack of experience and knowledge if they have been given supervision or instruction concerning use of the appliance in a safe way and understand the hazards involved. Children shall not play with the appliance. Cleaning and user maintenance shall not be made by children without supervision. Children of less than 3 years should be kept away unless continuously supervised.
- **WARNING** Misuse of a tumble dryer may create a fire hazard.
- This appliances is intended to be used in household and similar applications such as:
 - Staff kitchen areas in shops , offices and other working environments;
 - Farm houses
 - By clients in hotels, motels and other residential type environments;
 - Bed and breakfast type environments"

A different use of this appliance from household environment or from typical housekeeping functions, as commercial use by expert or trained users, is excluded even in the above applications.

If the appliance is used in a manner inconsistent with this it may reduce the life of the appliance and may void the manufacturer's warranty. Any damage to the appliance or other damage or loss arising through use that is not consistent with domestic or household use (even if located in a domestic or household environment) shall not be accepted by the manufacturer to the fullest extent permitted by law."

INTRODUCTION

SAFETY REMINDERS

Use

- This machine should only be used for its intended purpose as described in this manual. Ensure that the instructions for installation and use are fully understood before operating the appliance.
- Do not touch the appliance when hands or feet are damp or wet.
- Do not lean on the door when loading the machine or use the door to lift or move the machine.
- Do not allow children to play with the machine or its controls.
- **WARNING** Do not use the product if the fluff filter is not in position or is damaged; fluff could be ignited.
- **WARNING** Where the hot surface symbol is  located the temperature rise during operation of the tumble dryer may be in excess of 60 degrees C.
- Remove the plug from the electricity supply. Always remove the plug before cleaning the appliance.
- Do not continue to use this machine if it appears to be faulty.
- Lint and fluff must not be allowed to collect on the floor around the outside of the machine.
- The final part of a tumble dryer cycle occurs without heat (cool down cycle) to ensure that the items are left at a temperature that ensures that the items will not be damaged.
- Maximum load drying weight :9 kg
- The tumble dryer is not to be used if industrial chemicals have been used for cleaning.
- **WARNING:** Never stop a tumble dryer before the end of the drying cycle unless all items are quickly removed and spread out so that the heat is dissipated.

INTRODUCTION

SAFETY REMINDERS

Installation

- Check that the product has no visible signs of damage before use. If damaged do not use and please call GIAS Service.
- Do not use adapters, multiple connectors and/or extensions.
- Never install the dryer against curtains and be sure to prevent items from falling or collecting behind the dryer.
- The appliance must not be installed behind a lockable door, a sliding door or a door with a hinge on the opposite side to that of the tumble dryer.
- Clothes should be spin dried or thoroughly wrung before they are put into the tumble dryer. Clothes that are dripping wet should not be put into the dryer.
- Lighters and matches must not be left in pockets and NEVER use flammable liquids near the machine.
- Glass fibre curtains should NEVER be put in this machine. Skin irritation may occur if other garments are contaminated with the glass fibres.

The Laundry

- Do not dry unwashed items in the tumble dryer.
- WARNING Do not tumble dry fabrics treated with dry cleaning fluids.
- WARNING Foam rubber materials can, under certain circumstances, when heated become ignited by spontaneous combustion. Items such as foam rubber (latex foam), shower caps, waterproof textiles, rubber backed articles and clothes or pillows fitted with foam rubber pads MUST NOT be dried in the tumble dryer.
- Always refer to the laundry care labels for directions on suitability for drying.
- Items that have been soiled with substances such as cooking oil, acetone, alcohol, petrol, kerosene, spot removers, turpentine, waxes and wax removers should be washed in hot water with an extra amount of detergent before being dried in the tumble dryer.
- Fabric softeners, or similar products, should be used as specified by the fabric softener instructions.

INTRODUCTION

SAFETY REMINDERS

Ventilation

- Adequate ventilation must be provided in the room where the tumble dryer is located to prevent gases from appliances burning other fuels, including open fires, being drawn into the room during operation of the tumble dryer.
- Installing the rear of the appliance close to a wall or vertical surface.
- There should be a gap of at least 12 mm between the machine and any obstructions. The inlet and outlet should be kept clear of obstruction. To ensure adequate ventilation the space between the bottom of the machine and the floor must not be obstructed.
- Check regularly that the air flowing through the dryer is not restricted.
- Check frequently the fluff filter after use, and clean, if necessary.
- Prevent items from falling or collecting behind the dryer as these may obstruct the air inlet and outlet
- NEVER install the dryer up against curtains.
- In cases where the dryer is installed on top of a washing machine, a suitable stacking kit must be used according to the follow configuration.
 - Stacking kit Mod 35100019: for minimum washing machine depth 49 cm
 - Stacking kit Mod 35900120: for minimum washing machine depth 51 cm

The stacking kit shall be one of that above, obtainable from our spare service.

The instructions for installation and any fixing attachments, are provided with the staking kit.

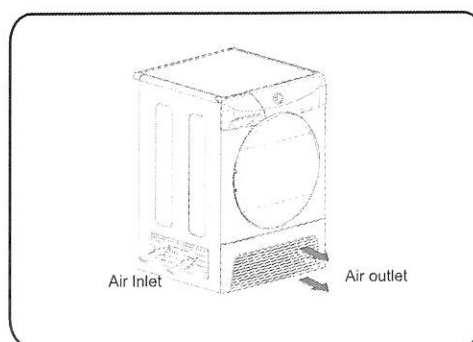

⚠ Do not install the product in a low temperature room or in a room where there is a risk of frost occurring. At temperature around freezing point the product may not be able to operate properly: there is a risk of damage if the water is allowed to freeze in the hydraulic circuit (valves, hoses, pumps). For a better product performance the ambient room temperature must be between +2°C and +35°C. Please note that operating in cold condition (between +2 and +15°C) might simply some water condensation and water drops on floor.

INSTALLATION

Environmental Issues

- All packaging materials used are environmentally-friendly and recyclable. Please help dispose of the packaging via environmentally-friendly means. Your local council will be able to give you details of current means of disposal.
- To ensure safety when disposing of an old tumble dryer disconnect the mains plug from the socket, cut the mains power cable and destroy this together with the plug. To prevent children shutting themselves in the machine break the door hinges or the door lock.

European Directive 2002/96/EC

This appliance is marked according to the European directive 2002/96/EC on Waste Electrical and Electronic Equipment (WEEE).



By ensuring this product is disposed of correctly, you will help prevent potential negative consequences for the environment and human health, which could otherwise be caused by inappropriate waste handling of this product.

The symbol on the product indicates that this product may not be treated as household waste. Instead it shall be handed over to the applicable collection point for the recycling of electrical and electronic equipment.

For more detailed information about treatment, recovery and recycling of this product, please contact your local city office, your household waste disposal service or the shop where you purchased the product. Disposal must be carried out in accordance with local environmental regulations for waste disposal.

GIAS Service

- To ensure the continued safe and efficient operation of this appliance we recommend that any servicing or repairs are only carried out by an authorised GIAS service engineer.

 If the appliance is not running properly or breaks down, switch it off and disconnect the plug from the socket. Consult GIAS Service for possible repair.

Electrical Requirements

Tumble dryers are supplied to operate at a voltage of 220-240V, 50 Hz single phase. Check that the supply circuit is rated to at least 13A.

Electricity can be extremely dangerous.

This appliance must be earthed. The socket outlet and the plug on the appliance must be of the same type. Do not use multiple adapters and/or extension leads.

The plug should be accessible for disconnection after the appliance has been installed.

CE Appliance complies with European Directive 2004/108/EC, 2006/95/EC and subsequent amendments.

 You may be charged for a service call if a problem with your machine is caused by incorrect installation.

 If the mains cord on this appliance is damaged, it must be replaced by a special cord which is ONLY obtainable from the spares service. It must be installed by a competent person.

 Do not plug the machine in and switch it on at the mains until the installation is completed. For your safety, this dryer must be correctly installed. If there is any doubt about installation, call GIAS Service for advice.

Adjusting the Feet

Once the machine is in place the feet should be adjusted to ensure that the machine is level.

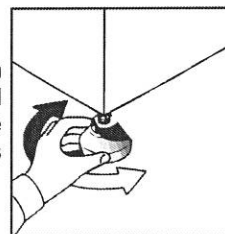

PREPARING THE LOAD

Before using the tumble dryer for the first time:

- Please read this instruction book thoroughly.
- Remove all items packed inside drum.
- Wipe the inside of the drum and door with a damp cloth to remove any dust which may have settled in transit.

Clothes Preparation

Make sure that the laundry you are going to dry is suitable for drying in a tumble dryer, as shown by the care symbols on each item.

Check that all fastenings are closed and that pockets are empty. Turn the articles inside out. Place clothes loosely in the drum to make sure that they don't get tangled.

Do Not Tumble Dry:

Woolens, silk, delicate fabrics, nylon stockings, delicate embroidery, fabrics with metallic decorations, garments with PVC or leather trimmings, training shoes, bulky items such as sleeping bags, etc.

⚠ IMPORTANT: Do not dry articles which have been treated with a dry cleaning fluid or rubber clothes (danger of fire or explosion).

During the last 15 minutes the load is always tumbled in cool air.

⚠ Do not overload the drum, large items when wet can exceed the maximum admissible clothes load (for example: sleeping bags, duvets).

Energy Saving

Only put into the tumble dryer laundry which has been thoroughly wrung or spin-dried. The drier the laundry the shorter the drying time thus saving electricity.

ALWAYS

- Try to dry the maximum weight of laundry, this will save time and electricity.
- Check that the filter is clean before every drying cycle.

NEVER

- Exceed the maximum weight, this will waste time and electricity.
- Put dripping wet items into the tumble dryer, this may damage the appliance.





Maximum Drying Weight

- Cottons **Max. 9 kg**
- Synthetics **Max. 4 kg**

Sort the Load as Follows

- By care symbols

These can be found on the collar or inside seam:

-  Suitable for tumble drying.
-  Tumble drying at high temperature.
-  Tumble drying at low temperature only.
-  Do not tumble dry.

If the item does not have a care label it must be assumed that it is not suitable for tumble drying.

- By amount and thickness

Whenever the load is bigger than the dryer capacity, separate clothes according to thickness (e.g. towels from thin underwear).

- By type of fabric

Cottons/linen: Towels, cotton jersey, bed and table linen.

Synthetics: Blouses, shirts, overalls, etc. made of polyester or polyamid, as well as for cotton/synthetic mixes.

- By drying level

Sort into: iron dry, cupboard dry, etc. For delicate articles press the Delicates button to select low drying temperature.

Drying Guide

The standard cycle HANG DRY () is the most energy efficient and best suited for drying normal wet cotton laundry.

The table below shows the approximate time and energy consumption of the main drying programmes.

CYCLE	LOAD	ENERGY (kWh)	TIME (Min)
All Towels	FULL	6,24	225
Store Dry	FULL	5,88	205
Hand Dry	FULL	5,20	176
Hang Dry	HALF	2,80	100
Iron Dry	FULL	4,16	144
Power consumption of "left on-mode"			0,75 W
Power consumption of "off-mode"			0,15 W

CONTROLS AND INDICATORS

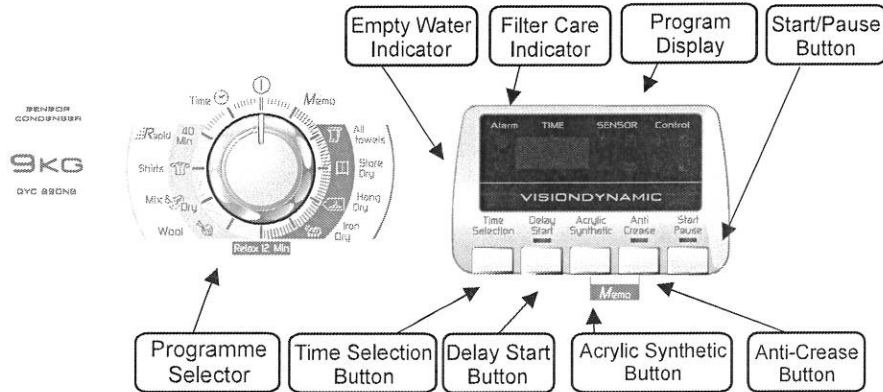

Control Panel and Indicator Lights

Programme Selector – Select the required programme

Time Selection Button – Allows the user to change duration of the programme selected by Programme Selector. It can be used only with the selection of: Mix&Dry, Shirts and Time Programmes

Delay Start Button – Allows the user to delay the start of the drying cycle (see details of Operation)

Acrylic and Synthetic Button – When pressed the default indicator will fade and will be illuminated

Anti-Crease Button – Allows the user to select a post drying anti-crease cycle.

Start/Pause Button – Press to commence/ to pause the selected drying programme.

Memo Button – Allows user to record the programme by pressing simultaneously the Anti-Crease and the Acrylic Synthetic buttons for 3 seconds, after 2 minutes duration of the chosen programme/option

Filter Care indicator – lights when the filter needs cleaning

Empty Water indicator – lights when the water container is full

Program Display – Related indicator lights when a auto programme has been selected.

- Indicator will come on when the eco programme has been selected.

Refresh – The indicator lights up when the programme starts the cool down stage.

SELECTING THE PROGRAMME



This machine has a special Sensor Dry to help you choose your preferred programme simply by selecting the level of dryness wanted.









For small loads and pre-dried clothes, please use a Timing programme and select "Delicate fabrics" button to lower the temperature inside the drum.

If the Sensor does not detect any item, this Dryer will work for only 10 minutes before starting the Cool down phase.

If the load is too big or too wet, this Dryer will automatically work for 3 hours and then start the Cool down phase.

At the end of each programme, there is always the Cool Down phase: it is a cool-air refresh phase of around 15 minutes.

SELECTING THE PROGRAMME

PROGRAMME	IDEAL FOR
All towels 	Clothes you want completely dried, e.g. towels, bathrobes, table clothes or sheet. Time: around 3h.
Store Dry 	Clothes you want to fold and store without ironing, e.g. shirts in mixed fabrics, socks, baby clothes. Time: around 2h and 45 min.
Hang Dry 	Clothes you don't need to iron, but just hang after the drying cycle. Time: around 2h and 30 min.
Iron Dry 	Leave clothes slightly damp to allow easier ironing. Time: around 1h and 50 min.
Relax 12 Min. 	Clothes you just need to refresh. Good for items of clothing which have been left prior to ironing or if they have been dried outside or on radiators. This programme has a specific Anti-Crease function that relaxes fibres and makes easier ironing. Time: 9 min + 3 min cool down.
Wool 	To soften your woollen clothes or to simply refresh them after a long time in the wardrobe. Time: 12 min.
Mix & Dry	To dry mixed cotton and synthetic clothes: save time and no need to separate the washing and dry them in different cycles. Time: around 2h (max 4 kg).
Shirts 	To dry shirts both cotton and synthetic fabrics. Time: 1h for 2kg of synthetic shirts (around 10 shirts); 1h and 20 min for 3 kg of cotton shirts (around 10 shirts).
Rapid 40'	For dry, refreshed and ready to dress clothes in only 40 minutes. Sensor system keeps under control the temperature to have always the best result. Max 2 kg.
Time 	If you want to choose drying times, from 30 to 180 minutes. By selecting "20 min" you choose a "cool programme", ideal to refresh clothes and to remove eventual smells.
Memo	Memo Program allows to re-perform a program that the user has saved before, without selecting the correct sequence of program selector positions and option buttons for that particular program. filters and air duct. This programme works for around 2h, but time can change according to dimensions, density of load or washing spin speed. At the end of the cycle, the duvet is ready for use; if some parts are slightly wet, please shake the load and re-start the programme for few minutes. If you need to dry a duvet filled with synthetic fabrics, please push "Delicate fabrics" button.

DOOR and FILTER

Opening the Door

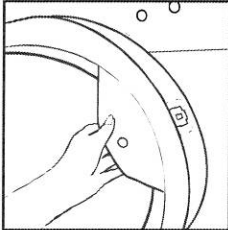

Pull on handle to open the door.

To restart the dryer, close the door and press Start/Pause button.

⚠ WARNING! When the tumble dryer is in use the drum and door may be VERY HOT. Never stop a tumble dryer before the end of the drying cycle unless all items are quickly removed and spread out so that the heat is dissipated.

Filter

IMPORTANT: To maintain the efficiency of the dryer check that the fluff filter is clean before each drying cycle.

1. Pull the filter upwards.

2. Open filter as shown.

3. Gently remove lint using a soft brush or your fingertips.

4. Snap the filter together and push back into place.

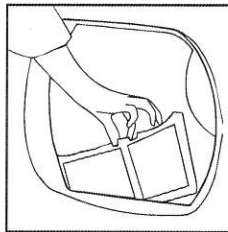

Filter Care Indicator

 Lights when the filter needs cleaning.

If the laundry is not drying check that the filter is not clogged.

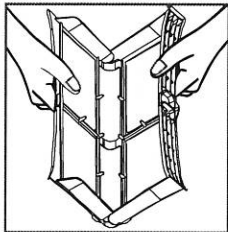

⚠ DO NOT USE WATER TO CLEAN THE FILTER.

WATER CONTAINER

The water removed from the laundry during the drying cycle is collected in a container at the bottom of the dryer. When the container is full the  indicator on the control panel will light, and the container **MUST** be emptied. However, we recommend that the container is emptied after each drying cycle.

NOTE: Very little water will collect during the first few cycles of a new machine as an internal reservoir is filled first.

To Remove the Container

1. Gently pull the bottom of the kickplate so that it unclips from the dryer. The top section can then be unhinged allowing the kickplate to be completely removed.

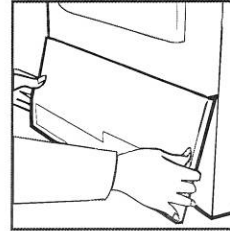

2. Pull firmly on the handgrip and slide the water container out of the dryer.

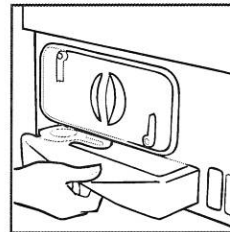

Support the container with both hands. When full, the water container will weigh about 4kg.

3. Open the lid located on the top of the container and empty the water.

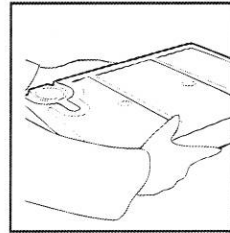

4. Refit the lid and slide the water container back into position.

PUSH FIRMLY INTO PLACE.

5. Refit the kickplate by engaging the hinges at the top and 'snapping' the lower clips into place.

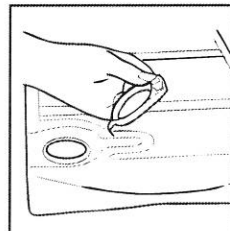

CONDENSER

Important: Always switch off and remove the plug from the electricity supply before cleaning the condenser.

To maintain the efficiency of the dryer regularly check that the condenser is clean.

OPERATION

To Remove the Condenser

1. Remove the kickplate.

2. Turn the two locking levers anti-clockwise and pull out the condenser.

3. Pull out the condenser unit.

4. Gently remove any dust or fluff with a cloth, then wash the unit by holding it under a running tap turning it so that water flows between the plates, to remove any dust or fluff.

5. Check the gasket position after cleaning. Fit the gasket in to the groove if it is misaligned.

6. Refit the condenser ensuring it is in the correct way (as indicated by the arrow) and pushed firmly into place. Lock the two levers by turning them clockwise. Be sure that condenser unit fixed to the basement tightly.

7. Refit the kickplate.

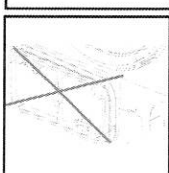
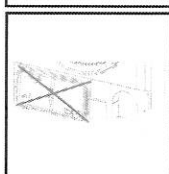
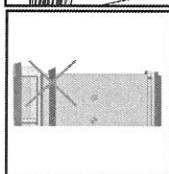
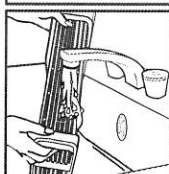
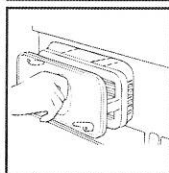
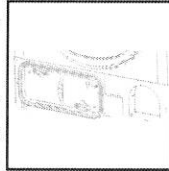
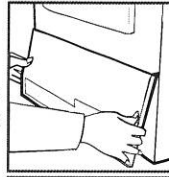
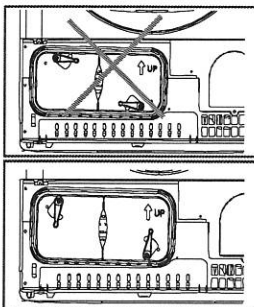

1. Open the door and load the drum with laundry. Ensure that garments do not hinder closure of the door.

2. Gently close the door pushing it slowly until you hear the door 'click' shut.

3. Turn the Programme Selector dial to select the required drying programme (see Programme Guide).

4. If drying synthetics, acrylics or delicate items, press the Delicates button to reduce the heat level.

The light next to the push button will light up when the machine is in low heat setting. To deselect in the first few minutes of the programme, press the Delicates button, after this time reset the machine to change the setting.

5. Press the Start/Pause button. The dryer will start automatically and the DRY indicator will be continuously lit.

6. If the door is opened during the programme to check the laundry, it is necessary to press Start/Pause to recommence drying after the door has been closed.

7. When the cycle is nearing completion the machine will enter the cool down phase, the clothes will be tumbled in cool air allowing the load to cool down.

8. When the programme is complete the END indicator will light.



9. Following the completion of the cycle the drum will rotate intermittently to minimize creasing. This will continue until the machine is switched OFF or the door is Opened.

OPERATION

Delay Start Function

The Delay Start Function  allows the user to delay the start of the drying cycle by 1 to 24 hours.

When the function is first selected the display will show a delay of 1 hour, subsequent presses of the button will increase the delay with 1 hour steps.

To commence the programme press  and the appliance will complete the drying cycle at the end of this time. The indicator light  will flash to indicate that the start delay is in progress.

Cancelling and Resetting the Programme

To cancel a programme press the  button for 3 seconds. In the TIME CONTROL display 0:00 Light will flash to indicate that it has been reset.

CLEANING AND ROUTINE MAINTENANCE

Cleaning the Dryer

- Clean the filter and empty the water container after every drying cycle.
- Regularly clean the condenser.
- After each period of use, wipe the inside of the drum and leave the door open for a while to allow circulation of air to dry it.
- Wipe the outside of the machine and the door with a soft cloth.
- DO NOT use abrasive pads or cleaning agents.
- To prevent the door sticking or the build up of fluff periodically clean the inner door and gasket with a damp cloth.

 **WARNING!** The Drum, door and load may be very hot.

Technical Specifications

Drum capacity	115 litres
Maximum load	9 kg
Height	85 cm
Width	60 cm
Depth	60 cm
Energy Label Band	B

Information for Test Laboratory

<u>EN 61121 Programme</u>	<u>Programme To Use</u>
-DRY COTTON	-HANG DRY
-IRON DRY COTTON	-IRON DRY
-EASY-CARE TEXTILE	-HANG DRY + SYNTHETIC

 **IMPORTANT** Always switch off and remove the plug from the electricity supply before cleaning this appliance.

 For electrical data refer to the rating label on the front of the dryer cabinet (with the door open).

TROUBLESHOOTING

What Might be the Cause of...

Defects you can remedy yourself

Before calling GIAS Service for technical advice please run through the following checklist. A charge will be made if the machine is found to be working or has been installed incorrectly or used incorrectly.

If the problem persists after completing the recommended checks, please call GIAS Service, they may be able to assist you over the telephone.

Drying time is too long/clothes are not dry enough...

- Have you selected the correct drying time/programme?
- Were the clothes too wet? Were the clothes thoroughly wrung or spindried?
- Does the filter need cleaning?
- Is the dryer overloaded?
- Has the Delicates option been selected from a previous cycle?

The dryer does not operate...

- Is there a working electricity supply to the dryer? Check using another appliance such as a table lamp.
- Is the plug properly connected to the mains supply?
- Is there a power failure?
- Has the fuse blown?
- Is the door fully closed?
- Is the dryer switched on, both at the mains supply and at the machine?
- Has the drying time or the programme been selected?
- Has the machine been switched on again after opening the door?

The dryer is noisy...

- Switch off the dryer and contact GIAS Service for advice.

The Filter Care Indicator is on...

- Does the filter need cleaning?

The Empty Water Indicator is on...

- Does the water container need emptying?

CUSTOMER SERVICE

Should there still be a problem with your dryer after completing all the recommended checks, please call GIAS Service for advice.

They may be able to assist you over the telephone or arrange for a suitable appointment for an engineer to call under the terms of your guarantee. However, a charge may be made if any of the following applies to your machine:

- Is found to be in working order.
- Has not been installed in accordance with the installation instructions.
- Has been used incorrectly.

 If the supply cord on this appliance is damaged, it must be replaced by a special cord which is only available from GIAS Service or an authorised Hoover Dealer.

Spares

Always use genuine spares, available direct from GIAS Service.

Spares Service Tel: 08443 712758

GIAS Service

For service and repairs call your local GIAS Service engineer.

Phone GIAS on 08444 995599

Eire – 0818 200021

The manufacturer declines all responsibility in the event of any printing mistakes in this booklet. The manufacturer also reserves the right to make appropriate modifications to its products without changing the essential characteristics.



40009052