

INSTRUCTION BOOK

Instructions for installation and use

WDYN D

DYNAMIC
8+5^{W&D}



GENERATION FUTURE

CONTENTS

Introduction	3
Delivery Information	3
Guarantee	3
Customer Service	4
Caring for the Environment	5
Warning and Safety Instructions	6
Unpacking the Product	8
Installation	9
Electricity Supply	9
Water Supply	10
Connecting the Cold Water Supply	11
Connecting the Drainage Pipe	12
Levelling the Machine	13
Testing the Installation	13
Description of the Machine	15
The Control Panel	16
Digital Display	17
Wash Options	19
Dry Options	21
Automatic Features	22
Programme Descriptions	23
Programme Guide	26
Detergent	28
Laundry	29
Washing Advice	30
Running a Wash Cycle	31
Drying Advice	33
Running a Dry Cycle	34
Care and Maintenance	36
Problem Solving Guide	38
After Sales Service	42

INTRODUCTION

Please read and follow these instructions carefully and operate the machine accordingly. This booklet provides important guidelines for safe use, installation, maintenance and some useful advice for best results when using your machine.



Please complete the information below referencing your products details found on the rating plate that is attached to the porthole of your machine:

Model Number: _____

Serial Number (16 digits): _____

Our customer service advisors will require this information whenever you contact Hoover. Please keep all documentation in a safe place for future reference or for any future owners.

DELIVERY INFORMATION

Please check that the following items are delivered with the appliance:

- Instruction manual
- Guarantee card
- Blanking plugs
- Inlet hose

Check that no damage has occurred to the machine during transit.

GUARANTEE

Your new Hoover appliance comes with a 12-month call-out, parts and labour guarantee. Registering your appliance also gives you an additional 4-year parts guarantee absolutely free. To activate both your 12-month and 4 year guarantees, you must register your appliance within 30 days, quoting your model number, serial number, plus the date and price of you purchase.

Register your appliance now by calling

08444 810 157

or register online

www.hoover.co.uk

If you would like to register for an additional 4 years labour protection, please ask our service advisor for cost details, or complete the enclosed form.

CUSTOMER SERVICE

At Hoover, we aim to make appliances that are reliable and long lasting. However, should your appliance need to be serviced during its working life, no one is more qualified to maintain your appliance than our own Hoover Service engineers. To book a service call or to ask our customer service advisors for help on using your appliance, please call:

08705 400 600

Alternatively, you can consult our Problem Solving Guide on page 38.

TECHNICAL DATA	
■ Max. load of dry laundry for washing	8 kg
■ Max. load of dry laundry for drying	5 kg
■ Water pressure	0.05 ÷ 0.8 MPa
Measurements	
■ Height	85 cm
■ Width	60 cm
■ Depth	54 cm

NB: For specifications regarding electrical data, see the data panel on the front of the washing machine (porthole area).

CARING FOR THE ENVIRONMENT

Together, we share the responsibility to safeguard our environment for future generations.

At Hoover, that means continually developing new, intelligent technologies to produce electrical appliances that perform more efficiently and use less electricity and less water. This significantly reduces the carbon footprint from your appliance.

Our ongoing commitment will ensure that we will continue to develop more intelligent, more efficient appliances for future generations.

EUROPEAN DIRECTIVE 2002/96/EC

This appliance is marked according to the European directive 2002/96/EC on Waste Electrical and Electronic Equipment (WEEE).

By ensuring this product is disposed of correctly, you will help prevent potential negative consequences for the environment and human health, which could otherwise be caused by inappropriate waste handling of this product.

The symbol on the product indicates that this product may not be treated as household waste. Instead it shall be handed over to the applicable collection point for the recycling of electrical and electronic equipment.

Disposal must be carried out in accordance with local environmental regulations for waste disposal.

For more detailed information about treatment, recovery and recycling of this product, please contact your local city office, your household waste disposal service or the shop where you purchased the product.



WARNING AND SAFETY INSTRUCTIONS

This machine is solely for domestic use, i.e. to wash, rinse and spin dry household textiles and garments.

Do not touch the appliance when hands or feet are damp or wet.

Do not lean on the door when loading the machine or use the door to lift or move the machine.

Do not try to open the door when water is visible in the drum or the door locked indicator is ON.

Do not touch the drained water as it may reach extremely high temperatures.

Do not use adapters, multiple connectors and / or extensions leads.

Do not pull the power cord or the appliance itself to remove the plug from the socket.

Ensure the appliance mains supply is earthed, and if it is not, seek assistance from a qualified person.

If the power cable is damaged, it must only ever be replaced by an authorised serviceman.

Never force the porthole door: doing so may damage the safety lock mechanism designed to prevent the door being opened accidentally.

This appliance is not intended for use by persons (including children) with reduced physical, sensory or mental capabilities, or lack of experience and knowledge, unless they have been given supervision or instruction concerning use of the appliance by a person responsible for their safety.

Children should be supervised to ensure that they do not play with the appliance.

When moving the appliance, never lift it by the controls, detergent drawer or door, and never attempt to move it alone as the machine is extremely heavy.

When in transit, never rest the door against the trolley or transport the appliance without its polystyrene base.

If the appliance is installed on a carpeted floor ensure that the ventilation holes on the base of the appliance are not obstructed.

The appliance must not be installed behind a lockable door, a sliding door or a door with a hinge on the opposite side to that of the washer dryer.

If the appliance is not running properly or breaks down, switch off the power, turn off the tap and do not tamper with the appliance. Contact an authorised serviceman and ask them to use official Hoover spare parts.

Warning! The company denies all liability if and when these instructions are not respected.

UNPACKING THE PRODUCT

Remove the machine from its packaging close to the final location of the machine.

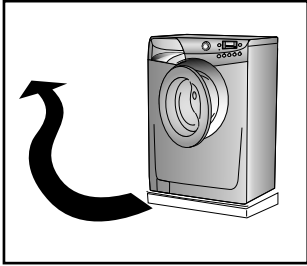

Step 1. Remove all outer packaging from the machine. Check there is no damage to the machine before continuing the installation process.

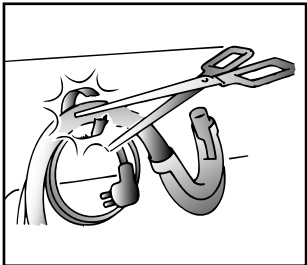

Step 2. Carefully cut through the hose-retaining clip at the rear of the machine, taking care not to cut the hose itself.

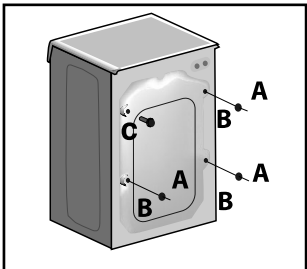

Step 3. Remove the 3 retaining screws (A) at the rear of the machine, as indicated in the image on the left.
Remove the screw (C).
A spacer will fall inside the machine.
By tilting the machine, remove the above mentioned spacer.
Use the blanking plugs provided in the instruction booklet pack to cover the holes once the screws have been removed.

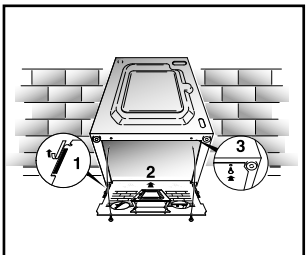

Step 4. Tilt the machine forward and apply the insulation base panel (corrugated plastic) to the base of the machine using the self-adhesive strips.

All packaging materials used are environmentally friendly and recyclable. Please help dispose of the packaging via environmentally friendly means. Your local council will be able to give you details of current means of disposal.

INSTALLATION

Before installing the machine, ensure that the mains plug and water supply valves are easily accessible from your chosen machine location.

Make sure there is enough space for the machine. Select a space at least 600mm wide and 850mm high. Also leave enough space to open the door fully so you can load and unload it easily.

Keep the area underneath and around the machine free of combustible materials such as lint, paper, rags, chemicals etc.

All machines are tested with water prior to leaving the factory, so a small amount of water may be present in the drum and the drain hose.

Flooding may occur if any part of the installation process is not completed correctly.

ELECTRICITY SUPPLY

Washing machines are supplied to operate at a voltage of 230-240V, 50 Hz single phase. Please check that the supply circuit is rated to at least 13A.

The plug is already equipped with a 13A fuse, which is BS 1362 ASTA approved. Any replacement must be the same rating and specification. **If the fuse cover is lost, do not use the plug until it is replaced.**

Electricity can be extremely dangerous. Please take care when connecting your machine to the electricity supply.

This washing machine must be earthed.

The socket outlet and the plug on the appliance must be of the same type.

Do not use multiple adapters and/or extension leads.

The wires in the mains lead are coloured in accordance with the following codes:

Blue	NEUTRAL
Brown	LIVE
Green and Yellow	EARTH

CE Appliance complies with European Directive 73/23/EEC, 89/336/EEC replaced by 2006/95/EC and 2004/108/EC and subsequent amendments.

WATER SUPPLY

This machine should only be connected to a **cold-water** supply. The cold-water pressure should be between 0.5 and 8 bar (0.05-0.8 Mpa).

Do not connect the machine to a single outlet instantaneous water heater.

Before connecting the fill hose, check that the water is running from the water supply tap to be used. Let the water flow from the tap until the water runs clear before connecting to the machine. The water supply tap should be accessible when the machine is installed.

CONNECTING THE COLD WATER SUPPLY

Only one hose is required to install this machine to a cold water supply. Cold fill is an energy efficient system. Only the water required to wash the laundry is heated. There is no loss of heat in the pipeline from the hot water tank or the boiler.

If your previous machine installation was hot and cold fill ensure that the hot tap is firmly closed to prevent leakage.

This machine has an inlet hose with a 19mm (3/4") threaded ferrule fitted to the end, to attach between the threaded connector on the appliance and the water supply. Only use the new hose supplied to connect the machine and ensure that the sealing washers are in place inside the hose connectors.

Do not re-use old hoses that are attached to existing installations.

Do not over-tighten the connections. Hand tight is sufficient.

Do not trap or kink the hose.

Step 1. Connect the elbow end of the hose provided to the threaded inlet on the back of the machine.

The grey pipe needs to connect to the white threaded inlet on the machine.

Step 2. Hand tighten the connector.

Step 3. Connect the straight ends of the pipes to the water supply; **ensure that there are no kinks.**

Step 4. Turn on the water supply and check there are no leaks. If there is a leak, turn off the water supply, disconnect the hose and check the sealing washers are in place. Refit the hose and turn on the water supply.

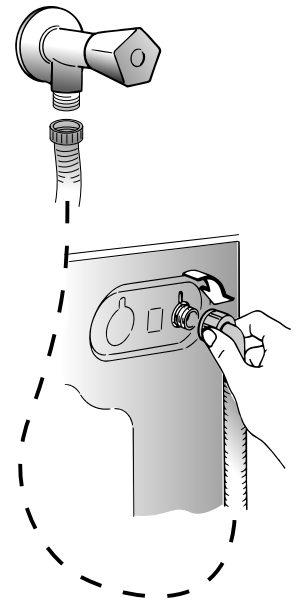

CONNECTING THE DRAINAGE PIPE

This machine must be connected in accordance with the water supply regulations. Water bylaws prohibit connection to a surface water drain.

Decide which plumbing option suits you best then follow the instructions below:

Option 1 - Waste pipe connection (waste trap)

Fit the hooked end support to the outlet pipe and position it at least 800mm off the floor.

After removing the blanking plug, or cutting the membrane from the waste system, securely fix the outlet pipe to the drainage system, using a hose clip.

Secure the hooked end support up to at least 800mm to avoid water being drawn back into the machine.

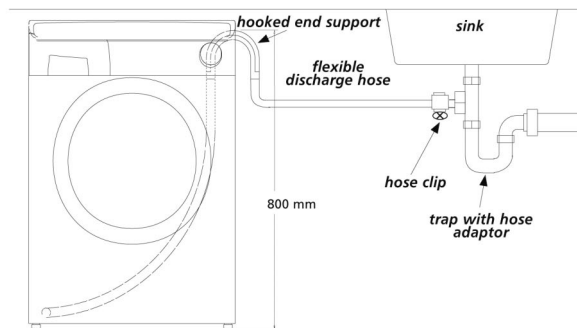
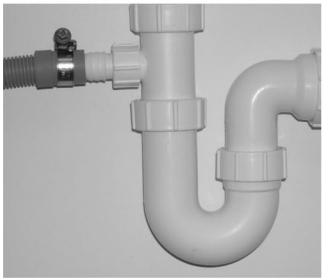

Option 2 - Into a standpipe

Ensure that the standpipe is not located near an electrical socket.

Fit the hooked end support to the outlet pipe. Install the hose into the standpipe ensuring that the pipe is at least 500mm from the floor.

Insert the outlet pipe approximately 100mm into the standpipe.

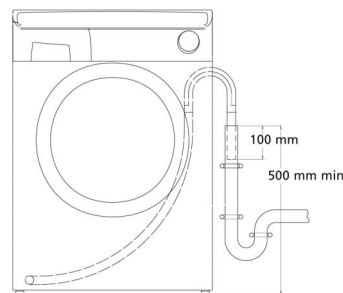
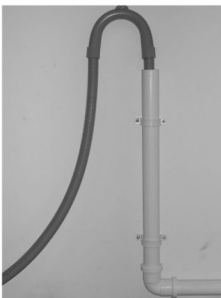

LEVELLING THE MACHINE

Your machine is heavy so care must be taken when moving it. We recommend that two people move the machine to avoid strain and possible injury. Take care not to damage flooring when moving the machine and **do not drag or lift the machine by its door**.

When moving the machine to its final position, take care not to kink or damage the hose at the back of the machine.

Once the machine is in place the feet should be adjusted to ensure that the machine is level. If the machine is not level it may become very noisy or move during the spin cycle.

Step 1. Turn the locking nut clockwise to release the screw adjuster on the feet.

Step 2. Adjust the feet on the corners of the machine by rotating each foot to raise or lower its position until it is firm and level on the ground.

Step 3. When the machine is firm and level, tighten the locking nuts on the feet in an anti-clockwise direction until they reach the base of the machine.

TESTING THE INSTALLATION

Refer to "Selecting the wash programme" for details of how to select programmes.

Step 1. Turn on the water supply and check for leaks from the fill hose.

Step 2. Switch on the electricity supply.

Step 3. Select the spin programme and then press the Start Pause button to start the machine. Allow the programme to continue for one minute and then cancel the programme by returning the selector to the OFF position. This will remove any water remaining in the machine from factory testing.

Step 4. To check for cold water filling to the machine:

Select the rinse programme and press the Start Pause button to start the machine.

Once the rinse has finished, allow the tumble action to continue until the water has pumped out. Check that the drain outlet is not leaking or overflowing.

Step 5. Switch off the machine at the end of the cycle by turning the Programme Selector to the OFF position.

Step 6. Select the spin programme and press the Start Pause button to start the machine. If the machine takes longer than one minute to empty check the drain hose for kinks.

Installation testing is now complete.

Now you have successfully installed the machine we advise that you run the machine to ensure the drum is thoroughly clean after testing and storage. Select Cottons 90°C programme and run the machine for a complete cycle using only wash detergent and water.

This programme will take approximately 2 hours to complete.

DESCRIPTION OF THE MACHINE

The Hoover Washer Dryer details are indicated below:



THE CONTROL PANEL

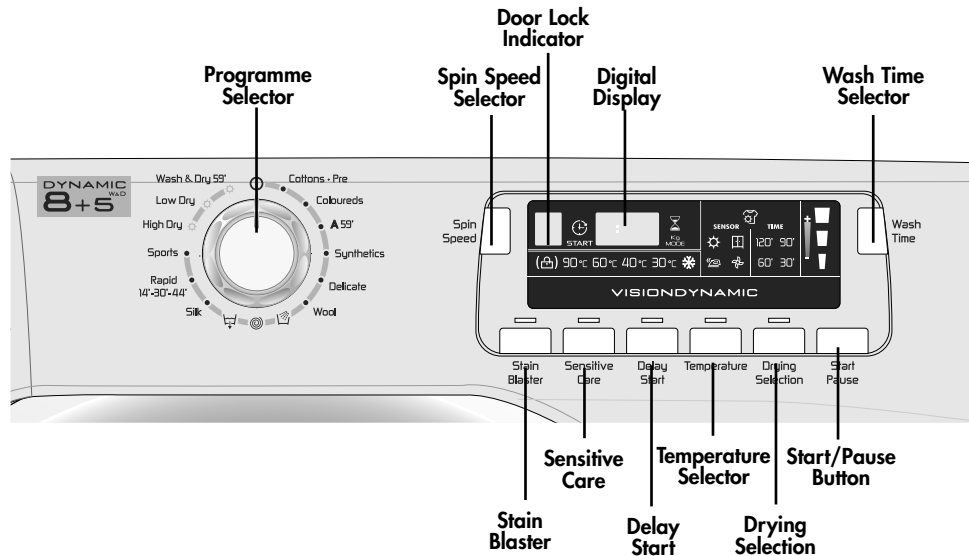

Turning the Machine On

Turning the Programme Selector to your chosen programme will turn the machine on. The Programme Selector must be returned to the OFF position between each wash cycle in order to reset the controls.

Start Pause Button START

After selecting the programme and the required options press the Start Pause button once to start the wash cycle. There will be a short time delay to the start of the programme while the machine sets the wash parameters for the selected programme and options. The Door Locked and KG Mode indicator lights will also illuminate a few seconds after pressing the Start Pause button.

PAUSE

The programme may be paused at any time during the wash cycle by holding down the Start Pause button for about two seconds. The door locked indicator light will remain illuminated for approximately 2 minutes. The door can be opened when this indicator goes out. To restart the programme, press the Start Pause button once again.

Cancelling and Changing the Programme

To cancel the programme the Programme Selector should be rotated to the OFF position. Select a new programme and start as detailed above.

DIGITAL DISPLAY

The easy-to-use Digital Display gives you total control of your wash cycle, whether it is adjusting the wash length using our Wash Time Selector, delaying the start of your wash, or adjusting the temperature and spin speed of your selected programme. The simplicity of the Digital Display understates the advanced technology, which clearly displays all the wash cycle information, putting you in control.

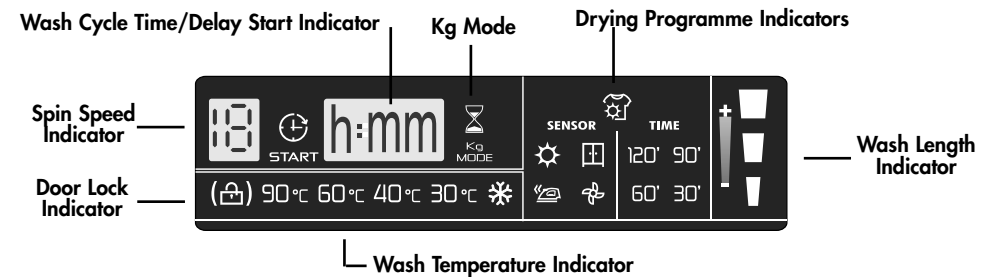

Wash Temperature

When a programme is selected the relevant indicator will light up to show the recommended wash temperature. You can select a different temperature by pressing the Temperature button. For example: The Cottons programme will default to 40°C.

With this control the temperature can be reduced to 30°C to reduce energy consumption or increased to 60°C for a more intensive wash.

Today, most detergents have been improved to wash efficiently at lower temperatures, therefore we have set the default temperature settings of each programme to a lower level, saving electricity and reducing the carbon footprint of your machine.

Please refer to the Programme Guide for the maximum temperature to which each programme can be set.

Door Locked indicator

The Door Locked indicator light is illuminated when the door is fully closed and the machine is ON.

When Start Pause is pressed on the machine with the door closed the indicator will flash momentarily and then illuminate. If the door is not closed the indicator will continue to flash. A special safety device prevents the door from being opened immediately after the end of the cycle. Wait for 2 minutes after the wash cycle has finished and the door locked light has gone out before opening the door. As a safety measure, check that there is no water evident in the drum. At the end of the cycle turn the programme selector to OFF.

If the programme is paused, the door locked indicator will go out after 2 minutes and the door can be opened. Check there is no water evident in the drum before opening the door.

Spin Speed

When a programme is selected the maximum spin speed allowed for that programme appears on the display. Pressing the Spin Speed button will reduce the speed by 100rpm each time the button is pressed. The minimum speed is 400rpm, or continuing to press the button will eliminate the final spin completely.

Delay Start

This indicator shows the number of hours time delay, once the delay start has been set.

Wash Cycle Time

When a programme is selected the display automatically shows the maximum cycle duration for a full load, which can vary, depending on the options selected. Once the programme has started you will be kept informed constantly of the time remaining to the end of the wash.



If is selected the automatic washing/drying cycle, at the end of the wash phase, the drying time remaining to the end will be shown on the display.

KG Mode Indicator

Available on Cotton and Synthetic cycles, during the first 4 minutes of the cycle the indicator lights and wash time will flash. This means the intelligent sensor is weighing the laundry and will adjust the cycle time, water and electricity consumption accordingly.

Drying Programme Indicators

Hoover washer dryers incorporate an Automatic Sensor Drying function which takes the guesswork out of setting the drying time. You simply select the degree of dryness you require and the dryer automatically switches off when that level is reached. For added flexibility there are 3 Sensor Drying levels to choose from:

-  = Extra dry programme
-  = Store dry programme
-  = Iron dry programme

Once the programme option has been selected, press the Start Pause button. The appliance will then calculate the time to the end of the selected programme based upon a full dry load. During the cycle the appliance will update the time to suit the actual load size and dampness of the fabrics.

Timed programmes:

Alternatively you may select a pre-determined time for the drying cycle. The Timed Drying programmes may be set to the following times:
120 minutes – 90 minutes – 60 minutes – 30 minutes

Cool down phase :

A 10 minute cool down phase occurs at the end of each drying cycle to ensure clothes are not too hot to touch when the cycle finishes.

Wash Length Indicator

Once the programme has been selected the indicator light will automatically show the wash time set for that programme. Selecting a different wash time the relevant indicator will light up.

WASH OPTIONS

The following options should be chosen once the required programme has been selected and BEFORE pressing the Start Pause button. The indicator light on each option button will illuminate if that option has been selected.

Stain Blaster

The Stain Blaster option, selectable on all Cotton cycles, tackles stubborn stains by maintaining wash temperatures throughout the programme and adjusting the spin speed of the drum during critical stages of the wash and rinse cycles. Using this special programme will increase the wash efficiency without increasing the length of your wash programme.

Sensitive Care

The Sensitive Care option washes your clothes in a deeper than normal water level to provide gentler washing for especially delicate fabrics, while detergent is removed thoroughly with five extra rinses. Perfect for people with delicate skin, this option can be selected on all Cotton and Synthetic cycles.

This option does not need to be selected on the Delicate, Woollen or Silk programmes, as it is already an integrated part of the wash cycles.

Delay Start

This option allows you to delay the start of your wash cycle by up to 24 hours. By pressing the Delay Start button, the time delay will be shown on the display (h00). This will increase in one-hour intervals each time the Delay Start button is pressed. Continue to press the button until the required time is reached, then press the Start Pause button to activate the machine. The machine will start its cycle once the required number of hours has passed.

To cancel the Delay Start option, press and hold the button for 5 seconds until the display shows the settings for the selected programme. To start this programme, press the Start Pause button. To cancel the process, turn the Programme Selector to the OFF position  and then select another programme.

Temperature

When a programme is selected the relevant indicator will light up to show the recommended wash temperature. The Temperature button can be used to decrease or increase the temperature of your chosen wash cycle. Each time the button is pressed, the new temperature level is shown on the Wash Temperature Indicator.

Spin Speed

The spin cycle is used to remove as much water as possible from the laundry without damaging your clothes. The recommended spin speed for each programme is already set to the highest level for that chosen programme. By pressing the Spin Speed button you can reduce the spin speed in 100rpm intervals.

To cancel the spin cycle altogether, set the spin speed to 0.

It is not possible to select a spin speed higher than that suitable for the programme selected. This feature is designed to avoid damage to your clothes.

It is possible to modify the spin speed at any time without stopping or pausing the machine.

Wash Time Selector

Once the programme has been selected the indicator light will automatically show the wash time set for that programme. Selecting a different wash time the relevant indicator will light up. For example: Using this button on the Rapid Wash cycle will enable you to select either a 14, 30 or 44 minute wash cycle.

This selection is only available on the Cotton, Synthetic and Rapid programmes.

DRY OPTIONS





Once the washing cycle has finished, remove some of the clothes if necessary to reduce the load size to the maximum drying weight (see Programme Guide pg.26). Use the programme dial to select the heat level required. High Dry should be used for cottons or Low Dry for synthetics. Avoid mixing cottons and synthetics to ensure there is no damage to the garments.

Select the required drying cycle by pressing the Drying Selection button until the chosen cycle is illuminated on the display (or until no indicator are illuminated if you wish to cancel the drying selection). Press the Start Pause button to start the drying cycle.

If the drying cycle has been selected before the wash cycle is completed the machine will automatically commence to the drying programme. Refer to the Programme Guide (pg.26) to identify which heat level will be automatically selected after the wash programme. To protect your laundry, some wash programmes (e.g. Silk) cannot be automatically followed by a drying cycle.

To cancel the drying cycle once the programme has started, hold the Drying Selection button down for a few seconds until the Cool Down indicator lights up. We recommend that you let the Cool Down period complete before removing the laundry, as the laundry would be too hot to handle without this phase.

Once the drying cycle has finished, return the programme dial to the OFF position.

	Programme	Description
Sensor Dry Programmes	Extra Dry 	Longer drying cycle suitable for towels, bathrobes and bulky loads
	Store Dry 	Standard drying cycle for items that can be put away without ironing
	Iron Dry 	Leaves the laundry slightly damp which makes fabrics easier to iron
Time Dry Programmes	120'	120 Minutes of drying
	90'	90 Minutes of drying
	60'	60 Minutes of drying
	30'	30 Minutes of drying (advisable for loads of less than 1kg)
Airing Programmes	Cool Down 	Tumbling of laundry in cool air for 10 minutes

Note: Certain materials should not be tumble dried e.g. rubber, plastic or any material that would melt if heated. Please remove any detergent dispensers from the drum before drying the laundry. Do not dry unwashed items in the washer dryer.

AUTOMATIC FEATURES

KG Mode (Half Load)

Available on the Cottons and Synthetics cycles, the intelligent sensor adjusts the water level and programme length throughout each phase of the cycle according to how much laundry you load into the machine. The KG Mode indicator will light up when the intelligent sensor is weighing the laundry.

The washing machine is fitted with a self-adjusting water level system. This system enables the machine to use the optimum amount of water needed to wash and rinse the laundry in relation to the particular load. This results in a reduction of the water and electricity used without in any way compromising the washing and rinsing performance. The amount of water and electricity used will always be appropriate for the clothes load size.

The washing machine automatically ensures excellent washing results at minimum cost whilst respecting the environment.

Out of Balance protection

This model is fitted with an electronic sensor device that checks if the load is balanced correctly. If the load is slightly unbalanced the machine will re-balance it automatically and then carry out the normal spin. If, after several attempts, balance is not restored a reduced spin speed will be used. If loads are seriously unbalanced the spin stage will be cancelled. This helps limit vibration, reduce noise and improve the washing machine's reliability and life.

PROGRAMME DESCRIPTIONS

For handling the various types of fabric and their level of dirtiness in your laundry the washing machine has different programme groups according to type of wash, temperature, spin speed and duration (see Programme Guide).

Once the programme is selected, the intelligent sensor will weigh the laundry using the **KG Mode** and adjust the critical elements of the wash cycle depending on the weight of the laundry to ensure perfect results (available on Cotton and Synthetic cycle). The KG Mode is activated during the first 4 minutes of the cycle, which enables the machine to:

- adjust the amount of water required;
- determine the length of the wash cycle;
- control rinsing according to the fabric type selected;
- recognises if too much lather is present, adjusting the water level during rinsing if necessary;
- adjusts the spin speed according to the load, avoiding any imbalance

Cotton with Pre Wash

The Cotton programme is designed for maximum washing and rinsing efficiency. With spin cycles in between, the programme guarantees the laundry is rinsed perfectly. The final spin cycle ensures laundry is spun dry as much as possible up to the maximum speed.

The Cotton programme includes a Prewash cycle. This option is particularly useful for really dirty loads and can be used independently of the main wash programme. Additional detergent for the Prewash part of the programme should be added to the first compartment of the soap drawer labelled "1" (please refer to the section of this manual entitled "Detergent"). We recommend you use only 20% of the quantity used for the main wash programme.

Coloureds

This programme is also designed for maximum washing and rinsing efficiency. With spin cycles in between, the programme guarantees the laundry is rinsed perfectly. The final spin cycle ensures laundry is spun dry as much as possible up to the maximum speed. This cycle is set to 40°C, but the temperature may be altered using the Temperature option button.

"A" Wash 59'

This specially designed programme maintains the high quality wash performance identified with the "A" rating whilst greatly reducing the wash time. The programme is designed for a maximum load of 3 kg with a temperature of 60°C and concludes with 2 rinses and a high speed spin sequence.

Synthetics

Washing and rinsing performance is optimised through using drum rotation speeds and water levels suitable for synthetics and mixed fabrics. The programme will default to 40°C, but the temperature may be altered using the Temperature option button. The delicate spin action minimises creasing. The final spin speed for the synthetics programme is 800rpm

Delicate

The cycle will consist of alternate periods of activity and pauses. This is particularly suitable for washing very delicate fabrics, as it creates a hand-washing effect. Washing and rinsing are carried out using a high water level to provide the best results.

Wool

This is a programme dedicated to washing fabrics labelled with the Woolmark symbol . The cycle consists of alternate periods of activity and pauses. Washing and rinsing are carried out using a high water level to provide the best results. The programme has a maximum temperature of 40°C and concludes with 3 rinses, one for fabric conditioner, and a short spin at 800rpm.

Rinse

This programme carries out three rinses with an intermediate spin (which can be reduced or excluded by using the Spin Speed option). It can be used for rinsing any type of fabric e.g. use after hand washing.

Spin

The Spin programme completes the spin at the maximum spin speed, this can be reduced by using the Spin Speed option button.

Drain

This programme drains out the water from the machine.

Silk

This washing machine also has a gentle Silk and Hand Wash programme. This programme allows a complete washing cycle for garments specified as "Hand Wash Only" and laundry items made from silk or specified "Wash as Silk" on the fabric label.

The programme has a maximum temperature of 30°C and concludes with 3 rinses, one for fabric conditioner, and no final spin.

Rapid

The Rapid programme allows a washing cycle to be completed in just 14 minutes! This programme is particularly suited to slightly dirty cottons and mixed fabrics.

Using the Wash Time button on the Rapid cycle will enable you to select either a 14, 30 or 44 minute wash cycle.

When selecting the rapid programme, please note that we recommend you use only 20% of the recommended quantities shown on the detergent pack.

For information about these programmes please refer to the programmes table.

Sports

This washing machine has a unique Sportswear programme.

It is specially designed to wash mixed sportswear fabrics that cannot be washed on hotter programmes and is designed to remove the dirt and staining created by participation in sports activities.

This programme washes at a cool 30°C, rinses twice (one is for fabric conditioner) and spins at 800rpm for the best care of your really dirty, delicate garments.

High Dry

High temperature drying programme for Cottons and linen items, always refer to the care label

Low Dry

Low temperature drying programme for synthetics and mixed fibres, always refer to the care label.

Wash & Dry 59'

When you only have a few items to wash and dry in a hurry, this 59 minute cycle is the ideal time saver!

Suitable for a light 1.5kg load size (e.g. 4 shirts) or slightly dirty fabrics, this cycle will wash, rinse, spin and dry your garments in under an hour.

We recommend that you reduce the detergent dosage when using this programme to avoid wastage.

Refer to the programme guide (pg. 26)

Information for the test laboratories
(Ref. EN 50229 Standards)

Washing

Use the programme ** with the maximum wash time selected, maximum spin speed and a temperature of 60°C.

Programme recommended also for test with a lower temperature.

Drying

First drying with 5kg (the load consists of: pillowcases and hand-towels) selecting the cotton drying programme (HIGH DRY) store dry ().

Second drying with 3kg (the load consists of: 3 sheets and hand towels) selecting the cotton drying programme (HIGH DRY) 120 minutes (120').

PROGRAMME GUIDE

** Information for the test laboratories
(see page 25)

Programme		Fabric Type	Water Temp Recommended (C°)	Water Temp MAX (C°)	Spin Speed MAX (RPM)	Max Load Size (kg)	Max Dry Load (kg)
Cottons + Pre		Cottons, Colourfast and linen	60	90	1400	8	5
Coloureds **		Cottons, Non-fast Coloureds, mixed fabrics	40	60	1400	8	5
A 59'		Cottons, Colourfast and linen	60	60	1400	3	3
Synthetic		Mixed fabrics and synthetics	40	60	800	4	4
Delicate		Delicate fabrics	40	40	400	2.5	-
Wool		Machine washable wool	40	40	800	2	-
Rinse		-	-	-	800	-	-
Spin		-	-	-	1400	-	-
Drain		-	-	-	-	-	-
Silk		Silk and 'Hand Wash Only' garments	30	30	0	1.5	-
Rapid 1) 14'-30'-44'		Lightly dirty cottons and synthetics	30	30	800	1.5	1.5
			30	40	800	2.5	2.5
			30	40	800	3.5	3.5
Sports		Mixed fabrics	30	30	800	2.5	2.5
High Dry		Cottons	-	-	-	-	5
Low Dry		Synthetics	-	-	-	-	4
Wash & Dry 59'		Synthetics	30	30	800	1.5	1.5

1) Using the Wash Time button on the Rapid cycle will enable you to select either a 14, 30 or 44 minute wash cycle.

Length of Programme			Detergent			Automatic Drying Cycle		
Short	Med.	Long	2		1	High Heat	Low Heat	Not available
1:42	2:02	2:52	✓	✓	✓	✓		
2:04	2:24	3:14	✓	✓	-	✓		
0:59	-	-	✓	✓	-	✓		
1:19	1:29	1:39	✓	✓	-		✓	
1:06	-	-	✓	✓	-			✓
0:59	-	-	✓	✓	-			✓
0:35	-	-	-	✓	-		✓	
0:09	-	-	-	-	-	✓		
0:04	-	-	-	-	-			✓
0:56	-	-	✓	✓	-			✓
0:14	-	-	✓	✓	-		✓	
-	0:30	-	✓	✓	-		✓	
-	-	0:44	✓	✓	-		✓	
1:20	-	-	✓	✓	-		✓	
-	-	3:50	-	-	-			✓
-	-	2:50	-	-	-			✓
0:59			✓	✓	-			✓

DETERGENT

Only use detergents that are suitable for use in a washing machine. You will obtain the best results from your wash with the minimum use of chemical products, and the best care for your laundry if you take into consideration the level of dirtiness as well as the type of detergent to choose.

The amount of detergent to use depends on:

- **Water hardness**

Depending on the hardness of the water and the type of detergent used, it is possible to reduce the amount of detergent.

The softer the water supply, the less detergent is required.

- **The level of dirtiness**

It is possible to reduce the amount of detergent used depending on how dirty the laundry is.

Use less detergent for items that are not very dirty.

- **Amount of laundry**

It is possible to reduce the amount of detergent when washing only a small amount of laundry.

For smaller loads use less detergent.

The dosages shown on the packaging of detergents for washing delicates often already refer to a reduced wash size.

Always follow the dosage instructions on the detergent packaging.

Dispensing instructions

The detergent drawer is split into 3 compartments:

- The first, labelled "1", is for detergent utilised during Prewash.
- The second, labelled "2", is for detergent utilised during the main wash.
- The third, labelled  is for special additives such as fabric softeners, fragrances, starch, brighteners etc.

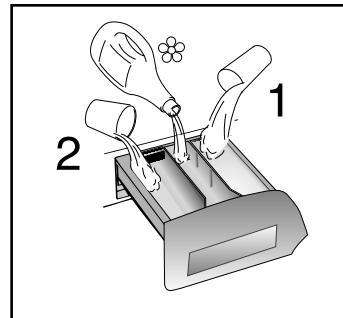

Dispensing in the drum

Liquid detergents and some tablets are dispensed via the machine drum using the recommended dispensing device which is placed upright on top of the wash load towards the back of the drum. Some tablets are designed to be placed in the dispenser drawer, check the detergent pack for details.

Do not put any items into the drawer other than detergents that are designed to be dispensed from the drawer as they may cause blockage or damage.

LAUNDRY

Items to avoid

We recommend that you do not wash underwired bras in the machine. Should the wires become detached they could cause damage to your clothes and the machine. If the wash care label states that the bra is machine washable then we advise placing it in a wash bag.

Recommendations

Always follow the wash care labelling on the garments.

Fasten zips, tie strings and close press-studs to prevent tangling. Ensure that pockets are emptied of loose change and other small items.

Unfold all items before placing them in the machine.

Check that there are no metal objects in the laundry as these may damage the laundry and the machine.

Place small items in a wash bag.

Divide the laundry according to the type of material (the symbol on the garment label) and colour, making sure that whites are separated from coloured garments

Do not exceed the values indicated in the "Programme Guide" which refers to the weight of the laundry items when they are dry.

WASHING ADVICE

The following tips are designed to assist in getting the best results from your machine whilst using it in the most environmentally friendly and economical way. It is also important to understand the items to avoid in your laundry, to ensure the continued safe and reliable operation of your machine.

Loading your washing machine

To make further reductions of energy, water and detergent consumption, we recommend that you put a full load into your machine. Energy savings of up to 50% can be achieved by washing one full load compared to two half loads.

Do not overload the machine as this will reduce the quality of the wash and may cause damage to the machine and your laundry.

When is prewashing really needed?

Only with particularly dirty loads! Energy savings of 5 to 15% are made by not selecting the prewash option for less dirty laundry. Pre-treat awkward stains with a washable stain remover.

Which wash temperature should you choose?

Using stain removers before machine washing reduces the need to wash at temperatures over 60°C.

Using a 40°C wash temperature can make energy savings of up to 50%.

Very dirty laundry

To ensure the best performance when washing a particularly dirty load, we recommend that you reduce the amount of items to be put into the machine. Allowing more space in the drum means the items can circulate more freely and will wash better.

Before using a drying programme...

SAVE energy and time by selecting a high spin speed to reduce the water content in laundry before using a drying programme.

RUNNING A WASH CYCLE

This section summarises the main points when completing a wash cycle. For detailed explanations of features, options and details of the machine refer to the relevant section in the instruction manual.

Preparing the laundry

Select and sort the laundry according to the wash care labels found on each garment.

Loading the laundry

Open the door. Put the laundry in the washing machine. Close the door by pushing it until it clicks, ensuring that no items of laundry are obstructing the lock or door seal.

Putting detergent in machine

Open the drawer, choose the detergent and put in the recommended amount.

Do not exceed the dosage stated below:

Compartment	Wash	Maximum quantity of powder/liquid
1	Prewash (option)	100 ml
2	Main Wash (all programmes)	200 ml
	Fabric Conditioner	200 ml

Close the drawer again.

Note: Liquid detergents and some concentrated powders and tablets that are to be placed directly into the drum should be placed in the recommended dispensing device.

Selecting the wash programme

Refer to the Programme Guide or the programme descriptions on the front of the machine to select the most suitable programme. Turning the programme selector and aligning the programme name with the indicator selects the programme. Check that the tap is turned on and that the discharge hose is positioned correctly. Select the required wash options.

Starting the wash cycle

Press the Start Pause button. The Door Locked indicator and KG Mode lights will illuminate.

After a few seconds the wash cycle will begin. During the first 4 minutes of

the wash cycle, the KG Mode will weigh the clothes and update the wash time remaining on the display every five seconds until the weight has been determined.

Do not try to open the door when the door locked indicator is on, nor open the dispenser drawer during the wash programme.

If you wish to pause the programme press the Start Pause button; after two minutes you will be able to open the door. To cancel the programme the programme selector should be turned to the OFF position. A new programme can be selected after cancelling the previous programme.

When the programme has finished

Wait approximately two minutes for the door lock to be released. When the door locked indicator light goes out it will then be safe to open the door.

Switch off the machine by turning the programme selector to the OFF position so that it will be ready the next time you use the machine (this action resets the memory in the machine). Open the door and remove the laundry. Disconnect the plug from the mains power supply and turn off the water supply whenever you finish using it.





DRYING ADVICE

In addition to the advice for washing your clothes, you should also follow the guidelines below when drying clothes.

Sort the load before drying

We recommend that you sort the laundry by the following methods:

- **By drying care symbols**, which are display on the clothing labels:

-  Suitable for tumble drying
-  Tumble dry at high temperature
-  Tumble dry at low temperature only
-  **DO NOT** tumble dry

If the fabric does not have a care label, it should be assumed it is not suitable for drying.

- **By size and thickness**

Whenever the wash load is bigger than the drying capacity, separate the clothes according to thickness (e.g. towels from thin underwear).

- **By fabric type**

Cottons/linen: Towels, cotton jersey, bed and table linen.

Synthetics: Blouses, shirts, overalls, etc. made of polyester or polyamide, as well as for cotton/synthetic mixes.

Items to avoid when drying

We recommend that you **DO NOT** dry the following items in the washer dryer:

- Woollens, silk, delicate fabrics, nylon stockings, delicate embroidery, fabrics with metallic decorations, garments with PVC or leather trimmings, trainers / sports shoes, bulky items such as sleeping bags, etc, should not be tumble dried.
- Do not dry articles that have been treated with a dry cleaning fluid or rubber clothes, as there is a danger of fire or explosion.
- Foam rubber materials should not be placed in the dryer. In certain circumstances e.g. when heated, these materials could spontaneously combust, setting fire to your machine. Foam rubber, foam plastic and rubber-like materials are not suitable for tumble drying.
- Do not dry items that are dripping wet. It is advisable to spin dry garments before the drying stage.

RUNNING A DRY CYCLE

This section summarises the main points when completing a drying cycle. For detailed explanations of drying programmes, please refer to the relevant section in this manual.

Sorting the laundry

Once the wash cycle has finished, make sure the laundry does not exceed the recommended drying weight (see Programme Guide for details). If you have filled the washing machine to the maximum level you will need to remove some of the laundry before starting the drying stage. It is advisable to reduce the load size further if the item is bulky or absorbent e.g. towels. Please refer to the Drying Advice section for a list of items that should not be tumble dried.

Selecting the drying programme

Refer to the Programme Guide to choose the most appropriate drying cycle for your laundry, with the correct heat setting for the fabrics type (high heat for cottons, low heat for synthetics). Turn the programme dial to the appropriate heat setting. Press the Drying Selection button until the required programme is selected (refer to the Dry Options table).

Starting the drying cycle

Once the programme option is illuminated, press the Start Pause button to begin the cycle. The Door Locked indicator and KG Mode lights will illuminate. After a few seconds the cycle will begin, highlighting the time remaining for the cycle based on a full dry load. During the cycle the appliance will assess the load then update the time to suit the actual load size and dampness of the fabrics. The double glazed door of this appliance provides protection against the high heat created by the tumble drying action.



When the programme has finished

We recommend that you let the Cool Down period of the drying cycle complete before removing the laundry, as the laundry would be too hot to handle without this phase. Once the drying cycle has finished, the word END will be displayed on the digital display. Wait 2 minutes until the Door Locked indicator turns off. Open the door and remove the laundry. Turn the programme dial to the OFF position.

Selecting a straight through wash & dry cycle

If you wish to wash and dry a load without stopping in between wash and dry cycles, make sure the wash load does not exceed the maximum dry weight (see Programme Guide for details). Once the detergent has been added and the wash programme and options selected, you should then choose the drying cycle before pressing the Start Pause button. The appropriate heat setting is automatically selected (see Programme Guide for details).

Estimated drying times of Sensor Dry programmes

Programme	Cottons		Synthetics / Acrylics	
	Min 1 kg	Max 5 kg	Min 1 kg	Max 4 kg
Extra Dry 	From 30 mins	Up to 230 mins	From 30 mins	Up to 170 mins
Store Dry 	From 30 mins	Up to 220 mins	From 30 mins	Up to 150 mins
Iron Dry 	From 30 mins	Up to 170 mins	From 30 mins	Up to 80 mins

The time remaining shown on the digital display will show the time remaining for a full load. However, this will be corrected during the cycle once the appliance assesses the weight and dampness of the laundry.

CARE AND MAINTENANCE

The washing machine needs very little maintenance, but regular attention to a few small details will ensure the continued performance of your washing machine.

Do not use abrasive cleaners, scouring pads, solvent-based cleaners or polishes; wiping the outside of the machine with a damp cloth will suffice.

Cleaning the soap dispenser

It is advisable to clean the compartments occasionally to remove detergents and additives. To do this you need to do the following:

- Step 1.** Pull the drawer out firmly from the machine, but without forcing it.
- Step 2.** Clean the compartments and the siphon cover under warm running water.
- Step 3.** Clean the outlet of the soap dispenser to remove any residue of soap powder.
- Step 4.** Replace the drawer.

Cleaning the door glass

Regularly clean the door glass with a damp cloth. A build up of soiling and residues from the water may result in water leaking from the door.

Do not use abrasive cleaners as they can scratch the surface.

Cleaning the filter

The washing machine is fitted with a special filter to prevent items such as coins, buttons, etc. blocking the discharge hose. These may be retrieved by:

- Step 1.** Opening the filter cover.
- Step 2.** Pull out the corrugated hose (only available on certain models), remove the stopper and drain the water into a container.
- Step 3.** Before removing the filter, place an absorbent towel below the filter cap to collect the small amount of water that is likely to be inside the pump.

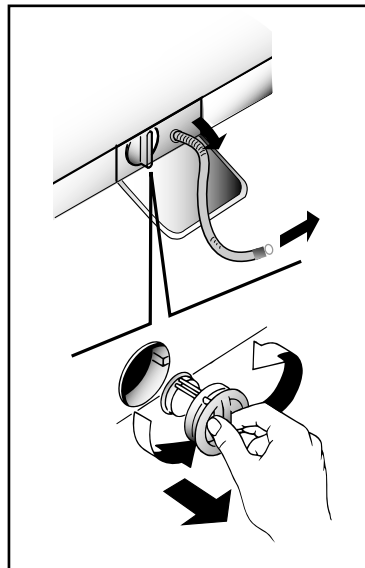

Step 4. Turn the filter anti-clockwise until it stops in the vertical position. Remove the filter and clean.

Step 5. Replace the filter and turn in a clockwise direction until locked in position. Replace the stopper in the hose and close the filter cover.

We recommend that the filter be cleaned frequently, at least once a month.

Maintenance wash

Using small quantities of detergent and low temperature wash programmes can cause the gradual build up of grease, dirt and scale. Over time these deposits can damage your laundry and your machine. They can also cause your machine to smell. We recommend that you carry out a maintenance wash a couple of times per year to keep your machine and pipe work clean and free of these deposits. Simply run the Cottons 90°C programme without a load and with the normal quantity of detergent.

PROBLEM SOLVING GUIDE

Defects you can remedy yourself

Before calling Hoover Service for technical advice please run through the following checklist. A charge will be made if the machine is found to be working or has been installed incorrectly or used incorrectly. If the problem persists after completing the recommended checks, please call Hoover Service (tel: 08705 400 600); they may be able to assist you over the telephone.

Advisory note

During drying phase the drum will accelerate to a higher speed to distribute the load and to optimize the drying performance

The machine will not start...

- Close the door. Check that there is power to the machine. Select a programme and press Start Pause. Check if the door locked light is illuminated.

If it is not, check the following:

1. Is the machine connected to the electrical supply?
 2. Is the electrical supply OK? Check another socket.
 3. Has the fuse on the machine blown? If so, replace it.
- If the door locked light is illuminated and the machine does not start this means that the machine cannot fill with water, check the following:
 1. Check the programme dial is correctly aligned with the programme.
 2. Is the water supply to the machine switched on?
 3. Are the pipes kinked or restricted in any way?

Water does not drain away... (error 3 will be displayed)

- Ensure that there is not a blockage in the drain hose or the hose is not kinked.
- Is the drain hose installed correctly? If connected to the sink waste make sure you have cut the membrane or removed the bung from the under sink drainage unit.
- Check for foreign bodies in the filter. If present, clean the filter.
- If you have found any of the above problems correct them and run the machine through a spin cycle to drain the water.

Water on the floor around the washing machine...

- Is the fill hose tightened? If so, replace the rubber washers and re-tighten.
- Is the standpipe or the household drain blocked? If so, clear the blockage yourself or call a plumber.
- Is there clothing or dirt between the door gasket and the door glass? Ensure that the door glass and gasket are kept clean and free of laundry when loading the machine.

The machine does not spin...

- Water has not drained from the machine? Check the points highlighted above.
- Have you selected an option that changes the spin profile (change of spin speed on the selector)? Check the feature in the description of the controls.
- Is the load unbalanced? To reduce noise and vibration and improve the machine's reliability and life, the machine is fitted with an electronic sensor that detects if the load is unbalanced. To improve the spin performance the load can be re-distributed by hand at the end of the cycle and then re-spin.

The machine is noisy or vibrates a lot during the cycle...

- Has the transit system been fully removed? (see Unpacking the Product).
- Are there any loose items in the pockets of clothing that can rattle in the drum and cause damage?
- Is the load unbalanced? Stop the programme, redistribute the load and restart.

The programme takes a long time...

- Some programmes do take a long time (over 2.5 hours). Low water pressure can increase the length of the programme.

The door will not open...

- Has the programme finished? Is the END light illuminated? If not the programme is not complete. Has the door locked light gone out? If not wait a further two minutes and the light will go out and you will be able to open the door.
- Has the programme finished but the door remains locked? The display reads Error 2. Turn the machine to OFF to reset the machine and this will allow the door to open.
- If water remains in the drum refer to 'Water does not drain away...' above.

Problem with the dispenser...

- Not all the detergent has been flushed away.
 1. Check the water supply tap is fully turned on.
 2. Check the inlet hose is not kinked.
- The dispenser drawer will not close properly.
 1. Check the drawer is aligned properly
 2. Check the drawer is not clogged with detergent (see Care and Maintenance)
- Steam is coming from the dispenser. The machine is designed to vent through the drawer, this is nothing to worry about.

The clothes load is not dry...

- Was sufficient time or automatic setting selected to dry the clothes load? (Refer to Drying Time Guide page 35.)
- Is the wash programme selected followed automatically by a drying programme? (Refer to Programme Guide page 26.)
- Was the laundry correctly spun prior to drying? Select a spin programme to remove the excess water.
- Has the correct drying programme been selected? Refer to the laundry care label for guidance.
- The laundry may have been excessively wet at the end of the wash cycle eg. The load was out of balance (see page 22). In this case the load may not have dried within the maximum time allowed. Select a drying only programme (page 25) to complete the drying.

Remember, you may be charged for the service call if incorrect installation or misuse causes a problem with your machine.

If the following error codes are displayed, switch OFF the machine and contact Hoover Service: 0, 1, 4, 5, 7, 8 and 9.

Note: The use of environmentally friendly, phosphate-free detergents (check detergent information on pack) can have the following effects:

- Waste water from rinsing may be cloudier because of the presence of a white powder (zeolites) held in suspension, without the rinse performance being adversely affected.
- Presence of white powder on laundry after washing, which is not absorbed by the fabric and does not alter the colour of the fabric.
- The presence of foam in the final rinsing water is not necessarily an indication of poor rinsing. Carrying out more rinse cycles does not serve any purpose in such cases.

Power Failure

If there is a power failure the wash cycle will be interrupted, and the wash programme and functions will be suspended. When the power is restored, the wash programme and functions will re-start from the same point and complete the programme.

During a power failure the water can be drained and the load can be removed from the machine as follows:

Step 1. Switch off the machine both via the programme dial and the mains power supply. Remove the plug from the mains power supply socket.

Step 2. Carefully move the machine so the rear of the machine is accessible. Please follow the safety precautions that we recommend under the Warning and Safety Instructions section of this manual.

Step 3. Unclip the drain hose from the rear panel of the machine and lower the hose into a bowl on the floor. When the bowl is full raise the end of the drainpipe to a height higher than the top of the appliance to stop the flow of water. Empty and replace the bowl and continue draining the machine until empty.

Step 4. Once the machine is fully drained of water, clip the hose to the rear of the machine. Open the door and remove the load.

The door can be opened approximately 2 minutes after the power failure.

Do not force open the door.

Further Problem Solving advice can be found on the After Sales Service pages of our website www.hoover.co.uk

AFTER SALES SERVICE

Customer Service

At Hoover, we aim to make appliances that are reliable and long lasting. However, should your appliance need to be serviced during its working life, no one is more qualified to maintain your appliance than our own Hoover Service engineers. To book a service call or to ask our customer service advisors for help on using your appliance, please call:

08705 400 600

or contact us online

www.hoover.co.uk

Please have your model and serial numbers at hand when calling our service department, as they will require this information.

(Telephone lines open: Monday to Friday 8.30am to 5pm, Saturday 9am to 5pm, Sunday 10am to 4pm). We may record your phone calls with our representatives to monitor and improve the quality of service we provide.

Guarantee

Your new Hoover appliance automatically comes with a 12-month call out, parts and labour guarantee.

Register your appliance now by calling

08444 810 157

or register online

www.hoover.co.uk

Providing that you register your purchase, Hoover guarantees all parts of this product for 5 years from the date of purchase. During the first year Hoover approved engineers will replace or repair all defective parts free of charge, except for parts subject to fair wear and tear, such as interior lamps.

In years 2-5 replacement parts will be supplied free only if fitted in the UK or Republic of Ireland by Hoover and the appropriate labour charges paid. An extended warranty may be purchased to also cover the labour costs. Please ask our customer service advisors for cost details or complete the enclosed form.

To qualify for benefits under the guarantee, you must be able to provide proof of date of purchase and the appliance must have been supplied, maintained and used in accordance with Hoover instructions.

The guarantee excludes:

- Any faults which occur due to bad installation or misuse of the machine.
- Repair of, or interference with, the machine by any person not authorised by the manufacturer.
- Any parts which are fitted to the machine that are not original manufacturer's parts.
- Non-domestic use of the machine.
- Operation at incorrect voltage.
- The result of using this machine for any purpose other than those described in the instruction book.

Spares and Accessories

If any part of your appliances needs replacing during its lifetime, please make sure that you replace them with genuine Hoover spare parts by calling:

01204 556 111

or online

www.hoover.co.uk

A number of accessories can also be purchased using the above contact details.

Brochures

At Hoover, we produce a range of home appliances including vacuum cleaners, cooling appliances, washing machines, tumble dryers, dishwashers, cookers and built-in appliances.

If you would like a brochure for any of our product ranges please call our head office on:

01685 721222

or view our full range online

www.hoover.co.uk

Our customer service advisors will be able to advise you of any matching appliance, or appropriate replacement product when it is time to replace your purchase.

HOOVER®

Note: Hoover policy is one of continuous development and accordingly we reserve the right to alter specification without notice. The manufacturer declines all responsibility for errors printed in this instruction manual.

Hoover Ltd. Pentrebach, Merthyr Tydfil, Mid Glamorgan, CF48 4TU



11.02 - 41033712.S - www.graficaestampa.it - Printed in Italy - Imprimé en Italie