

HOOVER

RUSH

INSTRUCTION MANUAL



GENERATION FUTURE

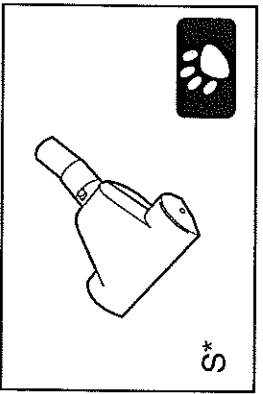
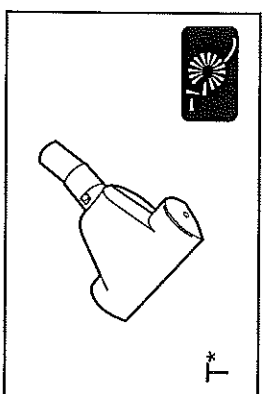
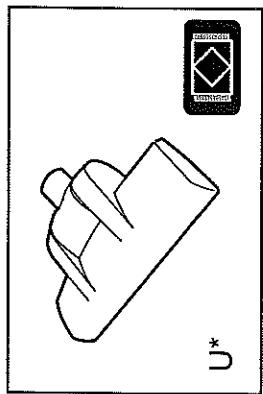
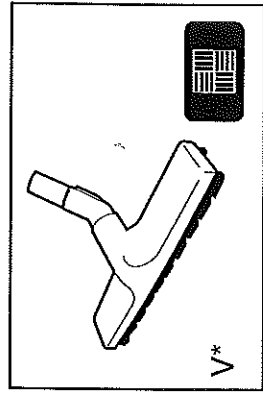
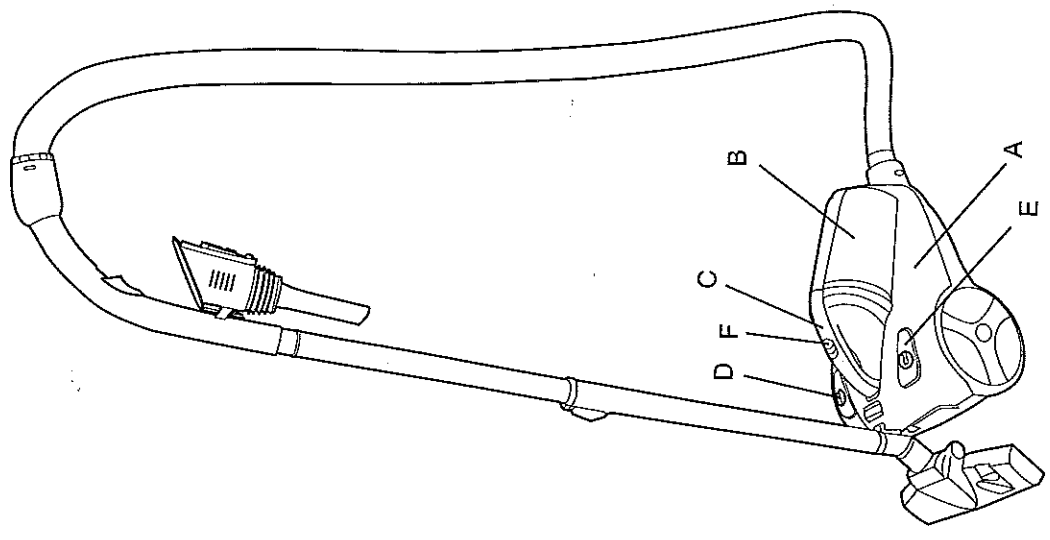
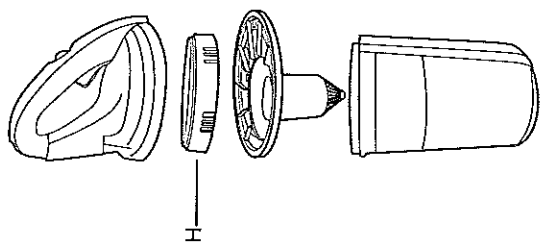
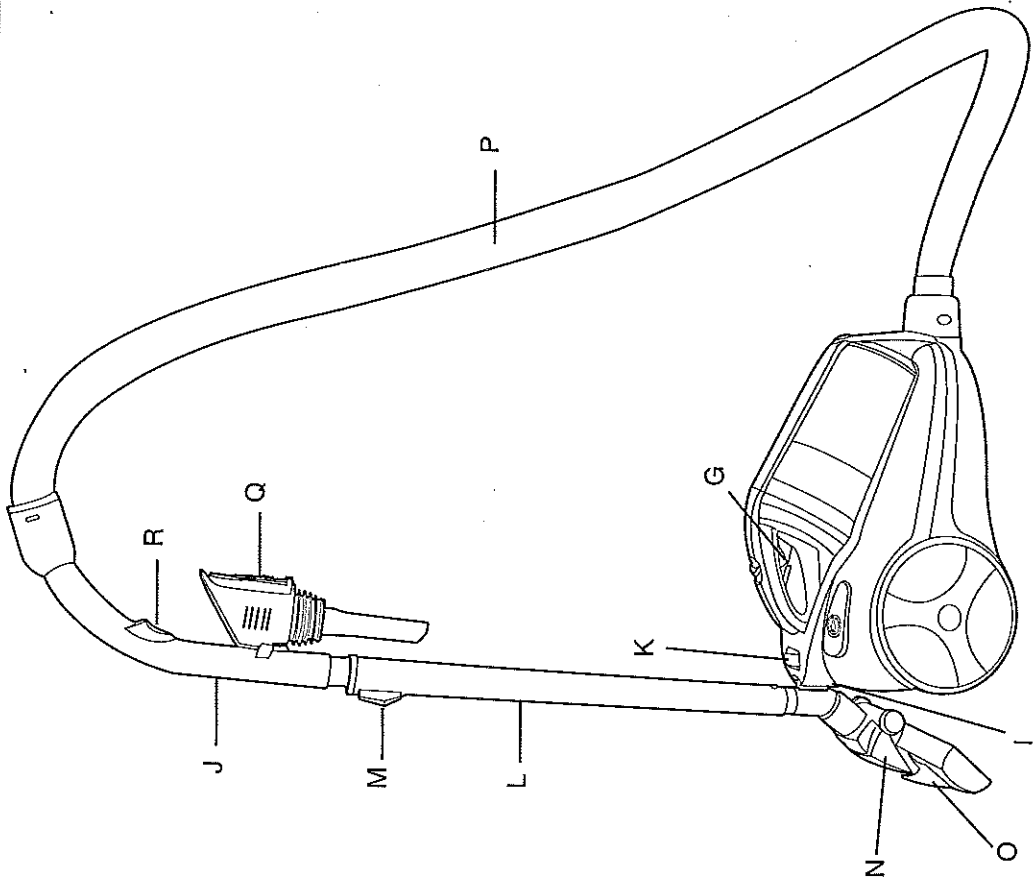

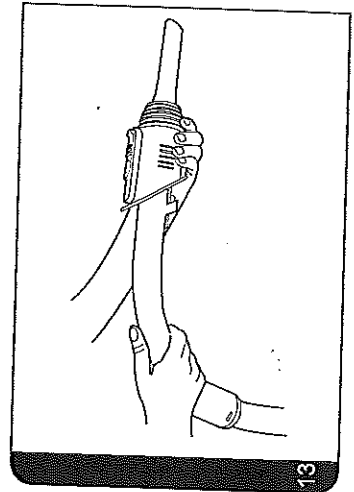
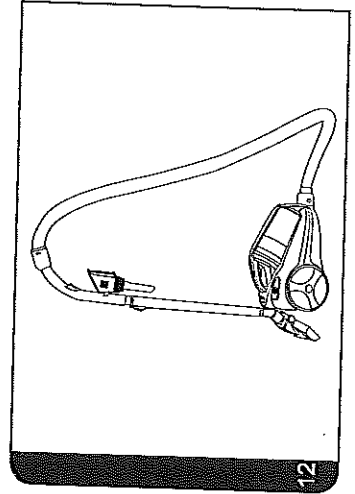
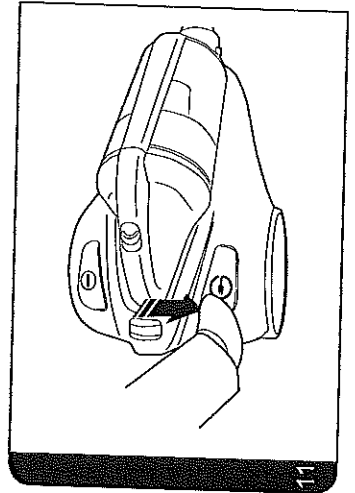
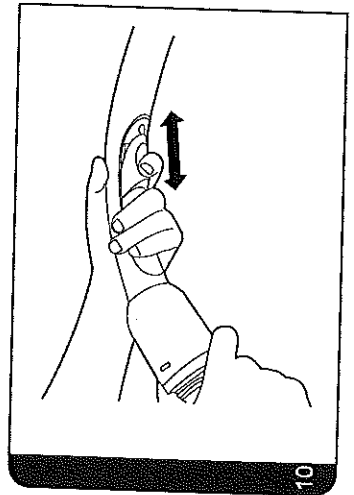
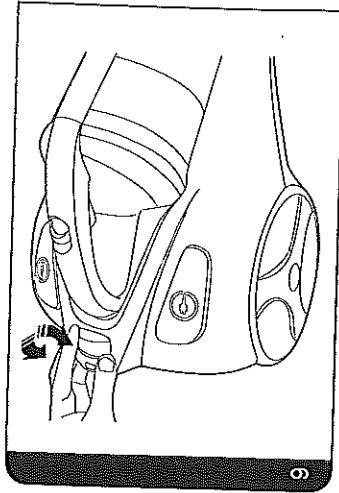
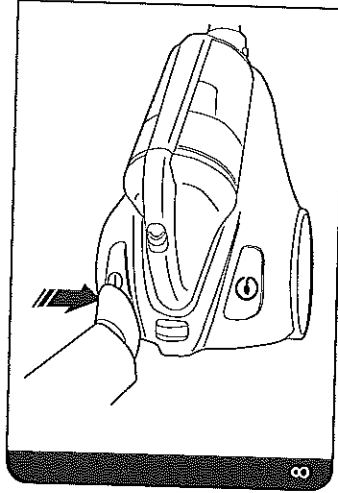
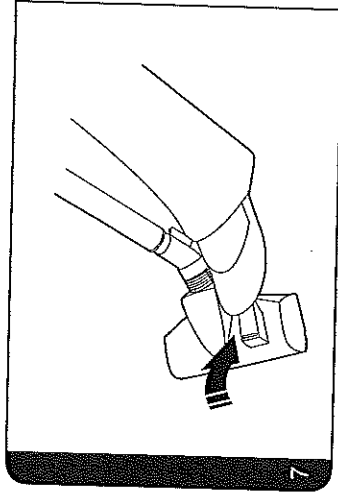
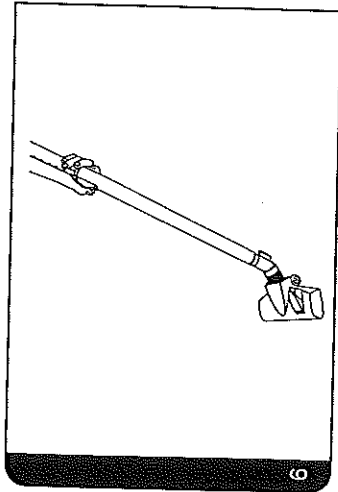
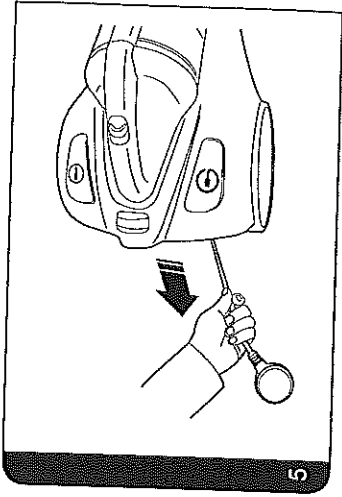
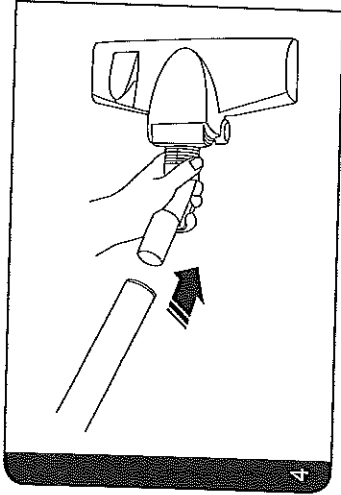
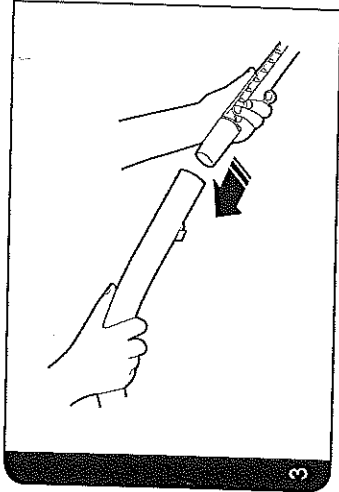
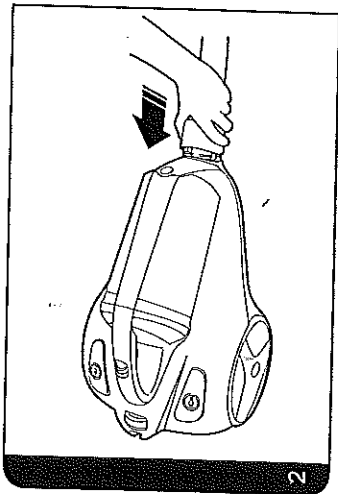

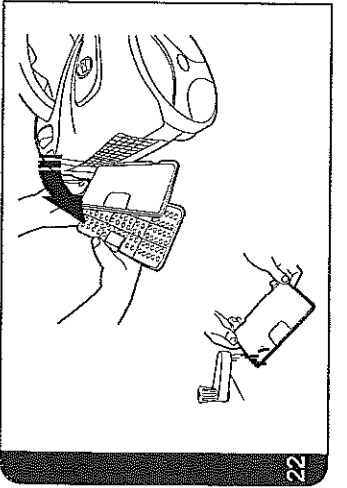
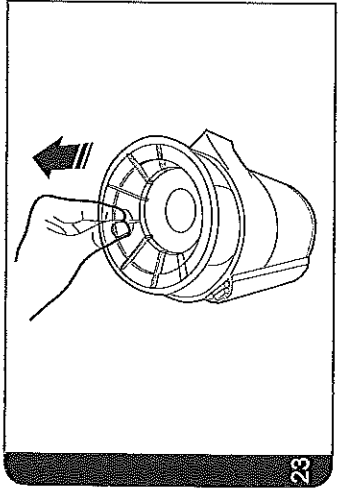
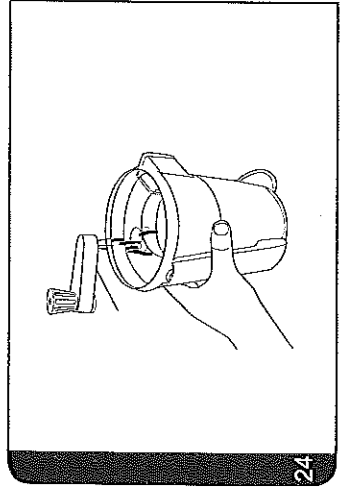
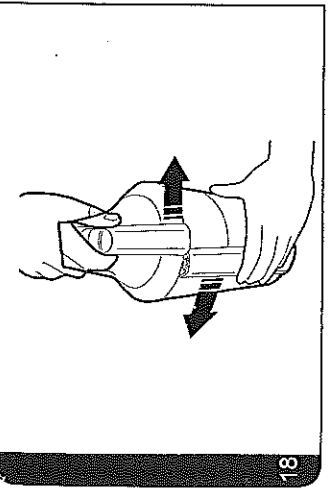
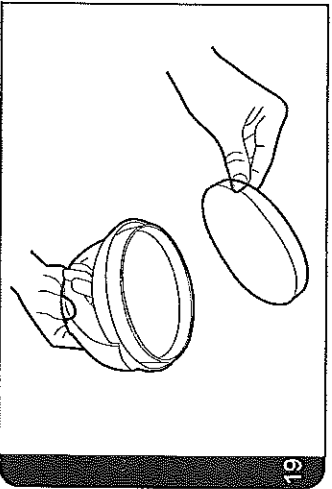
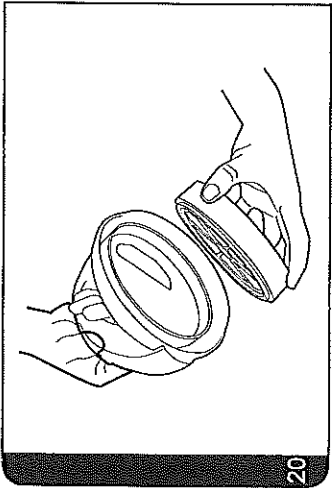
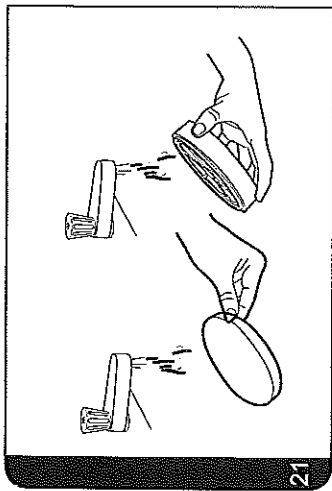
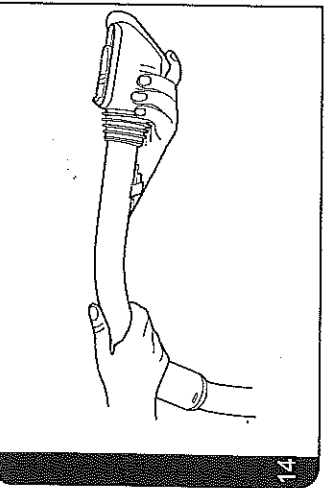
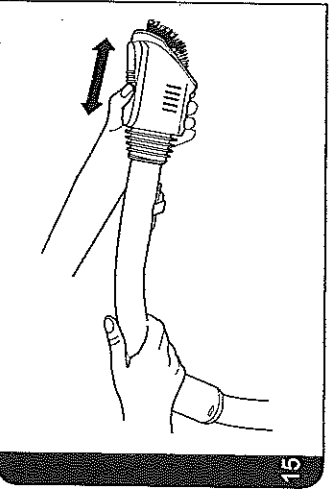
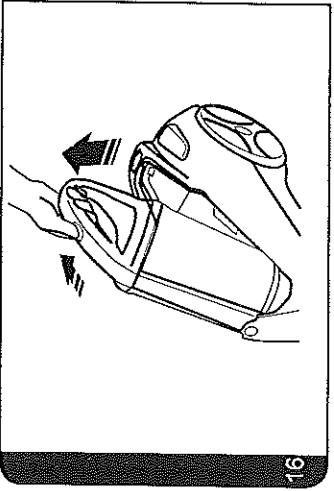
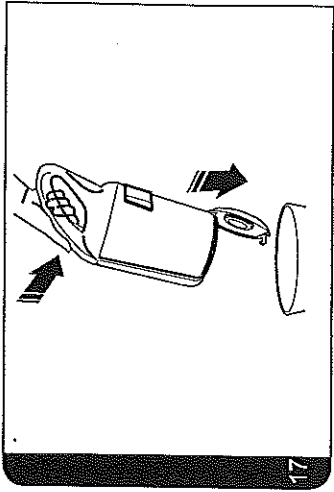

IMPORTANT SAFETY REMINDERS

This cleaner should only be used for domestic cleaning, as described in this user guide. Please ensure that this guide is fully understood before operating the appliance. Use only attachments recommended or supplied by Hoover.

WARNING: Electricity can be extremely dangerous. This appliance is double insulated and must not be earthed. This plug is fitted with a 13 amp fuse (UK only).

IMPORTANT: The wires in the mains power lead are coloured in accordance with the following code:

Blue – Neutral **Brown** – Live

STATIC ELECTRICITY: Some carpets can cause a small build up of static electricity. Any static discharge is not hazardous to health.

AFTER USE: Switch the cleaner off and remove the plug from the electricity supply. Always switch off and remove the plug before cleaning the appliance or attempting any maintenance task.

SAFETY WITH CHILDREN, ELDERLY OR THE INFIRM: Do not let children play with the appliance or its controls. Please supervise the use of the appliance by older children, the elderly or the infirm."

HOOVER SERVICE: To ensure the continued safe and efficient operation of this appliance we recommend that any servicing or repairs are only carried out by an authorised Hoover service engineer.

IT IS IMPORTANT THAT YOU DO NOT

- Position the cleaner above you when cleaning the stairs.
- Use your cleaner out of doors or on any wet surface or for wet pick up.
- Pick up hard or sharp objects, matches, hot ashes, cigarette ends or other similar items.
- Spray with or pick up flammable liquids, cleaning fluids, aerosols or their vapours as this may cause risk of fire / explosion.
- Run over the supply cord when using your cleaner or remove the plug by pulling on the supply cord.
- Stand on or wrap the power cord around arms or legs when using the cleaner.
- Use the appliance to clean people or animals.
- Continue to use your cleaner if it appears to be faulty. If the supply cord is damaged stop using the cleaner IMMEDIATELY. To avoid a safety hazard, an authorised Hoover service engineer must replace the supply cord.

GETTING TO KNOW YOUR CLEANER

- A. Cleaner main body
- B. Dust Container
- C. Dust Container handle
- D. On/Off Button
- E. Cord Rewind Button
- F. Dust Container Release Button
- G. Dust Container Door Release Trigger
- H. HEPA/ Foam Filter Pack
- I. Park slot
- J. Handle
- K. Power Control Regulator
- L. Telescopic Tube
- M. Telescopic tube adjuster
- N. Carpet & Floor Nozzle
- O. Carpet Care Control Selector
- P. Hose
- Q. 3 in 1 Tool:
 - Qa. Crevice Tool
 - Qb. Furniture Nozzle
 - Qc. Dusting Brush
- R. Suction Regulator
- S. Pet Hair Remover Mini Turbo Nozzle*
- T. Allergen Remover Mini Turbo Nozzle*
- U. Grand Turbo Nozzle*
- V. Parquet Caresse Nozzle*

(*Certain Models Only)

ASSEMBLING YOUR CLEANER

Remove all components from the packaging.

1. Connect the hose to the cleaner main body, ensuring it clips and locks into position. To release: simply press the two buttons on the hose end and pull. [2]
2. Connect the tube upper end to the handle, and store the 3in1 tool underneath the handle. [3]
3. Connect the tube lower end to the carpet and floor nozzle. [4]

USING YOUR CLEANER

1. Extract power cord and plug it into the power supply. Do not pull the cord beyond the red marker. [5]
2. Adjust the telescopic tube to the desired height by moving the telescopic release button up and raise or lower the handle to the most comfortable cleaning position. [6]
3. Select carpet care control height by pressing the pedal in the nozzle. [7]
Hard Floor – Brushes are lowered to protect the floor.
Carpet – Brushes are raised for the deepest clean.
4. Switch the cleaner on by pressing the On/Off Button on the cleaner main body. [8]
5. Adjust the power control regulator to the desired level. [10]
6. Adjust the suction regulator to the desired level. [10]
7. Switch off at the end of use by pressing the On/Off Button. Unplug and press the cord rewind button to wind the power cord back into the cleaner. [11]
8. To store your cleaner adjust telescopic tube to the lowest height setting and park the nozzle in the park position on the cleaner main body. [12]

ACCESSORIES

Please see the model specification on the packaging label for inclusion of accessories to individual models. All accessories can be purchased separately from Hoover. (See Hoover Spares and Consumable section).

All accessories can be fitted to the end of the hose or the end of the telescopic tube.

3 in 1 tool – Combines several functions in one. The 3 in 1 tool can be stored neatly underneath the hose handle.

Crevice Tool – For corners and hard to reach areas. [13]

Furniture Nozzle – For soft furniture and fabrics [14]

Dusting Brush – For bookshelves, frames, keyboards and other delicate areas. To extend the brushes push the button on the body of the tool. [15]

Parquet Caresse Nozzle* – For parquet floors and other delicate floors.

Grand Turbo Nozzle* – Use the turbo nozzle for deep cleaning on carpets.

Pet Hair Remover Mini Turbo Nozzle* – Use the mini turbo nozzle on stairs or for deepcleaning on textile surfaces and other hard to clean areas. Particularly suitable for pet hairs removal.

Allergen Remover Mini Turbo Nozzle* – Use the mini turbo nozzle on stairs or for deepcleaning on textile surfaces and other hard to clean areas. Particularly suitable for allergen removal.

IMPORTANT: Do not use the turbo and mini turbo nozzles on rugs with long fringes, animal hides and carpet pile deeper than 15mm. Do not keep the nozzle stationary while the brush is rotating.

(*Certain Models Only)

CLEANER MAINTENANCE

Emptying the Dust Container

When the dust reaches the max level indicator in the container empty the dust container. **IMPORTANT:** To maintain optimum performance do not allow the dust to sit higher than the max level.

1. Release the container by sliding the bin release button towards the rear of the cleaner. [16] Lift the dust container from the cleaner main body.
2. Hold the dust container over a bin with one hand and press the bin container door open trigger. [17]
3. Close the dust container door and refit to the cleaner main body.

Cleaning the washable filters

The cleaner is fitted with a blue hepa filter pack. To maintain optimum cleaning performance regularly remove the the filters and tap against the side of the bin to release dust. The filters should be washed every 3 months or when the filter has excessive dust level.

IMPORTANT: Regularly check and maintain the filters.

IMPORTANT: Always ensure the filter pack is fully dry before use.

To access the filter:

1. Release the container by sliding the bin release button towards the rear of the cleaner. [16] Lift the dust container from the cleaner main body.
2. Hold the bin with one hand and with the other hand rotate the bin handle anti clockwise to release from the bin container. [18]
3. Remove the foam filter from the hepa filter unit located in the bin handle. [19]
4. Remove the hepa filter unit from the bin handle. [20]
5. Gently tap and wash the grey foam filter using warm water. Do not use hot water or detergents. Remove excess water from the filter and leave to dry fully before re-using. [21]
6. Gently tap and wash the Blue HEPA filter unit. Do not use hot water or detergents. [21]
7. Reassemble to filter pack once fully dry and refit to the cleaner.

IMPORTANT: Do not use the product without the filter pack fitted.

To access the exhaust filter:

1. Unclip the exhaust filter from the rear of the cleaner. [22]
2. Gently tap and wash the grey foam filter using warm water. Do not use hot water or detergents. Remove excess water from the filter and leave to dry fully before re-using. [22]

IMPORTANT INFORMATION

Hoover spares and Consumables

Always replace parts with genuine Hoover spares. These are available from your local Hoover dealer or direct from Hoover. When ordering parts always quote your model number:

- Filter Kit: Pre-Motor Hepa Filter + Exhaust Filter: U60 - 35600936
- Carpet and Floor Nozzle: G98 - 35600878
- Parquet Carette Nozzle: G90PCB - 35600934
- Mini Turbo Nozzle Pet Hair Remover: J40P - 35600937
- Flexible Hose: D109 - 35600939
- Hose Handle: DH11 - 35600940

Hoover Service

Should you require service at any time, please contact your local Hoover Service Office.

Quality and the Environment

Quality

Hoover's factories have been independently assessed for quality. Our products are made using a quality system which meets the requirements of ISO 9001

The Environment:

This appliance is marked according to the European Directive 2002/96/EC on Waste Electrical and Electronic Equipment (WEEE). By ensuring this product is disposed of correctly you will help prevent potential negative consequences for the environment and human health, which could otherwise be caused by inappropriate waste handling of this product.

The symbol on the product indicates that this product may not be treated as household waste. Instead it shall be handed over to the appliance collection point for recycling of electrical and electronic equipment. Disposal must be carried out in accordance with the local environmental regulations for waste disposal. For more detailed information about treatment, recovery and recycling of this product, please contact your local city office, your household waste disposal service or the shop where you purchased the product.

Your Guarantee

The guarantee conditions for this appliance are as defined by our representative in the country in which it is sold. Details regarding these conditions can be obtained from the dealer from whom the appliance was purchased. The bill of sale or receipt must be produced when making any claim under the terms of this guarantee. Subject to change without notice.

Cleaning the separation unit

This cleaner uses the separation system, unique to Hoover. If necessary the separation unit can be disassembled from the dust container and cleaned.

1. Release the container by sliding the bin release button towards the rear of the cleaner. [16] Lift the dust container from the cleaner main body.
2. Hold the bin with one hand and with the other hand rotate the bin handle anti clockwise to release from the bin container. [18]
3. Remove the red vortex finder from the dust container by pulling the tab provided. [23]
4. Use a cloth to remove excessive dust from the red vortex finder surface.
5. Place the bin under the Tap as shown [24] Rinse with luke warm water. Wash internal surfaces of the bin with water only. DO NOT use soap detergents to wash the internals of the bin.
6. Reassemble the red internal component to the bin.
7. Reassemble the bin handle to the bin container. Refit the dustbin to the cleaner.

Removing a blockage

1. Check if the dust container is full. If so refer to 'Emptying the dust container.'
2. If the dust container is empty but suction is still low:
 - A. Do the filters need cleaning? If so refer to 'Cleaning the washable filters'.
 - B. Check if there is any other blockage in the system - Use a rod or pole to remove any blockage from the extension tube or flexible hose.
 - C. Check if pre-motor filter is fitted.
 - D. Check if the separation unit needs to be cleaned. Refer to 'Cleaning the separation unit'

USER CHECKLIST

Should you have a problem with the product, complete this simple user checklist before calling your local Hoover service.

- Is there a working electricity supply to the cleaner? Please check with another electrical appliance.
- Is the dust container over-filled? Please refer to 'Cleaner Maintenance'.
- Is the filter blocked? Please refer to 'Cleaner Maintenance'.
- Is the hose or nozzle blocked? Please refer to 'Removing a blockage from the system'.
- Has the cleaner overheated? If so, it will take approximately 30 minutes to automatically reset.



GENERATION FUTURE

PRINTED IN P.R.C.
48000513