

**HOOVER**



**OVENS  
USER INSTRUCTIONS**

- HDO 889**
- HDO 885**

## General warnings

Thank you for choosing one of our products. To get the most out of your oven we recommend that you:

Read the notes in this manual carefully: they contain important instructions on how to install, use and service this oven safely.

Keep this booklet in a safe place for easy, future reference.

When the oven is first switched on it may give out acrid smelling fumes. This is because the bonding agent for insulating panels around the oven has been heated up for the first time. This is a completely normal, if it does occur you merely have to wait for the fumes to clear before putting the food into the oven.

An oven by its very nature becomes very hot. Especially the glass of the oven door. Do not allow children to go near the oven when it is hot, especially when the grill is on. A specially designed protector shield (some models only) which reduces considerably the surface temperature of the oven door can be obtained through our service organization. This shield is recommended for households with young children.

**Declaration of compliance.** The parts of this appliance that may come into contact with foodstuffs comply with the provisions of **EEC Directive 89/109**.

**CE** This appliances complies with Directives 89/336/EEC, 73/23/EEC and following changes.

When you have unpacked the oven, make sure that it has not been damaged in any way. If you have any doubts at all, do not use it: contact a professionally qualified person. Keep packing materials such as plastic bags, polystyrene, or nails out of the reach of children because they are dangerous for children.

### IMPORTANT

The oven must be used only for the purpose for which it was designed: it must only be used for cooking food.

Any other use, e.g. as a form of heating, is an improper use of the oven and is therefore dangerous. The manufacturers cannot be held responsible for any damage caused by improper, incorrect or unreasonable use.

#### **When using any electrical appliance you must follow a few basic rules.**

- Do not pull on the power cable to remove the plug from the socket.
- Do not touch the oven with wet or damp hands or feet.
- Do not use the oven unless you are wearing something on your feet.
- Do not allow children or irresponsible people to use the oven unless they are carefully supervised.
- It is not generally a good idea to use adapters, multiple sockets for several plugs and cable extensions.
- If the oven breaks down or develops a fault switch it off at the mains and do not touch it. If the cable is at all damaged it must be replaced promptly. When replacing the cable, follow these instructions.

Remove the power cable and replace it with one of equal length that has been insulated in rubber. The cable must be able to bear the electrical current required by the oven. Cable replacement must be carried out by properly qualified technicians.

The earthing cable (yellow-green) must be 10 mm longer than the power cable. Use only an approved service centre for repairs and ensure that only original parts are used. If the above instructions are not adhered to the manufacturers cannot guarantee the safety of the oven.

## USEFUL TIPS

### Grilling

Grilling makes it possible to give food a rich brown colour quickly.

For browning we recommend that you insert the grill onto the fourth level, depending in the proportions of the food (pag.8).

Almost all food can be cooked under the grill except for very lean game and meat rolls. Meat and fish that are going to be grilled should first be lightly doused with oil.

### Cooking times

For recommended cooking times and temperatures the first time you use the oven, refer to the tables on pages 14,15,16, and 17 You may then wish to vary these times and settings in the light of your own experience.

### Cleaning and maintenance

Clean the stainless steel and enamelled surfaces with warm, soapy water or with suitable brand products. On no account use abrasive powders that may damage surfaces and ruin the oven's appearance. It is very important to clean the oven each time that it is used. Melted fat is deposited on the sides of the oven during cooking. The next time the oven is used this fat could cause unpleasant odours and might even jeopardise the success of the cooking. Use hot water and detergent to clean; rinse out thoroughly. To make this chore unnecessary all models can be lined with catalytic self-cleaning panels: these are supplied as an optional extra (see the section SELF-CLEANING OVEN WITH CATALYTIC LINING).

Use detergents and abrasive metal pads like «brillo pads» for the stainless steel grills. The glass surfaces as the top, oven door and warming compartment door must be cleaned when they are cold. Damage that occurs to them because this rule was not adhered to are not covered by the guarantee.

To replace the interior light: switch off the mains power supply and unscrew bulb. Replace with an identical bulb that can withstand very high temperatures.

### Self-cleaning oven with catalytic

Special self-cleaning panels covered in a micro-porous coating are available as optional extras for all models. If they are fitted, the oven no longer needs to be cleaned by hand. The fat that is splattered onto the sides of the oven during roasting is eliminated by the microporous coating which breaks the fat down by catalysis and transforms it into gas. Excessive splattering may nevertheless block the pores and therefore hinder self-cleaning. The self-cleaning capacity may be restored by switching on the empty oven to maximum for about 10-20 minutes.

Do not use abrasive products, metal cleaning wads, sharp objects, rough cloths, or chemical products and detergents that may permanently damage the catalytic lining. It is a good idea to use deep roasting trays to roast fatty foods such as joints of meat etc. and to put a tray underneath the grill to catch surplus fat.

These simple precautions will ensure the correct temperature and ideal conditions for catalytic cleaning to take place.

If the walls of the oven are so thickly coated in grease that the catalytic lining is no longer effective remove surplus grease with a soft cloth or sponge soaked in hot water.

The lining must be porous for self-cleaning to be effective.

**N.B.:** All catalytic linings currently on the market have a working life of about 300 hours. They should therefore be replaced after about 300 hours.

## Service centre

### Before calling the Service Centre

If the oven is not working, we recommend that:  
— you check that the oven is properly plugged into the power supply.

If the cause of the fault cannot be detected:  
disconnect the oven from the mains, do not touch the oven and call the after sales service.  
**Before calling the Service Centre remember to make a note of the serial number on the serial number specifications plate.**

The oven is supplied with a guarantee certificate that ensures that it will be repaired free of charge at the Service Centre.

## Grill reflector

The piece concurs the reflection of the infrared beams increasing the efficiency of the baking. For having always a good efficiency of the grill reflector it is necessary to have always clean the reflecting surface.



Place the grill reflector in the oven upper the grill heat element.



The positioning is completed inserting the reflector in the appropriate centers.

## TELESCOPIC SHELF KIT

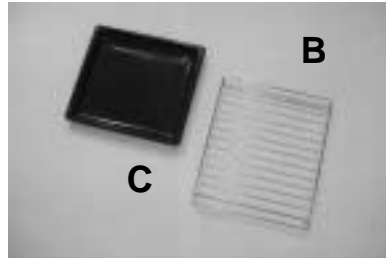
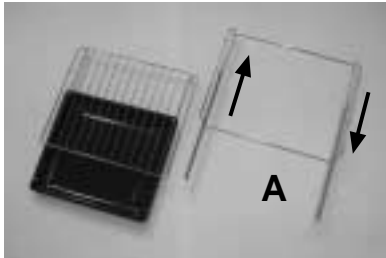

### INSTRUCTION FOR ASSEMBLY

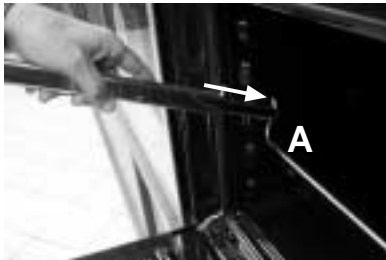

PLACE THE TELESCOPIC RUNNERS **A** IN THE OVEN

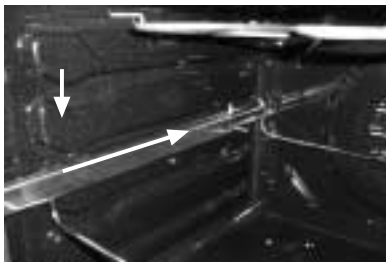

ENSURE THE RUNNERS **A** ARE FIRMLY PUSHED TO THE WALL OF THE OVEN

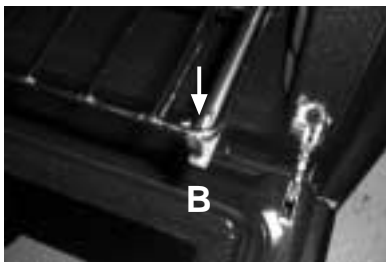

SLIDE OUT THE RUNNERS AND POSITION THE SHELF SUPPORT **B** BEHIND THE SHELF STOP LOCATED AT THE FRONT SIDE OF THE KIT.

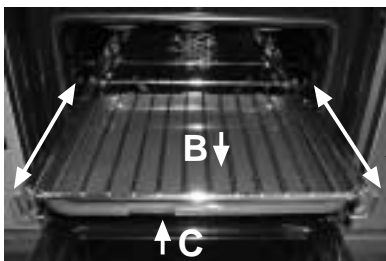

COMPLETE ASSEMBLY BY INSERTING PLAIN SHELF **B** AND DRIP TRAY **C**



## OPERATING INSTRUCTIONS

\* Tested in accordance with the CENELEC EN 50304.

\*\* Tested in accordance with the CENELEC EN 50304 used for definition of energy class.

**Our range includes many different styles and colours. To find the technical specifications and functions of the model which you have bought, study the diagrams below.**

### UPPER OVEN

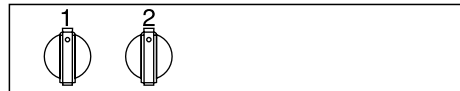

<p>The ovens is fitted with:</p> <ul style="list-style-type: none"> <li>• a bottom element;</li> <li>• a top element for infra-red heating, or grilling</li> </ul>	<p><b>1</b></p> <p>Function/thermostat dial</p>	<p><b>2</b></p> <p>Grill regulator</p>
<p>Turn the control dial to  the light will remain on during all the following phases.</p>		
<p>Temperature setting and the oven's top and bottom elements.</p>	<p>50 ÷ MAX</p> <p>**</p>	
<p><b>Lower heating element.</b> This particular function is ideal for warming meals or for slow cooking.</p>		
<p><b>Variable grill</b> Select the grilling function and set the required power by turning the regulator dial between the position from 1 to 6. The amber light will switch off once the correct setting has been achieved.</p>		<p>1 ÷ 6</p>

## LOWER OVEN

Electronic programmer

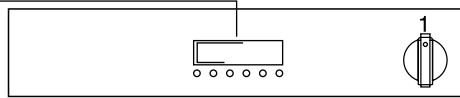

The oven is fitted with:

- a bottom element;
- a top element for infra-red heating, or grilling

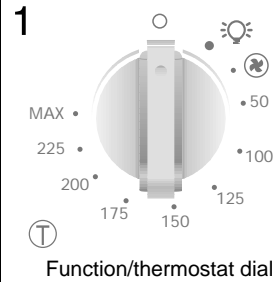

Turn the control dial to the light will remain on during all the following phases.



**Fan oven**

Air that has been heated to a temperature between 50 and 240 is blown by the fan onto the different levels. It is ideal for cooking different types of food at the same time (e.g. meat and fish) without mixing tastes and smells. It cooks very gently and is ideal for sponge cakes, pastries, etc.

50 ÷ MAX



\*

## LOWER OVEN

Electronic programmer

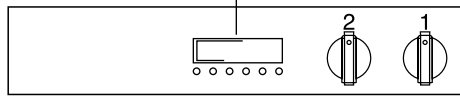

<p>The oven is fitted with:</p> <ul style="list-style-type: none"> <li>• a bottom element;</li> <li>• a top element for infra-red heating, or grilling</li> </ul>	<p style="text-align: center;"><b>2</b></p> <p style="text-align: center;">Thermostat dial</p>	<p style="text-align: center;"><b>1</b></p> <p style="text-align: center;">Function dial</p>
<p>Turn the control dial to  the light will remain on during all the following operations. The cooling fan is also switched on.</p>		
<p><b>Defrosting</b> When the dial is set to this position. The fan circulates air at room temperature around the frozen food so that it defrosts in a few minutes without the protein content of the food being changed or altered.</p>		
<p><b>Fan oven</b> Air that has been heated to a temperature between 50 and 240 is blown by the fan onto the different levels. It is ideal for cooking different types of food at the same time (e.g. meat and fish) without mixing tastes and smells. It cooks very gently and is ideal for sponge cakes, pastries, etc.</p>	<p>50 ÷ MAX</p>	 *
<p><b>Door closed fan grill</b> The air is heated by the grill element and the fan blows the air onto the food at the required temperature. This ranges from 50°C to 200°C. The grill/fan is an excellent alternative to roasting on the spit. It is ideal for roasting even large quantities of poultry, sausages and red meats.</p>	<p>50 ÷ 200</p>	
<p><b>Fan plus lower element</b> This function is ideal for delicate dishes (pies-souffle).</p>	<p>50 ÷ MAX</p>	
<p><b>Natural convection</b> Bottom and top oven elements are used. This is the traditional form of baking and roasting. It is ideal for roasting joints of meat and game, baking biscuits and apples and making the food nice and crunchy. You will get the best results if you put the food on the same shelf and set the temperature between 50°C and 240°C.</p>	<p>50 ÷ MAX</p>	 * *
<p><b>Door closed Grilling</b> The setting of this function switches on the infrared grill element. This function is ideal for cooking meats of medium thickness (sausages and bacon).</p>	<p>50 ÷ MAX</p>	
<p><b>Pastry function</b> The intense heat generated when using this function is similar to that produced in traditional wood-fired ovens.</p>	<p>50 ÷ MAX</p>	



## OVEN: “GRILLING”

The grill can be used either with door closed, or ajar, according to the type of cooking being done.

Below are some guidelines when using the grill. Personal experience will allow you to adapt these guidelines according to your preferences.

- Position 3** : use of grill with door closed.  
For keeping plates or cooked foods warm.
- Position 4** : use of grill with door closed.  
Ideal for browning items already cooked, such as endives, hamburgers etc.
- Position 5** : use of grill with door closed.  
Ideal for cooking white meats.
- Position 6** : use of grill with door ajar.  
Ideal for toasting bread, grilling sausages etc.

When the oven is operating, the power-on indicator light comes on.  
The head indicator light goes on and off throughout cooking time.

### SETTING THE CORRECT TIME



**WARNING** : the first operation to carry out after the oven has been installed or following the interruption of power supply (this is recognizable the display pulsating and showing 0:00 ) is setting the correct time. This is achieved as follows

- Press and hold the TIMER and 🔔 buttons
- Set time with ▼ ▲ buttons
- Release all buttons

**ATTENTION** the oven only operates if set on manual function 🖐️ or preset time.

## PROGRAMMING THE LOWER OVEN

### *Programming the oven for a period and immediate start.*

- The oven must be in Manual position (Auto symbol off): if not, press the button “”.
- Select a cooking method and the appropriate temperature.  
*The indicator lamps come on.*
- Program a cooking period:



. Press the button “2”.  
The symbol “” is displayed.



. Set a period using the “+” and “-” buttons (maximum 24 hours).

. The programmer records the period and automatically calculates the end-of-cooking time.  
The oven is in Auto mode (Automatic).  
The current time is displayed.



- During the cooking period, you can view or change:
  - . The programmed period: press the button “2”.
  - . The end time: press the button “3”.
- The oven stops automatically once the time has elapsed. The symbol “” disappears. The lighting in the oven and the indicator lamps go off. An audible beep sounds as a warning. To interrupt it, press one of the buttons «1», «2», «3» or «4». *The “Auto” symbol blinks; to stop it, reset to Manual position by pressing button “”.*
- Return the two selectors to the stop position.

## PROGRAMMING THE LOWER OVEN

### *Programming the oven for an end time and immediate start.*

- The oven must be in Manual position (Auto symbol off): if not, press the button “”.
- Select a cooking method and the appropriate temperature.  
*The indicator lamps come on.*

- Program a cooking end time

. Press the button “3”.  
The symbol “” is displayed.



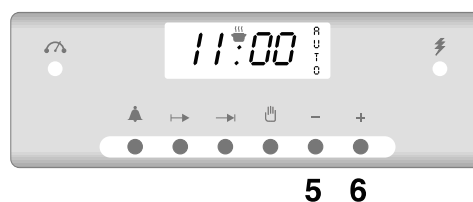

. Press the button “+”:  
the programmer displays the current time  
and the Auto symbol.

. Set an end-of-cooking time using  
the buttons “-” and “+” (current  
time + maximum 24 hours).



. The programmer records the end-of-cooking time and automatically calculates the cooking period. It is in Auto mode (Automatic). The current time is displayed.

- During the cooking period, you can view or change:
  - . The programmed period: press the button “2”.
  - . The end time: press the button “3”.
- The oven stops automatically once the end-of-cooking time is reached. The symbol “” disappears. The lighting in the oven and the indicator lamps go off. An audible beep sounds as a warning. To interrupt it, press one of the buttons «1», «2», «3» or «4». *The “Auto” symbol blinks; to stop it, reset to Manual position by pressing button “”.*
- Return the two selectors to the stop position.

## PROGRAMMING THE LOWER OVEN

### *Programming the oven for a delayed start.*

- The oven must be in Manual position (Auto symbol off): if not, press the button "☞".
- Select a cooking method and the appropriate temperature.  
*The indicator lamps come on.*
- Program a cooking period:
  - . Press the button "2", then set a period with the buttons "-" and "+".
- Program an end-of-cooking time:
  - . Press the button "3" then the button "+": the programmer displays the current time and the Auto symbol.
  - . Set an end-of-cooking time using the buttons "-" and "+" (current time + maximum 24 hours).

The Auto symbol is steady. The symbol "☞" disappears. The current time is displayed.

- The programmer calculates the cooking start time. It automatically starts the cooking and then displays the symbol "☞".
- At any time, you can view or change the programmed period (press the button "2"), or the end time (press the button "3").
- The oven stops automatically once the end-of-cooking time is reached. The symbol "☞" disappears. The lighting in the oven and the indicator lamps go off. An audible beep sounds as a warning. To interrupt it, press one of the buttons "1", "2", "3" or "4".  
*The "Auto" symbol blinks; to stop it, reset to Manual position by pressing the button "☞".*
- Return the two selectors to the stop position.

## PROGRAMMING THE LOWER OVEN

### 🔔 THE TIMER

Timer operation is independent and does not affect oven operation. It is just an audible reminder. However, you can use it when cooking.

- Press the button “1” and then release.

*The symbol “🔔” is displayed and the clock shows:*



- Display the time required using the “+” and “-” buttons (maximum 24 hours).
- The display again shows the time of day with the Timer symbol “🔔”.

When the set time has elapsed, an audible beep sounds for 60 seconds. To interrupt the beep, press one of the buttons “1”, “2”, “3” or “4”.

The display “🔔” disappears.

*Whenever you want to check or change the programmed time, press again on the button “1”.*

## COOKING TIPS

Temperatures and cooking times are given for information only to facilitate using the oven. Personal experience should then let you adapt these settings to your taste and habits.

Remember that cooking at higher temperatures causes more spattering, and the oven can become dirty and smoky. It is better to slightly reduce the cooking temperature, even if it means increasing the cooking time.



The sides of the oven are equipped with different positions numbered from the bottom.

### ***FISH***

Recipes	<i>Cooking method</i>	Quantity	Cooking °C	Cooking time	Shelf position from bottom
Tilefish or bream	<i>Conv cooking</i>	1kg whole	220°C	30 min	1
Monk fish or Salmon	<i>Conv cooking</i>	1kg braised	220°C	30 min	1
Salmon steak	<i>Fan cooking</i>	6 pieces	140-160°C	10-15 min	1
Fillet of sole	<i>Fan cooking</i>	6 pieces	160°C	15-20 min	1
Grilled fish	<i>Grill</i>	6 fillets	275°C	2 X 5 min	4

## COOKING TIPS

### **MEAT**

---

It is better not to salt meats until after cooking as salt encourages the meat to spatter fat. This will dirty the oven and make a lot of smoke.

Joints of white meat, pork, veal, lamb and fish can be put into the oven cold. The cooking time is longer than in a preheated oven, but it cooks through to the centre better as the heat has more time to penetrate the joint.

**Correct preheating is the basis of successful red meat cookery.**

### **GRILLS**

- Before loading the grill:

Remove the meat from the refrigerator a few hours before grilling. Lay it on several layers of kitchen paper: this improves searing, making it tastier and avoids it staying cold at the centre.

Add pepper and spices to the meat before grilling, but add any salt after cooking. This way it will sear better and stay juicy. Baste all the food to be cooked with a little oil. This is best done with a wide flat basting brush. Then sprinkle with more pepper and herbs (thyme, etc.).

Load the grill.

- During cooking:

Never pierce the food during cooking even when you turn it. This lets the juice out and it becomes dry.

## MEAT

Recipes	Cooking method	Quantity	Cooking °C	Cooking time	Tips
Beef with carrots	<i>Conv cooking</i>	for 6	200-220°C	about hours	
Duck	<i>Conv cooking</i>	1,5 kg	200-220°C	1½ hours	
Turkey	<i>Conv cooking</i>	5/6 kg	160-180°C	2½ – 3 hours	
Goose	<i>Conv cooking</i>	3/4 kg	160-180°C	2 – 2½ hours	
Leg of lamb	<i>Conv cooking</i>		200-220°C	15 min/pound	
Roast chicken	<i>Conv cooking</i>	1/1,5 kg	220°C	about 1 hour	
Roast beef	<i>Conv cooking</i>		240°C	15 min/pound	
Roast rabbit	<i>Fan cooking</i>	800-1 kg	200-220°C	50-60 mins	
Roasted white meat	<i>Fan cooking</i>		200-220°C	40-50 mins/kg	
Veal / poultry	<i>Rotisserie</i>	1kg 200	275°C	60-70mins/kg	No preheat.
Veal / poultry	<i>Rotisserie</i>	1 kg	275°C	45-50 min	No preheat.
Beef	<i>Rotisserie</i>	1 kg	275°C	15-20 min	No preheat.
Lamb / Mutton	<i>Rotisserie</i>	1 kg	275°C	20-25 min	No preheat.
Pork	<i>Rotisserie</i>	1 kg	275°C	45-50 min	No preheat.
Kebabs	<i>Grill</i>	6 pieces	275°C	2 X 8 min	Turn over in mid cooking
Pork chop	<i>Grill</i>	6 pieces	275°C	2 X 8 min	Turn over in mid cooking

*All cooking was done at shelf position "1".*



## VEGETABLES - OTHERS

Recipes	Cooking method	Quantity	Cooking °C	Cooking time	Tips
Braised cabbage	<i>Conv cooking</i>	for 6	200-220°C	1 hour	
Pâté en croûte	<i>Conv cooking</i>		200-220°C	1 hour/kg	
Chicory with gruyere	<i>Fan cooking</i>	for 6	180-200°C	25-30 min	
Potatoes in their jackets	<i>Fan cooking</i>	for 6	200-220°	about 1 hour	
Soufflé savoury/sweet	<i>Fan cooking</i>	for 6	180-200°C	50-60 min	Ø 22
Stuffed tomatoes	<i>Fan cooking</i>	6-8 pieces	200-220°C	40-45 min	
Leek flan	<i>Fan + lower element</i>	for 6	220°C	35-40 min	
Quiche Lorraine	<i>Fan + lower element</i>	for 6	220°C	45-50 min	
Toast with crottin*	<i>Turbo grill</i>	6 pieces	210°C	3 min to toast one side + 4 min/crottin	Flat steak pan
Dauphiné cheese-topped dish	<i>Turbo grill</i>	6 portions	200°C	45 min	Oval earthenware
Toulouse sausages*	<i>Turbo grill</i>	4 pieces	210°C	2 x 10 min turn over in mid cookin	Flat steak pan

All the cooking was done at shelf position "1" except cooking marked thus "\*\*\*", which requires cooking at a middle position.

## BAKING

Avoid using shiny tins, they reflect the heat and can spoil your cakes. If your cakes brown too quickly, cover them with grease-proof paper or aluminium foil. Caution: the correct way to use foil is with the shiny side in towards the cake. If not the heat is reflected by the shiny surface and does not penetrate the food. Avoid opening the door during the first 20 to 25 minutes of cooking: soufflés, brioches, sponge cakes, etc. will tend to fall. You can check if cakes are done by pricking the centre with a knife blade or metal knitting needle. If the blade comes out nice and dry, your cake is ready and you can stop cooking. If the blade comes out moist or with bits of cake attached, continue baking but slightly lower the thermostat so that it is finished off without burning.

Recipe	Cooking method	Quantity	Cookin °C	Cooking time	Shelf level	Tips
Cake	<i>Conv cooking</i>	1,5 kg	180-200°C	50-60 min	1	
Fruit tart in batter	<i>Conv cooking</i>	for 6	200-220°C	40-50 min	1	Ø 27
Pound cake	<i>Conv cooking</i>	1,5 kg	200-220°C	45-50 min	1	
Filled pie	<i>Conv cooking</i>	for 6	200-220°C	40-45 min	1	Ø 27
Brioche	<i>Fan cooking</i>	800 grs	200°C	40-45 min	1	
Sponge cake	<i>Fan cooking</i>	180-200°C		35-40 min	1	mould Ø27
Genoese cake	<i>Fan cooking</i>	180-200°C		30-35 mi	1	mould Ø27
Choux pastry	<i>Fan cooking</i>	40 piece	190°C	35 mi	1/3	2 trays
Pastry base	<i>Fan cooking</i>	for 6	180-200°C	20-30 min	1	Ø 27
Puff pastry	<i>Fan cooking</i>	6 pieces	200°C	15-20 min	1	e.g. Bouchée
Meringues	<i>Fan + Lower element*</i>	1 tray	80-85°C	4 ½ hours	1	Øprofiteroles
Fruit tart	<i>Fan + Lower element*</i>	for	220°C	35-40 min	1	
St Honoré	<i>Fan + Lower element*</i>	6 piece	190°C	30-35 min	1	

\* with fan and lower element, we recommend preheating with fan cooking to save time.

## INSTALLATION

**Installing a domestic appliance can be a complicated operation which, if not carried out correctly, can seriously affect consumer safety.**

**It is for this reason that the task should be undertaken by a professionally qualified person who will carry it out in accordance with the technical regulations in force.**

**In the event that this advice is ignored and the installation is carried out by an unqualified person, Hoover declines all responsibility for any technical failure of the product whether or not it results in damage to goods or injury to individuals.**

Installation is the customer's responsibility. The manufacturers have no obligation to carry this out. If the assistance of the manufacturer is required to rectify faults arising from incorrect installation, this assistance is not covered by the guarantee.

The installation instructions for professionally qualified personnel must be followed. Incorrect installation may cause harm or injury to people, animals or things. The manufacturer cannot be held responsible for such harm or injury.

### **FITTING THE OVEN INTO THE KITCHEN UNIT**

Fit the oven into the space provided in the kitchen unit: it may be fitted underneath a work top or into an upright cupboard.

Fix the oven in position by screwing into place, using the four fixing holes in the frame. To locate the fixing holes, open the oven door and look inside.

To allow adequate ventilation, the measurements and distances indicated in the diagram on page 21 be adhered to when fitting the oven.

### **IMPORTANT**

If the oven is to work properly, the kitchen housing must be suitable.

The panels of the kitchen unit that are next to the oven must be made of a heat resistant material. Ensure that the glues of units made of veneered wood can withstand temperatures of at least 120 °C. Plastics or glues that cannot withstand such temperatures will melt and deform the unit. Once the oven has been lodged inside the unit, the electrical parts must be completely insulated. This is a legal safety requirement. All guards must be firmly fixed into place so that it impossible to remove them without using special tools.

**Remove the back of the kitchen unit to ensure an adequate current of air circulates around the oven.**

## **INSTALLATION: "ELECTRICAL CONNECTION"**

The mains electricity supply connected to the appliance should comply with the norms in force in the country of installation.

Hoover declines all responsibility for any damage that may be caused by unsuitable or unreasonable use.

### **Warning:**

- Always check before any electrical operation, the supply voltage shown on the electricity meter, the adjustment of the circuit-breaker, the continuity of the connection to earth of the installation and that the fuse is suitable.

- The electrical connection to the installation should be made via a socket with a plug with earth, or via an omnipole cut-out switch with an opening gap of at least 3 mm.
- The yellow/green wire of the power supply cable must be connected to the earth of both power supply and appliance terminals.
- Hoover cannot be held responsible for any accidents resulting from the use of an appliance which is not connected to earth, or with a faulty earth connection continuity.
- Any queries regarding the power supply cord should be referred to After Sales Service or a qualified technician.
- The yellow-green earthing cable must not be governed by the ON/OFF switch. The socket or the ON/OFF switch used for connecting to the power supply must be easily accessible when the oven has been installed.
- **Important:** During installation, position the power cable in such a way that it will not be subjected to temperatures of above 50°C at any point.
- The cabling and wiring system must be able to bear the maximum electric power required by the oven. This is indicated on the specifications plate. If you are in any doubt at all, use the services of a professionally qualified person.
- **WARNING: the voltage and the supply frequency are showed on the rating plate**

**- Operations to be carried out to make a new connection:**

- Choose the supply cord in accordance with the recommendations in the table

- The oven must be in situation as shown:



- Pass the supply cord into the clamp.
- Strip the end of each conductor of the supply cord a 10 mm length, by taking in account the cord for the connection on the terminal block.
- According to the installation and with the help of should have recovered in the first operation, fix the conductor as shown on the chart.
- Engage the earth wire yellow/green on the earth terminal, tighten the nut and verify the continuity of the earth.
- Secure the cable clamp.
- Fix the cover.

## CABLE

Area	3 G 2,5 mm <sup>2</sup>	3 G 2,5 mm <sup>2</sup>
<p><b>Connection to the terminal block</b></p>		
<p>To shunt : make a bridge with a shunt bar</p>	<p><u>1 rst Phase</u> Shunt                    1-2 Shunt                    2-3 <u>Neutral</u> Shunt                    4-5</p> <p style="text-align: center;">Earth                    </p>	<p><u>1 rst Phase</u> Shunt                    1 <u>Neutral</u> Shunt                    2</p> <p style="text-align: center;">Earth                    </p>

**IMPORTANT: Blue wire = Neutral      Yellow/green wire = Earth**

For the connection to the terminal block, you must:

- respect the n° 1,2,3,4, and 5,
- tighten the screws,
- do not forget to fix the earth wire (yellow/green) on the earth terminal n° 6

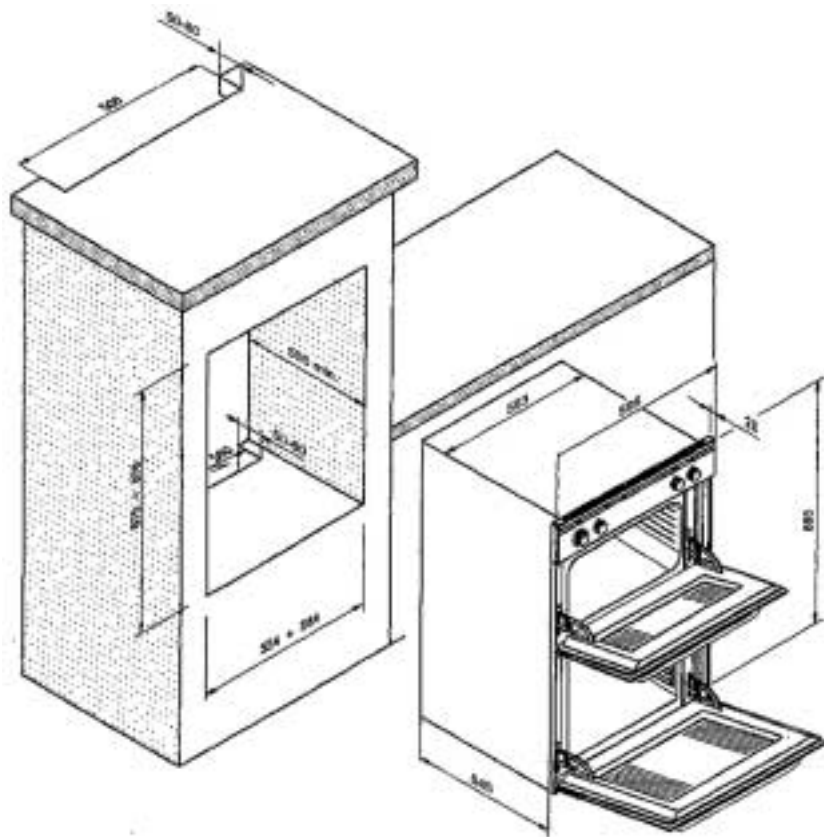



This appliance is marked according to the European directive 2002/96/EC on Waste Electrical and Electronic Equipment (WEEE). By ensuring this product is disposed of correctly, you will help prevent potential negative consequences for the environment and human health, which could otherwise be caused by inappropriate waste handling of this product.

The symbol on the product indicates that this product may not be treated as household waste. Instead it shall be handed over to the applicable collection point for the recycling of electrical and electronic equipment.

Disposal must be carried out in accordance with local environmental regulations for waste disposal.

For more detailed information about treatment, recovery and recycling of this product, please contact your local city office, your household waste disposal service or the shop where you purchased the product.