



BORN INNOVATIVE

EN





Thank you for choosing this product. We are proud to offer the ideal product for you and the best complete range of home appliances for your daily routine.

Carefully read this manual for correct and safe appliance use and for helpful tips on efficient maintenance.



Only use the washing machine after carefully reading these instructions. We recommend you always keep this manual on hand and in good condition for any future owners.

#### **FOR U.K. ONLY**

***On receipt of your appliance please check it carefully for damage. Any damage found must be reported to the delivery driver immediately. Alternatively damage found must be reported to the retailer within 2 days of receipt.***

Each product is identified by a unique 16-character code, also called the “serial number”, printed on the sticker. This can be found inside the door opening. This code is a unique code for your product that you will need to register the product warranty, or if you need to contact the Customer Service Centre.

### **Environmental conditions**



This appliance is marked according to the European directive 2012/19/EU on Waste Electrical and Electronic Equipment (WEEE).

WEEE contains both polluting substances (which can cause negative consequences for the environment) and basic components (which can be re-used). It is important to have WEEE subjected to specific treatments, in order to remove and dispose properly all pollutants, and recover and recycle all materials. Individuals can play an important role in ensuring that WEEE does not become an environmental issue; it is essential to follow some basic rules:

- WEEE should not be treated as household waste;
- WEEE should be handed over to the relevant collection points managed by the municipality or by registered companies. In many countries, for large WEEE, home collection could be present.

In many countries, when you buy a new appliance, the old one may be returned to the retailer who has to collect it free of charge on a one-to-one basis, as long as the equipment is of equivalent type and has the same functions as the supplied equipment.

## **Contents**

- 1. GENERAL SAFETY RULES**
- 2. INSTALLATION**
- 3. DETERGENT DRAWER**
- 4. PRACTICAL HINTS**
- 5. CLEANING AND MAINTENANCE**
- 6. PORTHOLE EMERGENCY OPENING**
- 7. REMOTE CONTROL (WI-FI)**
- 8. QUICK USER GUIDE**
- 9. CONTROLS AND PROGRAMS**
- 10. TROUBLESHOOTING AND WARRANTY**

# 1. GENERAL SAFETY RULES

- This appliance is intended to be used in household and similar applications such as:

- Staff kitchen areas in shops, offices and other working environments;
- Farm houses;
- By clients in hotels, motels and other residential type environments;
- Bed and breakfast type environments.

A different use of this appliance from household environment or from typical housekeeping functions, as commercial use by expert or trained users, is excluded even in the above applications. If the appliance is used in a manner inconsistent with this it may reduce the life of the appliance and may void the manufacturer's warranty. Any damage to the appliance or other damage or loss arising through use that is not consistent with domestic or household use (even if located in a domestic or household environment) shall not be accepted by the manufacturer to the fullest extent permitted by law.

- This appliance can be used by children aged from 8 years and above and persons with reduced physical, sensory or mental capabilities or lack of experience and knowledge if they have been given supervision or instruction concerning use of the appliance

in a safe way and understand the hazards involved.

Children shall not play with the appliance. Cleaning and user maintenance shall not be made by children without supervision.

- Children should be supervised to ensure that they do not play with the appliance.
- Children of less than 3 years should be kept away unless continuously supervised.
- If the supply cord is damaged, it must be replaced by a special cord or assembly available from the manufacturer or its service agent.
- Only use the hose-sets supplied with the appliance for the water supply connection (do not reuse old hose-sets).
- Water pressure must be between 0.05 MPa and 0.8 MPa.
- Make sure carpets or rugs do not obstruct the base or any of the ventilation openings.
- After installation, the appliance must be positioned so that the plug is accessible.
- The maximum load capacity of dry clothes depends on the model used (see control panel).
- To consult the product technical specification please refer to the manufacturer website.

## Electrical connections and safety instructions

- The technical details (supply voltage and power input) are indicated on the product rating plate
- Make sure that the electrical system is earthed, complies with all applicable law and that the (electricity) socket is compatible with the plug of the appliance. Otherwise, seek qualified professional assistance.
- The use of converters, multiple sockets or extension cords is strongly advised against
- Before cleaning or maintaining the washing machine, unplug the appliance and turn off the water tap.
- Do not pull on the power cord or appliance to unplug the machine.
- Make sure there is no water in the drum before opening the door.
- Do not expose the washing machine to rain, direct sunlight or other weather elements. Protect from possible freezing.
- When moving, do not lift the washing machine by the knobs or detergent drawer; during transport, never rest the door on the trolley. We recommend two people lift the washing machine.
- In the event of fault and/or malfunction, turn off the washing machine, close the water tap and do not tamper with the appliance. Immediately contact the Customer Service Centre and only use original spare parts. Failure to observe these instruction may jeopardise appliance safety.



**WARNING:**  
water may reach very high temperatures during the wash cycle.

## 2. INSTALLATION

- Remove the **2** or **4** transportation screws (**A**) on the back and remove the **2** or **4** flat washers, rubber bungs and plastic spacer tubes (**B**) as illustrated in **figure 1**.
- If the washing machine is **built-in**, unscrew the **3** or **4** transportation screws (**A**) and remove the **3** or **4** flat washers, rubber bungs and plastic spacer tubes (**B**).
- During the removal of the screws occasionally spacer tubes fall inside the product, these can be removed by tilting the product forward and recovering them from the floor or inside the base of the machine.
- Cover the open transportation screw holes with the **2** or **4** plastic caps included in the instruction bag.



**WARNING:**  
keep packaging materials  
away from children.

- Place the corrugated plastic sheet, found on top of the appliance during the unpacking process, into the base of the appliance as shown in **figure 2** (according to the model, consider version **A**, **B** or **C**).

**In some models this operation will not be necessary, because the corrugated plastic sheet will be already placed on the bottom of the appliance.**

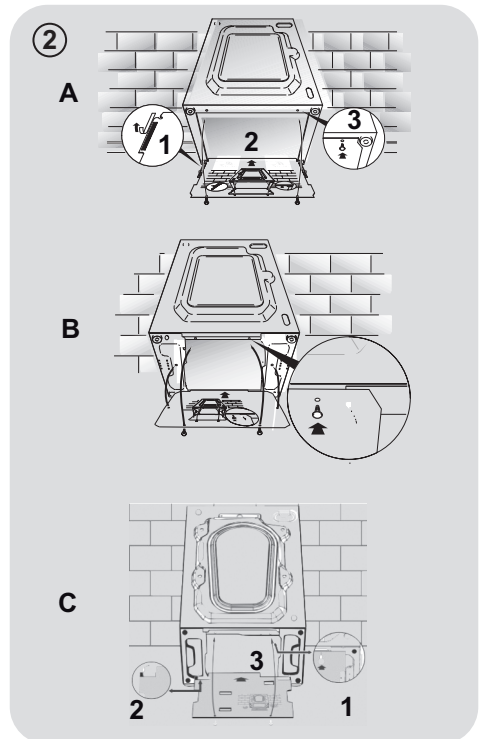
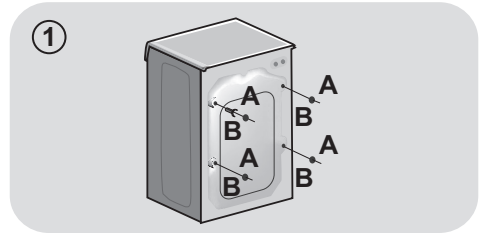

## Hydraulic connections

- Connect the water hose to the water supply tap (**fig. 3**) only using the hose supplied with the appliance (do not reuse old hose-sets).

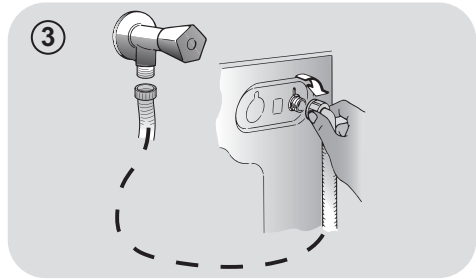

- **SOME MODELS** may include one or more of the following features:

- **HOT&COLD (fig. 4):**

water mains connection settings with hot and cold water for higher energy savings. Connect the grey tube to the cold water tap ❄️ and the red one to the hot water tap. The machine can be connected to the cold water tap only: in this case, some programs may start a few minutes later.

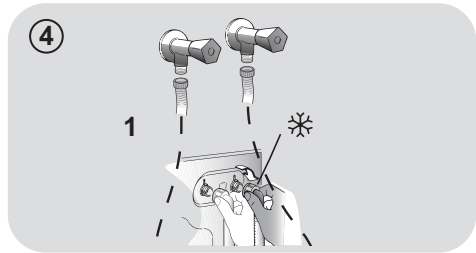

- **AQUASTOP (fig. 5):**

a device located on the supply tube that stops water flow if the tube deteriorates; in this case, a red mark will appear in the window "A" and the tube must be replaced. To unscrew the nut, press the one-way lock device "B".

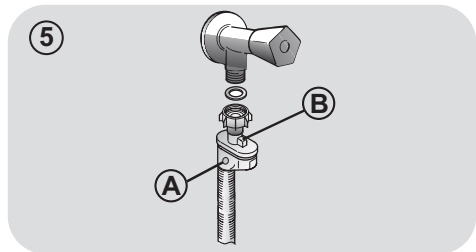

- **AQUAPROTECT – SUPPLY TUBE WITH GUARD (fig. 6):**

Should water leak from the primary internal tube "A", the transparent containment sheath "B" will contain water to permit the washing cycle to complete. At the end of the cycle, contact the Customer Service Centre to replace the supply tube.

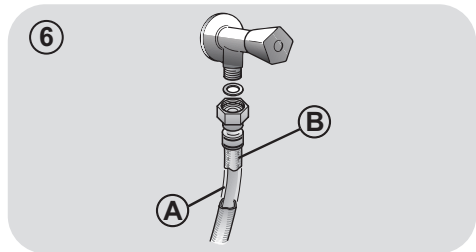

## Setting

- The washing machine should be installed in its final position such that the water fill hose is not kinked or trapped. The corrugated drain hose should be inserted into suitable drain pipe of between 50 cm and 85 cm height above the floor using the curved drain hose support. If an under sink connection is used the drain hose must be routed above the sink overflow opening to prevent back siphoning. Care must be taken to avoid kinking or trapping the drain hose (**fig. 7**).
- Level the appliance using the feet as illustrated in **figure 8**:
  - a. turn the nut clockwise to release the screw;
  - b. rotate the foot to raise or lower it until it touches to the floor;
  - c. lock the foot, screwing in the nut, until it tightens against the bottom of the washing machine.
- Plug in the appliance.



### WARNING:

contact the Customer Service Centre should the power cord need replacement.

Installation faults are not covered by the manufacturers warranty.

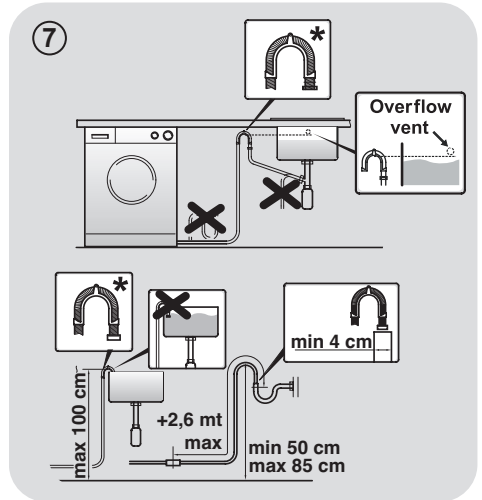

\* ACCESSORY SOLD SEPARATELY

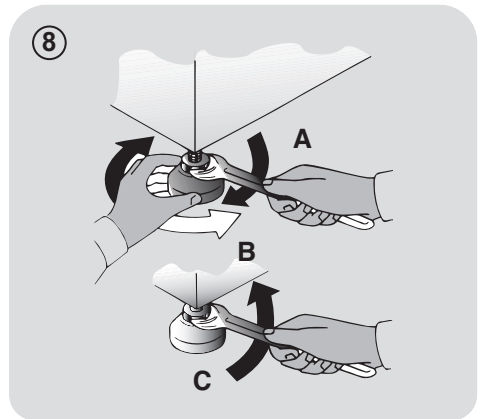



### 3. DETERGENT DRAWER

The detergent draw is split into 3 compartments as illustrated in **figure 9**:

- **compartment "1"**: for prewash detergent;
- **compartment "2"**: for special additives, softeners, starch fragrances, etc.;

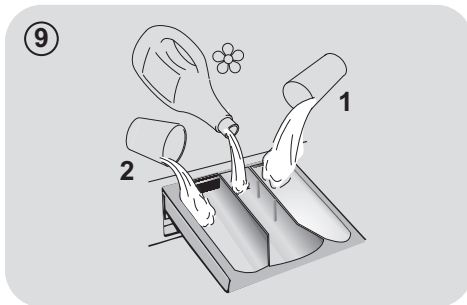

EN

#### **WARNING:**

**only use liquid products; the washing machine is set to automatically dose additives at each cycle during the last rinse.**

- **compartment "2"**: for washing detergent.

**A liquid detergent cup is also included IN SOME MODELS (fig. 10).** To use it, place it in **compartment "2"**. This way, liquid detergent will only enter the drum at the right time. The cup can also be used for bleach when the "Rinse" program is selected.

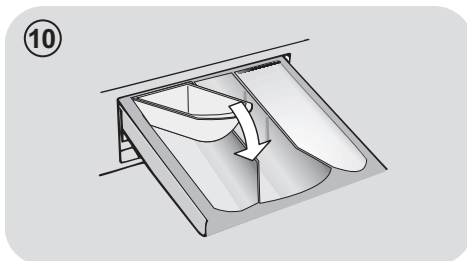

#### **WARNING:**

**some detergents are not designed for use in the dispenser drawer but are supplied with their own dispenser that is placed in the drum directly.**

**SOME MODELS** are provided with the automatic dosage, this carries out a precise measurement of detergent and softener. In this case, refer to the specific section in the **CONTROLS AND PROGRAMS** chapter for details.

## 4. PRACTICAL HINTS

### Load tips

#### When sorting laundry, make sure:

- have eliminated metallic objects such as hair clips, pins, coins, from laundry;
- to have buttoned pillow cases, closed zips, tied loose belts and long robe ribbons;
- to have removed rollers, hooks or clips from curtains;
- to have carefully read clothing washing labels;
- to have removed any persistent stains using specific detergents.
- When washing rugs, bedcovers or other heavy clothing, we recommend you avoid the spinning cycle.
- To wash wool, make sure the item can be machine washed. Check the fabric label.
- Leave the appliance's door slightly open between washes, to prevent possible bad smells developing inside the machine.

### Useful advice for saving

Tips on how to save money and not damage the environment when using your appliance.

- Load the machine to the highest capacity shown in the programme table for each programme - this will allow you to SAVE energy and water.
- Noise and residual laundry moisture are affected by spin speed: a faster spin is associated with greater noise and lower residual moisture in the laundry.
- The most efficient programmes in terms of combined use of water and energy are usually the longer-lasting ones with lower temperature.

### Maximise the load size

- Achieve the best use of energy, water, detergent and time by using the recommended maximum load size. Save up to 50% energy by washing a full load instead of 2 half loads.

### Do you need to pre-wash?

- For heavily soiled laundry only! SAVE detergent, time, water and between 5 to 15% energy consumption by NOT selecting Prewash for slight to normally soiled laundry.

### Is a hot wash required?

- Pretreat stains with stain remover or soak dried in stains in water before washing to reduce the necessity of a hot wash programme. Save energy by using a low temperature wash programme.

### Before using a drying programme (WASHER-DRYERS)

- SAVE energy and time by selecting a high spin speed to reduce the water content in laundry before using a drying programme.

### Dosing the detergent

Below is a **short guide** with tips and advice **on the use of detergent**.

- Only use detergents suitable for machine washing.
- Select your detergent according to the type of fabric (cotton, delicates, synthetics, wool, silk, etc.), the colour, the type and level of soiling and the programmed washing temperature.
- To use the right amount of detergent, softener or any other additives, carefully follow the manufacturer's instructions every time: **correctly using the appliance with the right dose allows you to avoid waste and to reduce the environmental impact.**

**When washing heavily soiled whites, we recommend using cotton programs of 60°C or above and a normal washing powder (heavy duty) that contains bleaching agents that at medium/high temperatures provide excellent results.**

**For washes between 40°C and 60°C** the type of detergent used needs to be appropriate for the type of fabric and level of soiling. Normal powders are suitable for “white” or colour fast fabrics with high soiling, while liquid detergents or “colour protecting” powders are suitable for coloured fabrics with light levels of soiling.

**For washing at temperatures below 40°C** we recommend the use of liquid detergents or detergents specifically labeled as suitable for low temperature washing.

For washing **wool** or **silk**, only use detergents specifically formulated for these fabrics.

- Too much detergent leads to excessive foam, which prevents the cycle being carried out correctly. It could also affect the quality of the washing and rinsing.

The use of ecological detergents without phosphates may cause the following effects:

- **cloudier rinse drain water:** This effect is tied to the suspended zeolites which do not have negative effects on rinse efficiency.
- **white powder (zeolites) on laundry at the end of the wash:** this is normal, the powder is not absorbed by fabric and does not change its colour.  
To remove the zeolites, select a rinse programme. In the future consider using slightly less detergent.
- **foam in the water at last rinse:** this does not necessarily indicate poor rinsing. Consider using less detergent in future washes.
- **abundant foam:** This is often due to the anionic surfactants found in the detergents which are hard to eliminate from laundry. In this case, do not re-rinse to eliminate these effects: it will not help at all. We suggest conducting a maintenance wash using a proprietary cleaner.

If the problem persists or if you suspect a malfunction, immediately contact an Authorised Customer Service Centre.

## 5. CLEANING AND MAINTENANCE

Looking after your appliance correctly can extend its lifespan.

### Cleaning the appliance's exterior

- Disconnect the machine from the power supply.
- Clean the appliance's external cabinet, using a damp cloth and **AVOIDING ABRASIVES, ALCOHOL AND/OR DILUENTS.**

### Drawer cleaning

- It is advisable to regularly clean the detergent drawer to avoid the accumulation of detergent and additive residues.
- Remove the drawer gently but firmly.
- Clean the drawer under running water and put it back into its compartment.

**FOR MODELS WITH AUTOMATIC LIQUID DETERGENT AND SOFTENER DOSING SYSTEM:**

**Before proceeding with cleaning, all the compartments must be empty.**

- Pull out the drawer completely by pressing the release button, **paying attention to the leakage of detergent residues.**

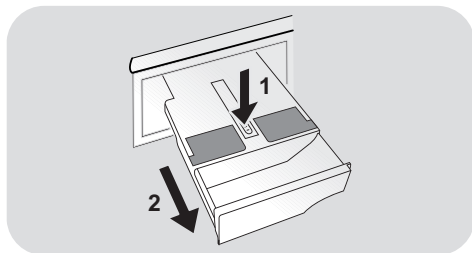

- Fill the drawer with hot water.

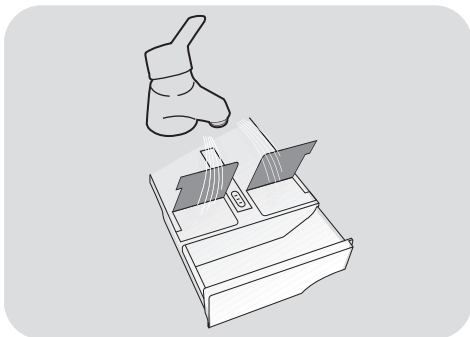

- Shake the drawer in order to let the water flow in all the compartments.

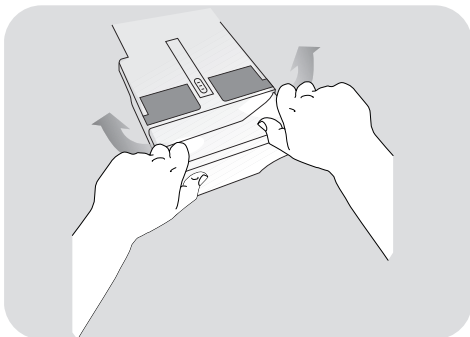

- Empty the drawer from excess water and reinsert it completely.



### **WARNING:**

**DO NOT** use acid products (for example vinegar) or aggressive detergents to clean the drawer, in order to avoid damaging the seals and/or internal parts of the appliance.

## Cleaning the pump filter

- The appliance has a special filter that traps larger residues that could block the draining system, such as buttons or coins (depending on the model, consider version **A** or **B**).

**We recommend checking and cleaning the filter 5 or 6 times a year.**

- Disconnect the machine from the power supply.
- Ensure all the water has been emptied from the drum.
- Before unscrewing the filter, we recommend you place an absorbent cloth under it to keep the floor dry. A small amount of water will come out of the filter as you remove it - this is normal.
- Turn the filter counter-clockwise to the limit stop.
- Remove and clean the filter; when finished, replace it turning it clockwise. The filter handle will be locked when it is not possible to turn any further and the handle is horizontal. Smearing a small amount of liquid soap on the filter seal will help refitting.
- Repeat the previous steps in reverse order to reassemble all parts.

## Suggestions for moves or prolonged disuse

- If the appliance is kept in a non-heated room for long periods of time, all water residues must be completely removed from the pipes.
- Disconnect the machine from the power supply socket.
- Detach the tube from the drainage system and clip on the rear of the machine and lower it, fully draining water into a bowl.
- Secure the drain tube with the drainage system and clip on the rear of the machine when finished.
- Keep the door glass and gasket clean.

### FOR MODELS WITH AUTOMATIC LIQUID DETERGENT AND SOFTENER DOSING SYSTEM:

should you need to tilt or move the machine, remove the detergent drawer before proceeding, keeping it horizontal so as to avoid any leakage.

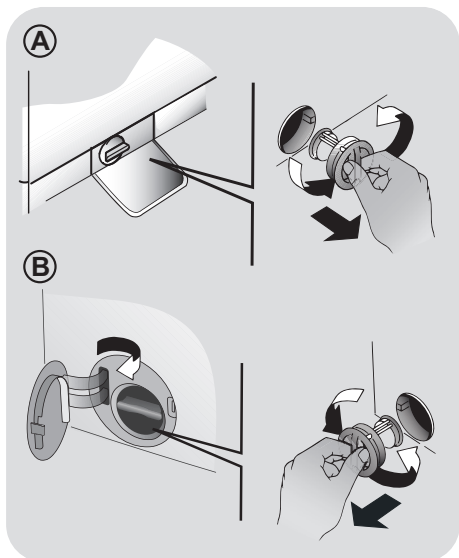

## 6. PORTHOLE EMERGENCY OPENING

Should the porthole be locked due to power Shortage (if the plug is removed before the end of the cycle, re-plug it and turn off the machine to open the door) or as a result of a fault, it can be opened according to the following emergency unlocking procedure:

1. Disconnect the machine from the power socket.
2. Ensure that the water level is below the porthole before opening it, to prevent any flooding. Otherwise, drain excess water through the drain tube and collect it in a bucket.
3. Tilt the machine (or increase the feet height) and remove the visible screw in the front bottom corner of the washing machine (**fig. 1**).
4. Insert a screw driver or a similar tool in the visible hook. Lever down and simultaneously open the porthole as shown in **figure 2**.
5. Remember to re-assemble the screw at the end of the process.

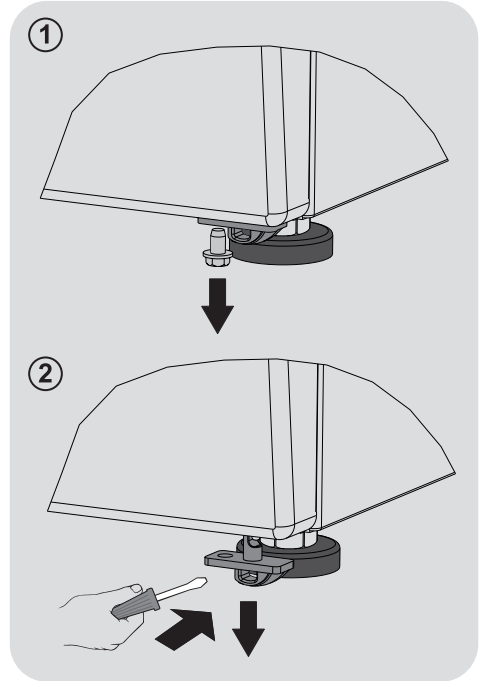

## 7. REMOTE CONTROL (WI-FI)

This appliance is equipped with **Wi-Fi** technology that allows you to control it remotely via App.

### MACHINE ENROLLMENT (ON APP)

- Download the App on your device by framing the following QR code:



or by the link:

[go.haier-europe.com/download-app](http://go.haier-europe.com/download-app)

The App is available for devices running both Android and iOS, both for tablets and for smartphones.

Get all the details of the Wi-Fi functions by browsing the App in DEMO mode.

- Open the App, create the user profile (or log-in if it is already created previously) and enroll the appliance following the instructions on the device display.

### TO ENABLE REMOTE CONTROL

- Check that the router is switched on and connected to the Internet.
- Load the laundry, close the door, add the detergent if it's necessary.
- Turn the programme selector to the **REMOTE CONTROL (Wi-Fi)** position : the door will lock and the controls on the control panel will be disabled.
- Start the cycle using the app. When the cycle has been completed, turn off the machine by turning the programme selector to the **OFF** position to unlock the door.

### TO DISABLE REMOTE CONTROL

- To exit **REMOTE CONTROL** mode while a cycle is underway, turn the programme selector to any position other than **REMOTE CONTROL (Wi-Fi)**. The control panel on the appliance will be operative once again, and if the cycle is paused, you will be able to open the door once the **DOOR LOCKED** indicator light switches off.

For safety reasons, in some wash cycle phases, the door can be opened only if the level of the water is below its lower edge and if the temperature is less than 45°C. If these conditions are met, wait for the **DOOR LOCKED** light to switch off before opening the door.

- With the door closed, turn the knob to the **REMOTE CONTROL (Wi-Fi)** position to control the appliance using the app once again. If there is a cycle underway, it will continue.

## 8. QUICK USER GUIDE

This appliance automatically adjusts the level of the water to the type and quantity of washing. This system gives a reduction in energy consumption and a saving in washing times.

### Program selection

- Turn on the appliance and select the required program.
- Adjust the washing settings if necessary and select the required options.

#### **DRYING (WASHER-DRYERS only)**

If you would like the drying cycle to begin automatically after washing, select the washing programme required and select the drying cycle. Or you can finish the wash and then select the drying programme.

- Press the programme start button.
- The end of the programme will be indicated by a message on the display (on some models, all the indicator lights on the stage will light up).
- Turn off the appliance.

For any type of wash, see the program table and follow the operating sequence as indicated.

### Technical data

#### **Water pressure:**

min 0.05 Mpa / max 0.8 Mpa  
(0.05 MPa dispenses approximately 1 litre of water in 10 seconds)

**Spin r.p.m.:** See rating plate.

**Power input / Power current fuse amp / Supply voltage:** See rating plate.

## 9. CONTROLS AND PROGRAMS



- A START/PAUSE button**
- B TEMPERATURE SELECTION button**
- C SPIN SPEED button**
- D DELAY START button**
- E RAPID / STAIN LEVEL button**
- F OPTIONS button**
- G CARE DOSE button**
- H SPECIAL PROGRAMMES button**
- B+C CHILD LOCK**





## WARNING:

don't touch the buttons while inserting the plug because the machine calibrates the systems during the first seconds: touching the buttons, the machine couldn't work properly. In this case, remove the plug and repeat the operation.

## PROGRAMME selector with OFF position

- When the programme selector is turned the display lights up to show the settings for the programme selected.
- Switch off the washing machine by turning the selector to **OFF**.

## First starting

### - Language setting

- After connecting the machine to the network and turning it on, press the **"B"** or **"C"** button to display the available languages.
- Select the desired language pressing the **START/PAUSE** button.

### - Change the language

If you want to change the setting language you will have to press simultaneously **"D"** and **"E"** buttons for about **5 seconds**. **ENGLISH** will appear on the display, and you will be able to choose a new language.

### - Water Hardness setting

This washing machine, thanks to the **CARE DOSE** system, is able to dose your detergent automatically. The optimum quantity of detergent depending on the water hardness, on the load quantity and on the chosen cycle (cotton, delicates, etc...)

**The default setting for the water hardness is set in the factory at level 2 (L2) as this satisfies the requirements of the majority of users.**

## Water Hardness level:

- L1 = LOW** (0-12 °fH o 0-7 °dH)
- L2 = MEDIUM** (13-30 °fH o 8-17 °dH)
- L3 = HIGH** (≥ 30 °fH o ≥ 17 °dH)

**EN**

- To confirm the standard water hardness level set by the factory, press **START/PAUSE** button.
- If you want to change the standard water hardness setting (and consequently the amount of detergent dispensed), press **CARE DOSE** button.
- Once chosen the water hardness level, confirm by pressing the **START/PAUSE** button.

### - Change the water hardness setting

- If you want to change the water hardness setting (and consequently the amount of detergent dispensed), hold down the **CARE DOSE** button for a few seconds. The wording **WATER HARDNESS** will appear on the display and you can choose the desired level by pressing the **CARE DOSE** button again. **The higher the water hardness, the more detergent will be dispensed.**
- Confirm by pressing the **START/PAUSE** button.

**Check the water hardness LEVEL of your city at your water supply company before using the CARE DOSE function.**

## START/PAUSE button

**Close the door BEFORE selecting the button START/PAUSE.**

- To start the selected cycle with the preset parameters, press **START/PAUSE**. When the programme is running, the display will show the time to elapse.

- Moreover, If you want to modify the chosen programme, press the desired options buttons, modify the default parameters and then press **START/PAUSE** button to start the cycle.

**Only the options compatible with the set programme can be selected.**

- After switching on the appliance, wait a few seconds for the programme to start running.

## PROGRAMME DURATION

- When a programme is selected the display automatically shows the cycle duration, which can vary, depending on the options selected.
- Once the programme has started you will be kept informed constantly of the time remaining to the end of the wash.
- The appliance calculates the time to the end of the selected programme based upon a standard loading, during the cycle, the appliance corrects the time to that applicable to the size and composition of the load.

## PROGRAMME END

- When the display shows that the programme is finished and the DOOR LOCKED indicator light has gone out, the door can be opened.
- At the end of the cycle, switch off the appliance by turning the selector to **OFF**.

**The programme selector must be returned to the OFF position at the end of each cycle or when starting a subsequent wash cycle prior to the next programme being selected and started.**

## PAUSING THE MACHINE

- Keep the **START/PAUSE** button pressed for about **2** seconds (some light indicators and the residual time display will flash, showing that the machine is paused).

**For safety reasons, in some wash cycle phases, the door can be opened only if the level of the water is below its lower edge and if the temperature is less than 45°C. If these conditions are met, wait for the DOOR LOCKED light to switch off before opening the door.**

- Press the **START/PAUSE** button again to re-start the programme from the point it had been paused at.

## CANCELLING THE SET PROGRAMME

- To cancel the programme, set the selector to the **OFF** position.
- Wait until the DOOR LOCKED light has gone out before opening the door.

## TEMPERATURE SELECTION button

- This button allows you to change the temperature of the wash cycles.
- It is not possible to raise the temperature over the maximum allowed for the programme, in order to protect the fabrics.
- If you want carry out a cold wash all the indicators must be off.

## SPIN SPEED button

- By pressing this button, it is possible to reduce the maximum speed, and if you wish, the spin cycle can be cancelled.
- If the label does not indicate specific information, it is possible to use the maximum spin expected in the program.

**To prevent damage to the fabrics, it is not possible to increase the speed over the maximum allowed for the programme.**

- To reactivate the spin cycle press the button until you reach the spin speed you would like to set.
- It is possible to modify the spin speed without pausing the machine.

**An over dosing of detergent can cause excessive foaming. If the appliance detects the presence of excessive foam, it may exclude the spinning phase or extend the duration of the program and increase water consumption.**

**The machine is fitted with a special electronic device, which prevents the spin cycle should the load be unbalanced. This reduces the noise and vibration in the machine and so prolongs the life of your machine.**

## DELAY START button

- This button allows you to pre-programme the wash cycle to delay the start of the cycle for up to **24 hours**.
- To delay the start use the following procedure:
  - Select the required programme.
  - Press the button once to activate the delay start and then press it again (or hold it) to set the desired delay. The delay increases each time the button is pressed up to **24 hours**, at which point pressing the button again will reset the delay start to zero.
  - Confirm by pressing the **START/PAUSE** button. The delay countdown will begin and when it has finished the programme will start automatically.

- It is possible to cancel the delay start by turning the programme selector to **OFF**.

*If there is a break in the power supply whilst the machine is operating, when the power is restored, the machine will restart from the beginning of the phase it was in when the power was lost.*

**The option buttons should be selected before pressing the START/PAUSE button.**

## RAPID / STAIN LEVEL button

This button allows you to choose between two different options, depending on the selected programme.

### - RAPID

The button becomes active when you select the **RAPID CARE (14'/30'/44')** programme on the knob and allows you to select one of three durations indicated.

### - STAIN LEVEL

- Once the programme has been selected the wash time set for that programme will be automatically shown.
- This option allows you to choose between 3 levels of wash intensity modifying the length of the programme, depending on how much the fabrics are soiled (can only be used on some programmes as shown in the table of programmes).

## OPTIONS button

This button allows you to choose between three different options:

### - PREWASH

- This option allows you to make a prewash and it is particularly useful for heavily soiled loads (can be used only on some programmes as shown in the table of programmes).

If the detergent Autodose system is off, to make a prewash, you need to pour the powder detergent directly into the drum. In this case, it is suggested to use only the 20% of the quantity reported on the detergent package.

#### - EXTRA RINSE

- This option allows you to add one rinse at the end of the washing cycle and is useful for people with delicate and sensitive skin, for which a small amount of detergent residue can cause irritations or allergies.
- It is advisable to also use this function for the children clothes and for the washing of heavily soiled items, which requires a lot of detergent to be used, or for the washing of toweling items whose fibres mostly have the tendency to hold the detergent.

#### - STEAM

- By this option you can add a specific steam treatment to some washing cycles (see programme table).
- The steam function relaxes the folds and makes ironing times shorter.
- Fibres are regenerated and refreshed, removing all smells from the items.
- A dedicated steam treatment was devised for each programme, to guarantee washing top efficiency depending on item fabrics and colours.

If an option is selected that is not compatible with the selected programme then the option indicator light first flashes and then goes off.

## CARE DOSE BUTTON (AUTODOSE SYSTEM)

**SOME MODELS** are provided with the automatic dosage, that carries out a precise dosage of detergent and softener, up to 20 washing cycles\*, providing a perfect cleaning of your garments. This way water and energy wastes are reduced, as the right detergent and softener quantities are perfectly to the milligram dosed, according to the type of garment, to the weight of the clothes and to the water hardness.

\* Estimate based on a medium load and a low water hardness level.

The drawer is divided into three compartment, as indicated in the **figure**:

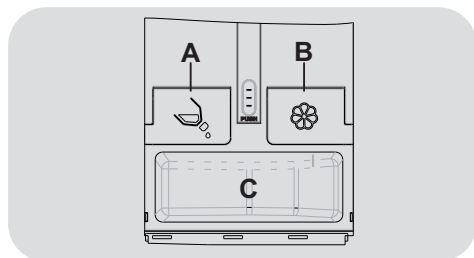

**A** = for LIQUID washing detergent

**B** = for softener

**C = NO AUTOMATIC DOSING:** for powder detergent or liquid detergent with the specific tray provided.



### WARNING:

The automatic dosing system can only be used with LIQUID softeners and detergents. IT IS FORBIDDEN to use powder detergents or other additives.

Before using concentrated softeners, dilute them according to the manufacturer's instructions on the package.

The default setting for the autodose system is set in the factory to carry out both the detergent and softener autodose.

● Pressing the **CARE DOSE** button you will be able to set the autodose function, according to your needs.

● If you want to change the factory settings, press **CARE DOSE** button. Afterward, you can choose the desired setting:

- Pressing **once** the **CARE DOSE** button, the **ONLY** softener autodose will be **deselected**.

- Pressing **twice** the **CARE DOSE** button, both the detergent and softener autodose will be **deselected**.

- Pressing **three times** the **CARE DOSE** button, the **ONLY** detergent autodose will be **deselected**.

- Pressing **four times** the **CARE DOSE** button to go back to the factory settings (both the detergent and softener autodose are ON).

● **ACTIVE WASH** is designed for reduced loads and lightly soiled garments, aiming to limit the unnecessary waste.

**- NIGHT & DAY**

● This option reduces the intermediate spin speed to 400 rpm, where applicable, increase the water level during rinsing and keep the laundry immersed in water after the final rinse, in order to spread the fiber perfectly.

● During the drum water retention phase, the machine is in pause mode.

● Press **START** to end the cycle with the spin (which can be reduced or removed with the specific button) and drain phase.

● Thanks to electronic control, the water in the intermediate phases is emptied silently, making this option very useful for washing at night.

**- DRUM CLEAN**

● Developed to clean the washing machine drum.

● Use only powder detergent.

● Do not start the programme with laundry in the washing machine.

● It is suggested that this is carried out after every 50 washing cycles.

● The option can only be selected for the **DRAIN & SPIN** programme.

 **WARNING:**  
It is necessary to clean the drawer every time it is filled or the type of detergent and softener is changed.  
  
The drawer **MUST REMAIN CLOSED** during the entire wash cycle, otherwise the dosing may not work properly or water may leak.

**SPECIAL PROGRAMMES button**

This button allows you to choose between **three** different options (**available for some programmes only**):

**- ACTIVE WASH**

● This option (which can be set in several programs) optimizes the water and energy consumption of the selected program, maintaining the washing performance unchanged.

**These options must be selected before pressing the START/PAUSE button.**  
**If an option is selected that is not compatible with the selected programme then the option indicator light first flashes and then goes off.**

## CHILD LOCK

- Pressing simultaneously the buttons "**B**" and "**C**" for about **3 seconds**, the machine allows you to lock the keys. In this way, you can avoid making accidental or unwanted changes if a button on the display is pressed accidentally during a cycle.
- The key lock can be simply cancelled by pressing the two buttons simultaneously again or turning off the appliance.

## Digital Display

The display's indicator system allows you to be constantly informed about the status of the machine.

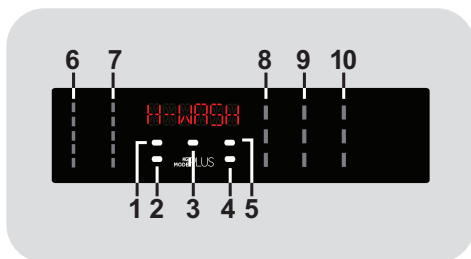

### 1) DOOR LOCKED INDICATOR LIGHT

- The indicator light is illuminated when the door is fully closed.

**Close the door BEFORE selecting the START/PAUSE button.**

- When **START/PAUSE** is pressed on the machine with the door closed, the indicator will flash momentarily and then illuminate.

**If the door is not properly closed, the light will continue to flash for about 7 seconds, after which the start command will be automatically cancelled. In this case, close the door in the proper way and press the START/PAUSE button.**

- A special safety device prevents the door from being opened immediately after the end of the cycle. Wait for **2 minutes** after the wash cycle has finished and the **DOOR LOCKED** light has gone out before opening the door. At the end of the cycle turn the programme selector to **OFF**.

### 2) KEY LOCK INDICATOR LIGHT

The indicator light shows that the keys are locked.

### 3) Kg Mode PLUS INDICATOR LIGHT (function active only on Cotton and Synthetics programmes)

- During the first minutes of the cycle, the "**Kg Mode PLUS**" indicator will remain on while the intelligent sensor will weigh the laundry and adjust the cycle time, water and electricity consumption accordingly.
- Through every wash phase "**Kg Mode PLUS**" allows to monitor information on the wash load in the drum and in the first minutes of the wash it:
  - adjusts the amount of water required;
  - determines the length of the wash cycle;
  - controls rinsing according to the type of fabric selected to be washed it;
  - adjusts the rhythm of drum rotation for the type of fabric being washed;
  - recognises the presence of too much soap suds, and if necessary, adjust the amount of rinse water.
  - adjusts the spin speed according to the load, thus avoiding any imbalance

### 4) Wi-Fi INDICATOR LIGHT

- On models equipped with Wi-Fi, it indicates the status of the connection. It could be:
  - **FIXED ON:** remote control enabled.

- **SLOW FLASHING:** remote control disabled.

- **QUICK FLASHING FOR 3 SECONDS, THEN OFF:** the machine cannot connect to the home Wi-Fi network or has not yet been enrolled on the App.

- **SLOW BLINKING FOR 3 TIMES, THEN OFF FOR 2 SECONDS:** reset of the Wi-Fi network (during enrollment on the App).

- **ON FOR 1 SECOND, THEN OFF FOR 3 SECONDS:** the door is open. Remote control cannot be activated.

**5) STAIN LEVEL INDICATOR LIGHT**

The indicator light shows the selection of the relevant option.

**6) WASH TEMPERATURE INDICATOR LIGHTS**

This show the washing temperature of the selected programme that can be changed

(where allowed) by the relevant button. If you want carry out a cold wash all the indicators must be off.

**7) SPIN SPEED INDICATOR LIGHTS**

This show the spin speed of the selected programme, you can reduce or omit by the relevant button.

**8) OPTIONS INDICATOR LIGHTS**

The indicator lights show the options that can be selected by the relevant button.













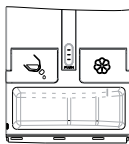





**9) AUTODOSE INDICATORS (CARE DOSE)**

They indicate the activation of the detergent and/or softener autodose. **If the detergent and/or softener have reached the minimum level in the tank, the corresponding lights will flash. It will however still be possible to complete a number of washing cycles.**

**10) SPECIAL PROGRAMMES INDICATOR LIGHTS**

The indicator lights show the options that can be selected by the relevant button.

## Table of programmes

 <b>PROGRAMME</b>		 (MAX.) * (see control panel)								 °C (MAX.)		
		7 kg	8 kg	9 kg	10 kg	11 kg	12 kg	13 kg	14 kg			
	<b>COTTONS</b> <sup>2)</sup> / <sub>4)</sub>	7	8	9	10	11	12	13	14	90°	<input type="checkbox"/>	<input type="checkbox"/>
<b>ECO</b> 40-60	<b>ECO 40-60</b> <sup>2)</sup>	7	8	9	10	11	12	13	14	60°	<input type="checkbox"/>	<input type="checkbox"/>
	<b>WOOL &amp; HAND WASH</b>	1	2	2	2	2	2,5	2,5	2,5	30°	<input type="checkbox"/>	<input type="checkbox"/>
	<b>20°C</b> <sup>2)</sup> / <sub>4)</sub>	7	8	9	10	11	12	13	14	20°	<input type="checkbox"/>	<input type="checkbox"/>
	<b>SYNTHETIC AND COLOURED</b> <sup>2)</sup> / <sub>4)</sub>	3,5	4	4,5	5	5,5	6	6,5	7	60°	<input type="checkbox"/>	<input type="checkbox"/>
	<b>DRAIN &amp; SPIN</b>	-	-	-	-	-	-	-	-	-	<input type="checkbox"/>	<input type="checkbox"/>
	<b>RINSE</b>	-	-	-	-	-	-	-	-	-	<input type="checkbox"/>	<input type="checkbox"/>
	<b>FITNESS CARE</b>	2,5	2,5	2,5	2,5	3	3	3,5	3,5	30°	<input type="checkbox"/>	<input type="checkbox"/>
	<b>SOFT CARE</b> <sup>4)</sup>	2,5	2,5	2,5	2,5	3	3	3,5	3,5	40°	<input type="checkbox"/>	<input type="checkbox"/>
	<b>FRESH CARE</b> <sup>4)</sup>	2,5	2,5	2,5	2,5	3	3	3,5	3,5	40°	<input type="checkbox"/>	<input type="checkbox"/>
	<b>ALLERGY CARE 60°</b>	2	2	2	2	3	3	3,5	3,5	60°	<input type="checkbox"/>	<input type="checkbox"/>
 14'/30'/44'	<b>14'</b>	1	1,5	1,5	1,5	1,5	2	2	2	30°	<input type="checkbox"/>	<input type="checkbox"/>
	<b>30'</b>	2,5	2,5	2,5	2,5	2,5	3	3	3	30°	<input type="checkbox"/>	<input type="checkbox"/>
	<b>44'</b>	3,5	3,5	3,5	3,5	3,5	4	4	4	40°	<input type="checkbox"/>	<input type="checkbox"/>
	<b>ALL IN ONE 59'</b>	7	8	9	10	11	12	13	14	40°	<input type="checkbox"/>	<input type="checkbox"/>
	<b>TOTAL CARE</b>	4,5	5,5	6	6,5	7	8	8	9	30°	<input type="checkbox"/>	<input type="checkbox"/>
	<b>REMOTE CONTROL (Wi-Fi)</b> Position that you have to select when you want to enable remote control through the App (via Wi-Fi).											



**Please read these notes:**

\* Maximum load capacity of dry clothes, according to the model used (see control panel).

**△ (Only for models with liquid detergent compartment)**

When only a limited number of articles have stains which require treatment with liquid bleaching agents, preliminary removal of stain can be carried out in the washing machine.

Pour the bleach into the liquid bleach container, inserted into the compartment marked "2" in the detergent drawer, and set the special programme RINSE.

When this phase has terminated, switch off the appliance, add the rest of the fabrics and proceed with a normal wash on the most suitable programme.

- Programmes with PREWASH option available.
- 1) When a programme is selected, on the display is shown the display shows the recommended wash temperature that can be reduced (where allowed) by the relevant button.
- 2) For the programmes shown you can adjust the duration and intensity of the wash using the STAIN LEVEL button.
- 3) Selecting the CARE programme on the knob, it will be possible to select with the RAPID CARE button, one of the three rapid programmes available among 14', 30' and 44'.
- 4) Steam function available.

**INFORMATION FOR THE TEST LABORATORIES**

**STANDARD PROGRAMMES  
ACCORDING TO  
(EU) No 1015/2010 e No 1061/2010**

**ECO 40-60 PROGRAMME  
SETTING THE TEMPERATURE TO  
40°C**

**ECO 40-60 PROGRAMME  
SETTING THE TEMPERATURE TO  
60°C**

---

**STANDARD PROGRAMME  
ACCORDING TO  
(EU) No 2019/2023**

**ECO 40-60 PROGRAMME**

## Description of programmes

To clean different types of fabrics and various levels of dirt, the washing machine has specific programs to meet every need of washing (see table of programmes).

Choose programme in accordance with the laundry instructions appearing on labels, especially the maximum recommended temperature.



### **WARNING:**

#### **IMPORTANT WASH PERFORMANCE ADVICE.**

- **New, coloured garments should be washed separately for at least 5 or 6 washes.**
- **Certain large dark items such as jeans and towels should always be washed separately.**
- **Never mix NON COLOURFAST fabrics.**

### **REMOTE CONTROL (Wi-Fi)**

Position that you have to select when you want to enable / disable remote control through the App, via Wi-Fi. In this case, the start of cycle will take place through the App commands. More details in the **REMOTE CONTROL (Wi-Fi)** section.

### **COTTONS**

This programme is suitable for washing coloured cotton garments at 40°C or for ensuring the highest degree of cleanliness for cotton resistant laundry washing at 60°C or 90°C. The final spin is at maximum speed that ensures excellent water removal.

### **ECO 40-60**

The **ECO 40-60** programme is able to clean normally soiled cotton laundry declared to be washable at 40°C or 60°C, together in the same cycle. This programme is used to assess the compliance with the EU Ecodesign legislation (environmentally friendly products design).

### **WOOL & HAND WASH**

This programme performs a wash cycle dedicated to the wool fabrics that can be washed in a washing machine, the articles to be washed by hand or laundry items made from silk or specified as "Wash as Silk" on the fabric label.

**If the detergent loaded in the automatic dosing system is not specific for WOOL, it is recommended, for optimal performance and garment protection, to disable the automatic dosing and load a dose of specific detergent directly into the tray.**

### **20°C**

This innovative programme, allows you to wash different fabrics and colours together, such as cottons, synthetics and mixed fabrics at only 20°C and provides an excellent cleaning performance. Consumption on this program is about 40% of a conventional 40°C cottons wash.

### **SYNTHETIC AND COLOURED**

This programme allows you to wash different fabrics and different colours all together. The rotation movement of the drum and the water levels are optimized, both during the washing the rinsing phase. The accurate spin action, ensures a reduced formation of creases in the fabrics.

### **DRAIN & SPIN**

The program completes the drain and a maximum spin. It is possible to delete or reduce the spin through the **SPIN SELECTION** button.

### **RINSE**

This program performs 3 rinses with an intermediate spin (which can be reduced or excluded by using the appropriate button). It is used for rinsing any type of fabric, for example after a wash carried out by hand.

### **FITNESS CARE**

The perfect combination of time and performance. Created to eliminate dirt from athletic garments and sportswear. A low temperature wash recommended for small loads of synthetic items.

**SOFT CARE**

Developed to take good care of delicate items, this programme washes at a low temperature in 59 minutes. An extended, in-depth rinse nourishes fabric fibres.

**FRESH CARE**

This programme is designed to remove everyday stains with a refreshing action to guarantee outstanding laundry. Low temperature wash recommended for small loads.

**ALLERGY CARE 60°**

This programme offers thorough cleaning of all cotton items, sanitising and eliminating bacteria. It is an efficient high temperature washing cycle. Recommended for small loads.

**RAPID CARE (14'-30'-44')**

Saving without compromising! This new programme may be used to obtain excellent results while saving water, energy, detergent and time. This option washes at a medium

temperature suitable for any kind of fabric. Recommended for small loads and lightly soiled items.

**ALL IN ONE 59'**

This programme allows you to wash different fabrics together such as cottons, synthetics and mixed fabrics in only 59 minutes, using the full load of the washing machine, at 40°C (or less) temperature. This programme is particularly suited to slightly dirty fabrics.

**TOTAL CARE**

This new programme may be used to wash laundry of different colourfast colours and fabrics together without altering their original look and feel.

New **POWER CARE** technology uses a perfect emulsion of water and detergent to take the best possible care of your clothes, with optimal washing performance at a temperature of 30°C.

## 10. TROUBLESHOOTING AND WARRANTY

If you believe the washing machine is not working correctly, consult the quick guide provided below which includes some practical tips on how to fix the most common problems.

### ERROR CODE FORMAT

- **Models with a display:** the error is shown by a number preceded by the letter “E” (example: E2 = Error 2).
- **Models without display:** an error is shown by a sequence of flashes of every LED. The error code is shown by the number of flashes followed by a pause of 5 seconds (example: two flashes – pause 5 seconds – two flashes – repeating = Error 2).

<b>Error shown</b>	<b>Possible causes and practical solutions</b>
<b>E2 (with display)</b> <b>2 flashes of the LEDs</b> <i>(without display)</i>	<b>The machine cannot load water.</b>
	Make sure the water supply tap is open.
	Make sure the water supply hose isn't bent, kinked or trapped.
	Make sure the drain pipe is at the proper height (see installation section).
	Close the water supply tap, unscrew the filler hose from the back of the washing machine and make sure the “anti-sand” filter is clean and not blocked.
<b>E3 (with display)</b> <b>3 flashes of the LEDs</b> <i>(without display)</i>	Check that the filter is not clogged or that there are no foreign bodies inside the filter compartment that can obstruct the proper flow of water.
	<b>The washing machine does not drain water.</b>
	Check that the filter is not clogged or that there are no foreign bodies inside the filter compartment that can obstruct the proper flow of water.
	Make sure the drain hose isn't bent, kinked or trapped.
<b>E4 (with display)</b> <b>4 flashes of the LEDs</b> <i>(without display)</i>	Make sure the home drainage system is not blocked and is allowing water to flow through without obstruction. Try to drain the water in the sink.
	<b>There is too much foam and/or water.</b>
<b>E7 (with display)</b> <b>7 flashes of the LEDs</b> <i>(without display)</i>	Ensure the correct amount of detergent is being used and the detergent is designed for use in a washing machine.
	<b>Door problem.</b>
	Make sure the door is correctly closed.
<b>Any other code</b>	Make sure the clothes inside the drum are not preventing the door from closing fully.
	If the door is locked, turn off and unplug the washing machine from the electrical supply socket, wait 2-3 minutes and reopen the door.
	Turn off and unplug the washing machine, wait a minute. Turn on the machine and restart a program. If the error occurs again contact an Authorised Customer Service Centre directly.

## OTHER ANOMALIES

EN

Problem	Possible causes and practical solutions
<p><b><i>The washing machine does not work / start</i></b></p>	Make sure the product is plugged into a working supply socket.
	Make sure power is on.
	Make sure the wall socket is working, testing it with another appliance such as a lamp.
	The door may not be correctly closed: open and close it again.
	Check whether the required program was correctly selected and the start button pressed.
<p><b><i>Water leaked on the floor near the washing machine</i></b></p>	Make sure the washing machine is not in pause or time delay mode.
	This may be due to a leak from the seal between the tap, supply hose and fill valve; in this case, replace it and tighten the hose connections correctly.
<p><b><i>The washing machine does not spin</i></b></p>	Make sure the front filter is correctly closed.
	<p>The machine is fitted with a detection system that protects the load and product from damage if the load is not balanced before spinning. This may result in:-</p> <ul style="list-style-type: none"> <li>• The machine attempts to balance the load, increasing the time of spin.</li> <li>• Reduction of the speed of spin to decrease vibrations and noise.</li> <li>• The spin cycle aborting to protect the machine and load.</li> </ul> <p>If this is experienced remove the load de-tangle it, reload it and restart the spin program.</p>
	This could be due to the fact that water has not been completely drained: wait a few minutes. If the problem persists, see Error 3 section.
	Some models include a "no spin" function: make sure it is not selected.
	Check which options are selected and their effect on the spin cycle.
<p><b><i>Strong vibrations / noises are heard during the spin cycle</i></b></p>	Excessive detergent can impede the spin cycle, ensure the correct amount of detergent is being used.
	The washing machine may not be fully levelled: if necessary, adjust the feet as indicated in the specific section.
	Make sure transport screws, rubber bungs and spacer tubes were removed.
Make sure there are no foreign objects inside the drum (coins, hinges, buttons, etc...).	

**The standard manufacturer warranty covers faults caused by electrical or mechanical faults in the product due to an act or omission of the manufacturer. If a fault is found to be caused by factors outside the product supplied, miss-use or as a result of the instructions on use not being followed, a charge may be applied.**

It is always recommended to use original spare parts, that are available at our Authorised Customer Service Centres.

### **Warranty**

The product is guaranteed under the terms and conditions stated on the certificate included with the product. The certificate has to be stored so as to be shown to the Authorized Customer Service Centre in case of need. You can also check the warranty conditions on our web site. To obtain assistance, please fill in the form on-line or contact us at the number indicated on the support page of our web site.

By placing the **CE** mark on this product, we are confirming compliance to all relevant European safety, health and environmental requirements which are applicable in legislation for this product.

**The manufacturer declines all responsibility for any printing errors in the booklet included with this product. Moreover, it also reserves the right to make any changes deemed useful to its products without changing their essential characteristics.**



