

EN



Thank you for purchasing a Haier Product.

Please read these instructions carefully before using this appliance. The instructions contain important information which will help you get the best out of the appliance and ensure safe and proper installation, use and maintenance.

Keep this manual in a convenient place so you can always refer to it for the safe and proper use of the appliance.

If you sell the appliance, give it away, or leave it behind when you move house, make sure you also pass this manual so that the new owner can become familiar with the appliance and safety warnings.



Legend

Warning – Important Safety information



General information and tips



Environmental information



Note: FOR U.K. ONLY

On receipt of your appliance please check it carefully for damage. Any damage found must be reported to the delivery driver immediately. Alternatively damage found must be reported to the retailer within 2 days of receipt.

Environmental conditions

This appliance is marked according to the European directive 2012/19/EU on Waste Electrical and Electronic Equipment (WEEE).

WEEE contains both polluting substances (which can cause negative consequences for the environment) and basic components (which can be reused). It is important to have WEEE subjected to specific treatments, in order to remove and dispose properly all pollutants, and recover and recycle all materials. Individuals can play an important role in ensuring that WEEE does not become an environmental issue; it is essential to follow some basic rules:

- WEEE should not be treated as household waste;
- WEEE should be handed over to the relevant collection points managed by the municipality or by registered companies. In many countries, for large WEEE, home collection could be present. In many countries, when you buy a new appliance, the old one may be returned to the retailer who has to collect it free of charge on a one-to-one basis, as long as the equipment is of equivalent type and has the same functions as the supplied equipment.



WARNING!

Risk of injury or suffocation!

Disconnect the appliance from the mains supply. Cut off the mains cable and dispose of it. Remove the door catch to prevent children and pets to get closed in the appliance.

1-Safety information.....	4
2-Installation.....	7
3-Practical hints.....	11
4-Product description.....	13
5-Control panel.....	14
6-Programmes.....	21
7-Consumption.....	24
8-Daily use.....	25
9-Remote Control (WI-FI).....	30
10-Care and cleaning.....	32
11-Troubleshooting.....	35
12-Technical data.....	38
13-Customer service.....	39



Download the
hOn App



GET IT ON
Google play

EXPLORE IT ON
AppGallery

Before switching on the appliance for the first time read the following safety hints!:



WARNING!

Daily use

- ▶ This appliance is intended to be used in household and similar applications such as:
 - Staff kitchen areas in shops, offices and other working environments;
 - Farmhouses;
 - By clients in hotels, motels and other residential type environments;
 - Bed and breakfast type environments.

A different use of this appliance from household environment or from typical housekeeping functions, as commercial use by expert or trained users, is excluded even in the above applications. If the appliance is used in a manner inconsistent with this it may reduce the life of the appliance and may void the manufacturer's warranty. Any damage to the appliance or other damage or loss arising through use that is not consistent with domestic or household use (even if located in a domestic or household environment) shall not be accepted by the manufacturer to the fullest extent permitted by law.

- ▶ This appliance can be used by children aged from 8 years and above and persons with reduced physical, sensory or mental capabilities or lack of experience and knowledge if they have been given supervision or instruction concerning use of the appliance in a safe way and understand the hazards involved. Children shall not play with the appliance. Cleaning and user maintenance shall not be made by children without supervision.
- ▶ Children should be supervised to ensure that they do not play with the appliance.
- ▶ Children of less than 3 years should be kept away unless continuously supervised.
- ▶ If the supply cord is damaged, it must be replaced by a special cord or assembly available from the manufacturer or its service agent.
- ▶ Only use the hose-sets supplied with the appliance for the water supply connection (do not reuse old hose-sets).
- ▶ Water pressure must be between 0.03 MPa and 1 MPa.

**WARNING!**

- ▶ Make sure carpets or rugs do not obstruct the base or any of the ventilation openings.
- ▶ After installation, the appliance must be positioned so that the plug is accessible.
- ▶ The maximum load capacity of dry clothes depends on the model used (see control panel).
- ▶ To consult the product technical specification please refer to the manufacturer website.

Electrical connections and safety instructions

- ▶ The technical details (supply voltage and power input) are indicated on the product rating plate.
- ▶ Make sure that the electrical system is earthed, complies with all applicable law and that the (electricity) socket is compatible with the plug of the appliance. Otherwise, seek qualified professional assistance.
- ▶ The use of converters, multiple sockets or extension cords is strongly advised against.
- ▶ Before cleaning or maintaining the washing machine, unplug the appliance and turn off the water tap.
- ▶ Do not pull on the power cord or appliance to unplug the machine.
- ▶ Make sure there is no water in the drum before opening the door.

**WARNING!****Water may reach very high temperatures during the wash cycle.**

- ▶ Do not expose the washing machine to rain, direct sunlight or other weather elements. Protect from possible freezing.
- ▶ When moving, do not lift the washing machine by the knobs or detergent drawer; during transport, never rest the door on the trolley. We recommend two people lift the washing machine.
- ▶ In the event of fault and/or malfunction, turn off the washing machine, close the water tap and do not tamper with the appliance. Immediately contact the customer service centre and only use original spare parts. Failure to observe these instructions may jeopardise appliance safety.

Intended use

This appliance is intended for washing machine-washable laundry only. Anytime follow the instructions given on the label of each garment label. It is designed exclusively for domestic use inside the house. It is not intended for commercial or industrial use.

Changes or modifications to the device are not allowed. Unintended use may cause hazards and loss of of all warranty and liability claims.

2.1 Preparation

- ▶ Make sure there is no transport damage.
- ▶ Make sure all transport bolts are removed.
- ▶ Handle the appliance always with at least two persons because it is heavy.
- ▶ Take the appliance out of the packaging.
- ▶ Remove all packaging material including protecting film on cabinet, polystyrene base, keep them out of children reach. While opening the package, water drops may be seen on plastic bag and porthole. This normal phenomenon results from water tests in the factory.



Note: Packaging disposal

Keep all packaging materials out of children's reach and dispose them in an environmentally friendly manner.

2.2 OPTIONAL: Install noise reduction pads

1. When opening the shrink package, you will find some noise reduction pads. These are used for reducing noise. (Fig. 2-1)
2. Lay the washing machine down to its side, porthole pointing upwards, bottom side towards operator.
3. Take out the noise reduction pads and remove the double-sided adhesive protective film; paste around the bottom; the noise reduction pads under the washing machine cabinet as shown in Figure 3. (two longer pads in position 1 and 3, two shorter pads in position 2 and 4). Finally set the machine upright again.

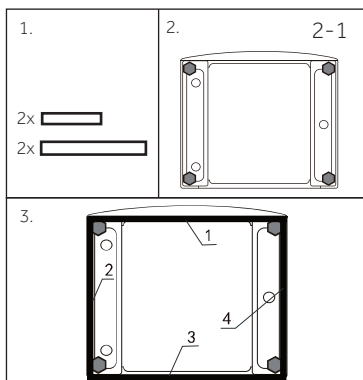

2.3 Dismantle the transportation bolts

The transport protection on the rear side is designed for clamping anti-vibration components inside the appliance during transportation to prevent inner damage. All elements (T1, T2, T3 and T4, Fig 2-2) must be removed before use.

1. Remove all 4 bolts (T1 - T4) (Fig. 2-3).
2. Fill the 5 holes with blanking plugs.
Please note: for 8kg models, please fill the 4 holes with blanking plugs.

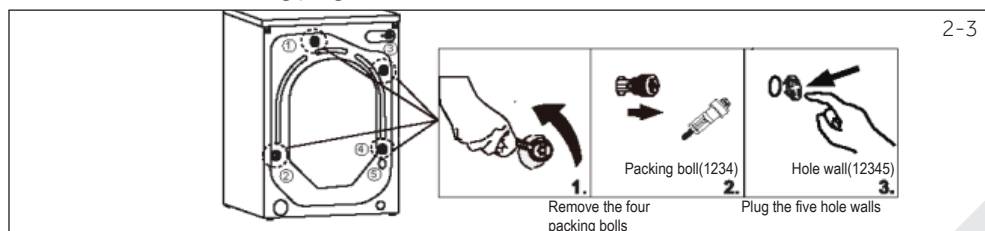
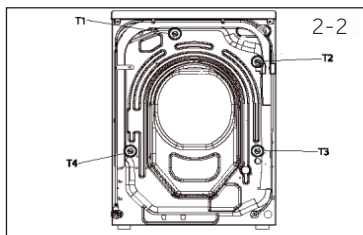

Note: Keep in safe place

Keep the transportation bolts in a safe place for later use. Whenever the appliance is to be moved at first reinstall the bolts.

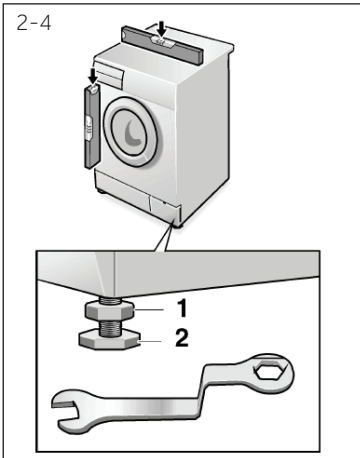

2.4 Moving the appliance

If the machine is to be moved to a distant location, replace the transportation bolts removed before installation to prevent damage. The assembly takes place in reverse order.

2.5 Aligning the appliance

Adjust all feet (Fig. 2-4) to achieve a complete level position. This will minimize vibrations and thus noise during use. It will also reduce wear and tear. We recommend to use a spirit level for adjustment. Floor should be as stable and flat as possible.

1. Loose the locknut (1) by using a wrench.
2. Adjust the high by turning the foot (2).
3. Tighten lock ut (1) against the housing.

2.6 Drain Water Connection

Fix the water drain hose properly to the piping. The hose has to reach at one point a height between 80 and 100 cm above the appliance bottom line! If possible keep always drain hose fixed to the clip at the appliance back.



WARNING!

- ▶ Use only the supplied hose set for the connection.
- ▶ Never reuse old hose sets!
- ▶ Only connect to cold water supply.
- ▶ Before connection, check whether the water is clean and clear.

Following connections are possible:

2.6.1 Drain hose to sink

- ▶ Hang the drain hose with the U-support over the edge of a sink with adequate size (Fig. 2-5).
- ▶ Protect the U-support sufficiently against slipping.

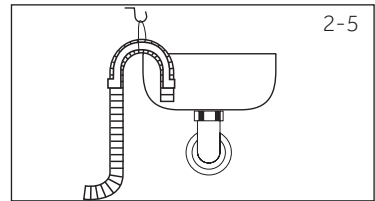

2.6.2 Drain hose to waste water connection

- ▶ The internal diameter of the stand pipe with vent-hole must be minimum 40 mm.
- ▶ Put the drain hose for approx. 80-100 mm in the wastewater pipe.
- ▶ Attach the U-support and secure it sufficiently (Fig. 2-6).

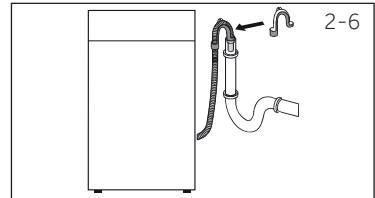

2.6.3 Drain hose to sink connection

- ▶ The junction must lie above the siphon
- ▶ A spigot connection is usually closed by a pad (A). That must be removed to prevent any disfunction (Fig. 2-7).
- ▶ Secure the drain hose with a clamp.

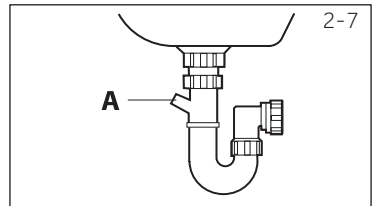

CAUTION!

- ▶ The drain hose should not be submerged in water and should be securely fixed and leak-free. If the drain hose is placed on the ground or if the pipe is at a height of less than 80 cm, the washing machine will continuously drain while being filled (self-siphoning).
- ▶ Drain hose is not to be extended. If necessary contact after sales service.

2.7 Fresh Water Connection

Make sure that the gaskets are inserted.

1. Connect the water inlet hose with the angled end to the appliance (Fig. 2-8). Tighten the screw joint by hand.
2. The other end connect to a water tap with a 3/4" thread (Fig.2-9).

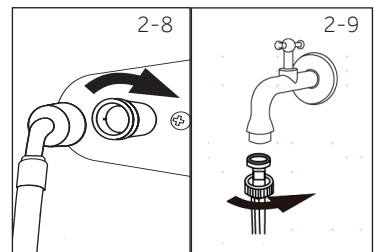

2-10

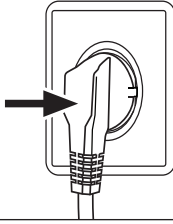

2.8 Electrical Connection

Before each connection check if:

- ▶ power supply, socket and fusing are appropriate to the rating plate.
- ▶ the power socket is earthed and no multi-plug or extension are used.
- ▶ the power plug and socket are strictly according.
- ▶ **Only UK:** The UK plug meets BS1363A standard.

Put the plug into the socket (Fig. 2-10).



WARNING!

- ▶ Ensure always that all connections (power supply, drain and fresh water hose) are firm, dry and leak free!
- ▶ Take care these parts are never to be crushed, kinked, or twisted
- ▶ If the supply cord is damaged, it must be replaced by the service agent (see warranty card) in order to avoid a hazard. .

3.1 Load tips

When sorting laundry, make sure:

- have eliminated metallic objects such as hair clips, pins, coins, from laundry;
- to have buttoned pillow cases, closed zips, tied loose belts and long robe ribbons;
- to have removed rollers, hooks or clips from curtains;
- to have carefully read clothing washing labels;
- to have removed any persistent stains using specific detergents.
- ▶ When washing rugs, bedcovers or other heavy clothing, we recommend you avoid the spinning cycle.
- ▶ To wash wool, make sure the item can be machine washed. Check the fabric label.
- ▶ Leave the appliance's door slightly open between washes, to prevent possible bad smells developing inside the machine.

3.2 Useful advice for saving

Tips on how to save money and not damage the environment when using your appliance.

- ▶ Load the machine with suggested capacity shown in the programme table for each programme - this will allow you to SAVE energy and water.
- ▶ Noise and residual laundry moisture are affected by spin speed: a faster spin is associated with greater noise and lower residual moisture in the laundry.
- ▶ The most efficient programmes in terms of combined use of water and energy are usually the longer-lasting ones with lower temperature.
- ▶ Scan QR code on energy label for energy consumption information. The actual energy consumption may differ from the declared one according to local conditions.

Maximise the load size

- ▶ Achieve the best use of energy, water, detergent and time by using the recommended maximum load size. Save up to 50% energy by washing a full load instead of 2 half loads.

Do you need to pre-wash?

- ▶ For heavily soiled laundry only!
SAVE detergent, time, water and energy consumption by NOT selecting Prewash for slight to normally soiled laundry.

Is a hot wash required?

- ▶ Pretreat stains with stain remover or soak dried in stains in water before washing to reduce the necessity of a hot wash programme. Save energy by using a low temperature wash programme.

3.3 Dosing the detergent

Below is a short guide with tips and advice on the use of detergent

- ▶ Only use detergents suitable for washing machine.
- ▶ Select your detergent according to the type of fabric (cotton, delicates, synthetics, wool, silk, etc.), the colour, the type and level of soiling and the programmed washing temperature.
- ▶ To use the right amount of detergent, softener or any other additives, carefully follow the manufacturer's instructions every time: correctly using the appliance with the right dose allow you to avoid waste and to reduce the environmental impact.



Note: Detergent

When washing heavily soiled whites, we recommend using cotton programs of 60°C or above and a normal washing powder (heavy duty) that contains bleaching agents that at medium/high temperatures provide excellent results.

For washes between 40°C and 60°C the type of detergent used needs to be appropriate for the type of fabric and level of soiling. Normal powders are suitable for "white" or colour fast fabrics with high soiling, while liquid detergents or "colour protecting" powders are suitable for coloured fabrics with light levels of soiling.

For washing at temperatures below 40°C we recommend the use of liquid detergents or detergents specifically labeled as suitable for low temperature washing.

For washing wool or silk, only use detergents specifically formulated for these fabrics.

- ▶ Too much detergent leads to excessive foam, which prevents the cycle being carried out correctly. It could also affect the quality of the washing and rinsing.

The use of ecological detergents without phosphates may cause the following effects:

- **cloudier rinse drain water:** This effect is tied to the suspended zeolites which do not have negative effects on rinse efficiency.
- **white powder (zeolites) on laundry at the end of the wash:** this is normal, the powder is not absorbed by fabric and does not change its colour.
To remove the zeolites, select a rinse programme. In the future consider using slightly less detergent.
- **foam in the water at last rinse:** this does not necessary indicate poor rinsing. Consider using less detergent in future washes.
- **abundant foam:** This is often due to the anionic surfactants found in the detergents which are hard to eliminate from laundry.
In this case, do not re-rinse to eliminate these effects: it will not help at all. We suggest conducting a maintenance wash using a proprietary cleaner. If the problem persists or if you suspect a malfunction, immediately contact an Authorised Customer Service Centre.

Note: Deviations

Due to technical changes and different models, the illustrations in the following chapters may differ from your model.

4.1 Picture of appliance

Front (Fig. 4-1):

Rear side (Fig. 4-2):

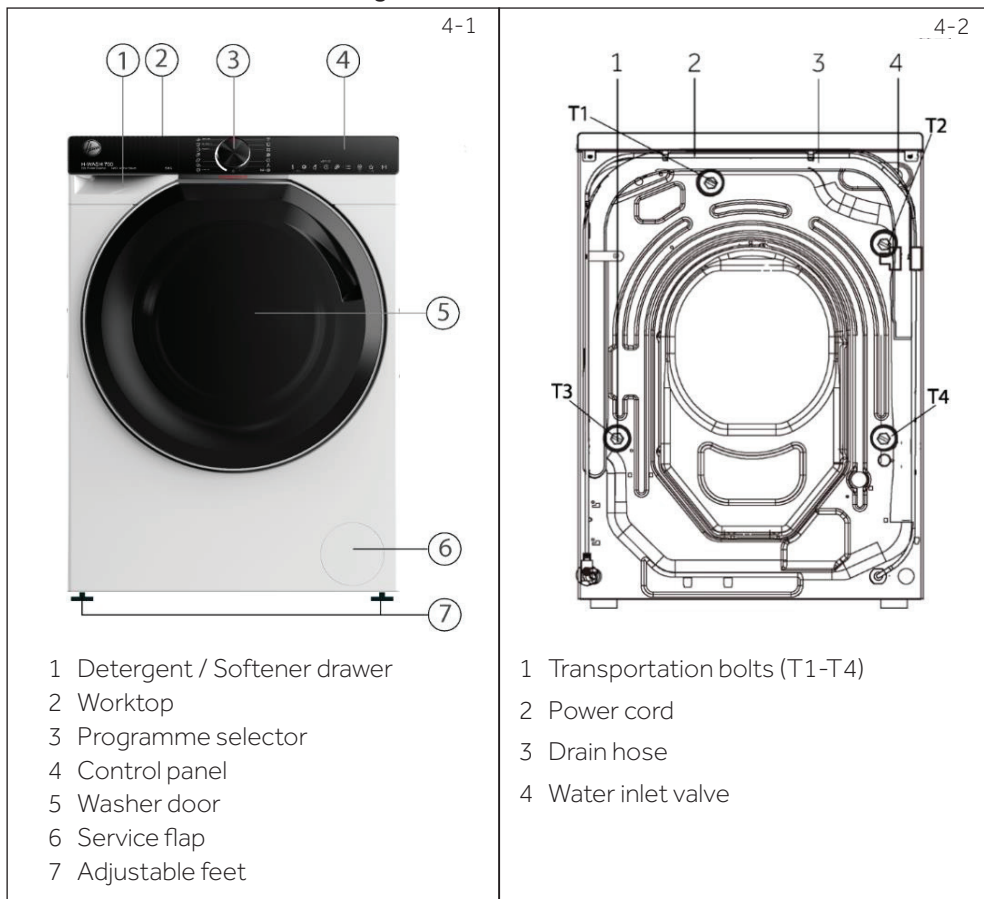

4.2 Accessories

Check the accessories and literature in accordance with this list (Fig. 4-3):

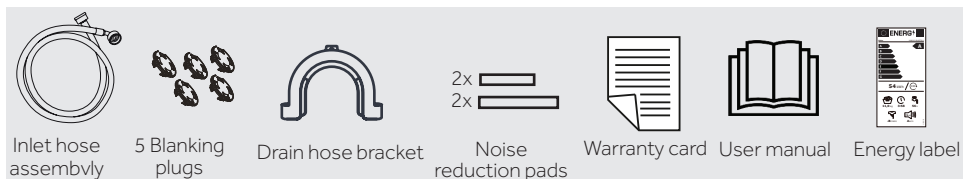

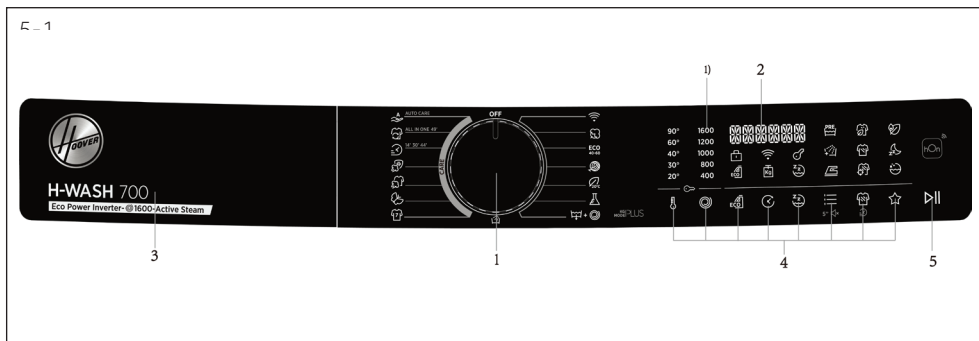

- 1 Programme selector 3 Detergent/Softener drawer 4 Function buttons
 2 Display 5 "Start/Pause" button

i Note: Acoustic signal

The acoustic signal can be selected if necessary: see DAILY USE (P29, 8.13)

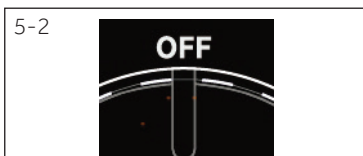

5.1 OFF

Turn the knob to any position (except OFF) to start the machine. Turn the knob to the OFF position to shut down the machine (Fig.5-2).

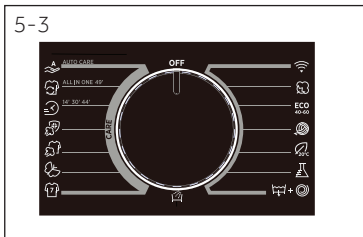

5.2 Programme selector

By turning the knob (Fig.5-3) one of 15 programmes can be selected, its default settings will be displayed.

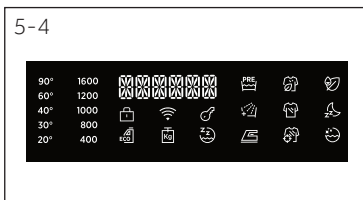

5.3 Display

The display (Fig. 5-4) shows following information:

- ▶ Program name
- ▶ Remaining time
- ▶ Reservation remaining time
- ▶ Alarm information and prompt information
- ▶ Pause end information
- ▶ Delay time

1)1600 rpm:H7W 610*/H7W 69*;
 1400 rpm:H7W 412*/H7W 4105*/H7W 449*/H7W 448*.

5.4 Detergent drawer

Open dispenser drawer, the following components can be seen (Fig. 5-5):

- 1: Compartment for powder or liquid detergent
- 2: Detergent flap selector, lift it up for powder detergent, keep it down for liquid detergent.
- 3: Put a small amount of washing powder.
- 4: Compartment for softener.
- 5: Lock tab, press it down to pull out dispenser drawer

The recommendation on the type of the detergents is suitable for the various washing temperatures. Please refer to the manual of detergent.

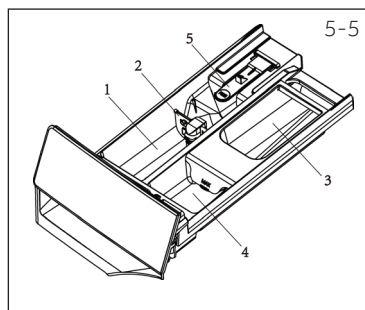

5.5 Function buttons

The function buttons (Fig. 5-6) enable additional options in the selected programme before programme starts. The related indicators are displayed.

The related indicators are displayed.

By switching off the appliance or setting a new programme all options are displayed.

If a button has multiple options, the desired option can be selected by pressing the button sequentially.

By touching the buttons, when it is in dull light, the function is unselected; when it is in bright light, the function is selected.

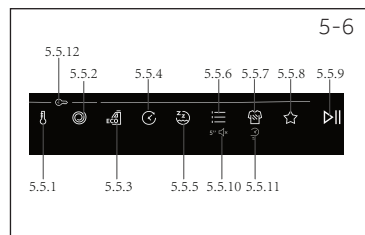

i Note: Factory settings

To get best results in each programme Hoover has well defined specific default settings. If there is no special requirement default settings are recommended.

5.5.1-Function button "🌡️"

Touch this button (Fig.5-7) to change the washing temperature of the programme. If no light is illuminated and display „COLD“, the water will not be heated.

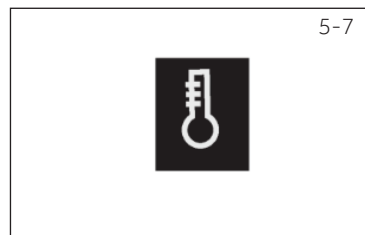

5.5.2 Function button "🌀"

Touch this button (Fig.5-8) to change or deselect the spin of the programme. If no light is illuminated and display "NO SPIN", the laundry will not spin.



5-9



5.5.3 Function button "ECO" "

- Thanks to Eco Doser (Fig.5-9), the appliance is able to suggest the optimal amount of washing detergent to pour into the drawer based on the actual load.
- This smart suggestion can only be activated in certain programmes in the following way:
 - Place the laundry in the drum and close the door.
 - Press the ECO DOS ER button on the layout.
 - Press START/PAUSE. After a while, the display will show the recommended amount of detergent to be used.
 - Pour the detergent into the drawer and press START/PAUSE to start the cycle.

5-10



5.5.4 Function button "⌚" "

- This button (Fig.5-10) allows you to preprogramme the wash cycle to delay the start of the cycle for up to 24 hours.
- To delay the start use the following procedure:
 - Select the required programme.
 - Press the button once to activate the delay start and then press it again to set the desired delay . The delay increases in in steps of 30 minutes, the button is pressed up to 24 hours, at which point pressing the button again will reset the delay start to zero.
 - Confirm by pressing the START/PAUSE button. The delay countdown will begin and when it has finished the programme will start automatically.
- It is possible to cancel the delay start by turning the programme selector other programmes.

5-11



5.5.5 Function button "zz" "

- Select the program that can select this function and the corresponding icon will light up after selection.
- After selecting this program, the noise of spin will be reduced and all beeps except alarm will be cancelled.
- Press this key again to cancel this function.



Note: Speed

After selecting this function,user cannot select speed.But the machine will complete spinning process.

5.5.6 Function button" "

- This button (Fig.5-12) allows you to choose between three different options:
 - **PREWASH**
- This option allows you to make a prewash and it is particularly useful for heavily soiled loads (can be used only on some programmes as shown in the table of programmes).
- We recommend you use no or a small amount of detergent quantities shown on the detergent pack.
 - **EXTRA RINSE**
- This option allows you to add one rinse at the end of the washing cycle and is useful for people with delicate and sensitive skin, for which a small amount of detergent residue can cause irritations or allergies.
- It is advisable to also use this function for the children clothes and for the washing of heavily soiled items, which requires a lot of detergent to be used, or for the washing of toweling items whose fibers mostly have the tendency to hold the detergent.
 - **ANTICREASE**
- This option allows the washing machine keeps intermittent operation after final spin to shake off the clothes to prevent mildew and odor, reduce wrinkles and make them smoother after hanging up.
- Under „ANTICREASE" function, the max. spin speed will decrease. After selecting this function, the user can no longer select the speed. During the operation, the LED display shows „- - - - -" and this phase lasts for 12 hours at most, users can touch „Start / Pause" to terminate the programme at any time.



Note: Options

These options must be selected before pressing the START/PAUSE button.

5.5.7 Function button" "

- This button (Fig.5-13) allows you to choose between three different options, depending on the selected programme:
 - **STAIN LEVEL**
- Once the programme has been selected the wash time set for that programme will be automatically shown.
- This option allows you to choose between 3 levels of wash intensity modifying the length of the programme, depending on how much the fabrics are soiled (can only be used on some programmes as shown in the table of programmes).
 - **RAPID CARE**
- The button becomes active when you select the RAPID CARE (14'/30'/44') programme on the knob and allows you to select one of three durations indicated.



5-14



-STEAM LEVEL

- After selecting the STEAM CARE PRO programme, you can use this button to choose between three steam treatments of different intensities, designed only for dry garments and depending on the type of fabric:
 - **COTTON** (default selection)
This programme is used for cotton garments. The cycle refreshes and relaxes creases in suitable for dry fabrics.
 - **SYNTHETIC** (press button once)
This programme is used for synthetic garments. The cycle refreshes and relaxes creases in garments after use. The cycle is suitable for dry fabrics.
 - **DELICATES** (press button twice)
The cycle is suitable for soft fabrics. The cycle refreshes and relaxes creases in garments after use. The cycle is suitable for dry fabrics.

5.5.8 Function button "★" SPECIAL PROGRAMMES.

Special programmes	max. kg					STD TEMP	MAX TEMP	PRESET SPIN	MAX SPIN				Wash intensity	Ecco doser	Silent mode	Pre wash	Extra rinse	Anti crease	Delay
	8 kg	9 kg	10 kg	10.5 kg	12 kg					1	2	3							
Active wash	1	1	2	2	2	30	30	1000	1000	•	○	/	/	/	/	/	/	/	•
Night & Day	4	4	5	5.5	6	40	60	800	1000	•	○	/	•	•	/	/	•	/	/
Drum clean	-	-	-	-	-	90	90	400	400	/	/	/	/	/	/	/	/	/	/

5-15



- This button (Fig.5-15) allows you to choose between three different options (available for some programmes only):
 - **ACTIVE WASH**
 - ACTIVE WASH is designed for reduced loads and lightly soiled garments, aiming to limit the unnecessary waste.
 - **NIGHT & DAY**
 - Selecting this program will turn off the beep except for the alarm, reduce and the intermediate spin speed.
 - The laundry keep immersed in water after the final rinse, in order to spread the fiber perfectly. During the drum water retention phase, the machine will pause the timing. Press START to end the cycle with the spin and drain phase.
 - **DRUM CLEAN**
 - This program can carry out the self-cleaning of the washing machine.

- We recommend a bucket self-cleaning after using the washing machine for 50 times.
- When using this program, please do not put any clothes detergent or washing machine cleaner.



Note: Options

These options must be selected before pressing the START/PAUSE button. If an option is selected that is not compatible with the selected programme then the option indicator light goes off.

5.5.9 Function button "▶||" 5-16

- Touch this button (Fig.5-16) gently to start or interrupt the currently displayed programme.



5-16

5.5.10 Function button "5" 🔊" 5-17

- In the standby mode after power on, long press the button (Fig.5-17) for more than 5 seconds to turn on or off the sound. The interface will display "SOUND OFF ". Press and hold this key again for more than 5 seconds, and the interface will "SOUND ON".



5-17

5.5.11 Function button "⌚" 5-18

- The button becomes active when you select the RAPID CARE (14'/30'/44') programme on the knob and allows you to select one of three durations indicated.



5-18

5.5.12 Function button "🔑" 5-19

- After selecting a program to start, long press the "temperature" button and "speed" button for 3 seconds to open the child lock (Fig.5-19). "CHILD LOCK ON" will be displayed on the interface. Press and hold the "temperature" button and "speed" button for about 3 seconds to unlock the child lock, and "CHILD LOCK OFF" will be displayed on the interface.
- Child lock can't be set up or cancelled through hOn APP.

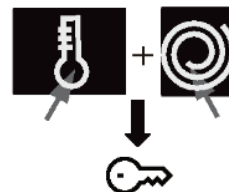

5-19



Note: Child lock

The child lock which is set up manually must be cancelled manually or will be canceled automatically at the end of programme. Power off and error information won't cancel child lock. It still works when the appliance is powered on next time.

5.6 First starting

5.6.1 Language setting

- After connecting the machine to power and turning it on, press the "speed" or "temperature" button to display the available languages.
- Select the desired language pressing the START/ PAUSE button.

5.6.2 Change the language

- If you want to change the setting language you will have to press simultaneously "Delay" and "Option" buttons for about 5 seconds, the language choose last time will appear on display, and you will be able to choose a new language (by pressing button "speed" or "temperature").
- Confirm by pressing the START/PAUSE button.

5.6.3 Choosing the type of detergent used

- Thanks to Eco Doser, the appliance is able to suggest the optimal amount of washing detergent to pour into the drawer based on the actual load.
- In order for the Eco Doser to work properly, it is necessary to select the type of detergent used, choosing between normal or concentrated liquid detergent or powder detergent.
- Press „speed" or "temperature" button to display the available options and press START/ PAUSE to confirm your choice.

5.6.4 Changing the type of detergent used

- If you wish to change the type of detergent used, you will need to press and hold down "Delay" and "Option" buttons simultaneously for about 5 seconds. The display shows the detergent selection option again.
- Press "speed" or "temperature" button to display the available options and press START/ PAUSE to confirm your choice.

5.6.5 Setting the Water hardness level

- In order to make some automatisms of the appliance work correctly, it is necessary to set the Water Hardness level.



Note: Water hardness

The default setting for the water hardness is set in the factory at level 2 (L2) as this satisfies the requirements of the majority of users.

Water Hardness level:

L1 = LOW (0-12 °fH o 0-7 °dH)

L2 = MEDIUM (13-30 °fH o 8-17 °dH)

L3 = HIGH (≥ 30 °fH o ≥ 17 °dH)

- To confirm the standard water hardness level set by the factory, press START/PAUSE button.
- If you want to change the standard water hardness setting, press the "speed" or "temperature" button.
- Once chosen the water hardness level, confirm by pressing the START/PAUSE button.

5.6.6 Changing the Water hardness level setting

- If you wish to change the type of detergent used, it is necessary to first go through the language and type of detergent change menu (and change the language and type of detergent used) by holding down "delay" and "option" buttons simultaneously for about 5 seconds.
- Once you have configured the language (and the type of detergent used) as explained in the dedicated paragraphs, you can select the desired water hardness level using button "speed" or "temperature" button.
- Confirm by pressing the START/PAUSE button.

• Yes, ○ Optional, / No

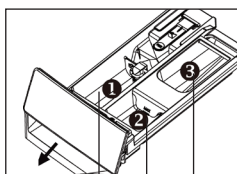

Detergent compartment for:

- 1 Detergent
- 2 Softener or care product
- 3 Prewash¹⁾

	max. kg					STD TEMP	MAX TEMP	PRESET SPIN	MAX SPIN	1	2	3	Wash intensity ²⁾	Ecco doser	Silent mode	Pre wash	Extra rinse	Anti crease	Delay
	8 kg	9 kg	10 kg	10.5 kg	12 kg														
Auto Care	5	6	7	7	8	30	30	1000	1000	•	○	/	•	•	/	/	•	/	•
All In One 49'	8	9	10	10.5	12	40	40	800	MAX	•	○	/	/	•	•	/	•	•	•
Rapid Care 14' Rapid Care 30' Rapid Care 44'	1	1	2	2	2	30	30	800	MAX	•	○	/	•	/	/	/	•	/	•
	2	2	2	2	3	30	30	800	MAX	•	○	/	•	/	/	/	•	/	•
	2	2	3	3	3	40	40	800	MAX	•	○	/	•	/	/	/	•	/	•
AllergyCarePro	4	4	5	5	6	60	60	MAX	MAX	•	○	/	/	/	•	/	/	/	•
SteamCarePro	1	1	2	2	2	-	-	-	-	/	/	/	•	/	/	/	/	/	/
Soft Care	2	2	2	2	3	30	40	400	400	•	○	/	/	/	/	/	/	/	•
Fitness Care	2	2	2	2	3	40	40	800	MAX	•	○	/	/	•	/	/	•	/	•
Rinse	8	9	10	10.5	12	-	-	1000	1000	/	○	/	/	/	/	/	/	/	/
Remote Control (Wifi)	-	-	-	-	-	-	-	-	-	/	/	/	/	/	/	/	/	/	/
Cottons	8	9	10	10.5	12	40	90	MAX	MAX	•	○	○	•	•	•	•	•	•	•
ECO 40-60 Eco 40-60	8	9	10	10.5	12	-	-	MAX	MAX	•	○	/	/	/	/	/	/	/	•
Wool & Hand Wash	2	2	2	2	3	30	30	800	800	•	○	/	/	/	/	/	/	/	•
20°C	8	9	10	10.5	12	20	20	1000	1000	•	○	/	•	•	•	/	•	/	•
Synthetic & Coloured	5	6	7	7	8	40	60	1200	1200	•	○	○	•	•	•	•	•	•	•
Drain & Spin	8	9	10	10.5	12	-	-	1000	MAX	/	/	/	/	/	•	/	/	/	/

INFORMATION FOR THE TEST LABORATORIES STANDARD PROGRAMME ACCORDING TO (EU) No 2019/2023: ECO 40-60 PROGRAMME

¹⁾ A little detergent can be added only with the pre-wash function.

²⁾ This button also for selecting duration of rapid care and different steam intensities as explained in the dedicated paragraphs, but the light is not illuminated.

Description of programmes

To clean different types of fabrics and various levels of dirt, the washing machine has specific programs to meet every need of washing (see table of programmes).



Note: Choosing programme

Choose programme in accordance with the laundry instructions appearing on labels, especially the maximum recommended temperature.



WARNING! IMPORTANT WASH PERFORMANCE ADVICE.

- ▶ New, coloured garments should be washed separately for at least 5 or 6 washes.
- ▶ Certain large dark items such as jeans and towels should always be washed separately.
- ▶ Never mix NON COLOURFAST fabrics.

AUTO CARE

The new POWER CARE technology, through a perfect mix of water and detergent, guarantees the maximum care of your clothes, at a 30°C temperature with a perfect washing performance.

This innovative programme is capable to automatically the cleaning action to the capacity and typology of the load for the best results without any worries.

This program can wash lightly soiled mixed laundry of cotton and synthetic.

ALL IN ONE 49'

This programme allows you to wash different fabrics together such as cottons, synthetics and mixed fabrics in only 49 minutes at 40°C (or less) temperature. This programme is particularly suited to slightly dirty fabrics.

RAPID CARE (14'/30'/44')

Saving without compromising! This new programme may be used to obtain excellent results while saving water, energy, detergent and time. This option washes at a medium temperature suitable for lightly soiled mixed laundry of cotton and synthetic. Recommended for small loads and lightly soiled items.

ALLERGY CARE PRO

This washing programme is capable of reaching a temperature of 60°C for an extended period of time, combining the steam action with a powerful rinsing action for thoroughly clean and hygienic clothing. Recommended for cotton fabrics.

STEAM CARE PRO

This programme uses a steam treatment to relax creases. Three different intensity levels can be selected via the button, designed only for dry garments and depending on the type of fabric.

SOFT CARE

Developed to take good care of delicate items, this programme washes at a low temperature in short time. An extended, in - depth rinse nourishes fabric fibres.

FITNESS CARE

The perfect combination of time and performance. Created to eliminate dirt from athletic garments and sportswear. A low temperature wash recommended for small loads of synthetic items.

RINSE

This program performs 2 rinses with an intermediate spin (which can be reduced or excluded by using the appropriate button). It is used for rinsing any type of fabric, for example after a wash carried out by hand.

REMOTE CONTROL (Wi-Fi)

Position that you have to select when you want to enable / disable remote control through the App, via Wi-Fi. In this case, the start of cycle will take place through the App commands. More details in the REMOTE CONTROL (Wi-Fi) section.

COTTONS

This programme is suitable for washing coloured cotton garments at 40°C or for ensuring the highest degree of cleanliness for cotton resistant laundry washing at 60°C or 90°C. The final spin is at maximum speed that ensures excellent water removal.

ECO 40-60

The ECO 40-60 programme is able to clean normally soiled cotton laundry declared to be washable at 40°C or 60°C, together in the same cycle. This programme is used to assess the compliance with the EU Ecodesign legislation (environmentally friendly products design).

WOOL & HAND WASH

This programme performs a wash cycle dedicated to the wool fabrics that can be washed in a washing machine, the articles to be washed by hand.

20°C

This innovative programme, allows you to wash different fabrics and colours together, such as cottons, synthetics and mixed fabrics at only 20°C and provides an excellent cleaning performance.

SYNTHETIC & COLOURED

This programme allows you to wash different fabrics and different colours all together. The rotation movement of the drum and the water levels are optimized, both during the washing the rinsing phase. The accurate spin action, ensures a reduced formation of creases in the fabrics.

DRAIN & SPIN

The program completes the drain and a maximum spin. It is possible to delete or reduce the spin through the SPIN SELECTION button.



Note: The procedure to check the number of cycle that the machine has run.

Procedure: under standby mode, select "DRAIN & SPIN" programme first, then press "speed" and "delay" at the same time, it will display the number of running cycle for 2 seconds, and then back to standby interface. The cumulative running cycles will add after the programme ends. The running cycles will be displayed in hexadecimal it is over 9999.

7-Consumption





EN

Scan QR code on energy label for energy consumption information. The actual energy consumption may differ from the declared one according to local conditions.

Note: Auto Weight

The appliance is equipped with a loading recognition. At low loading, energy, water and washing time will be reduced automatically in some programmes. The display default time may vary depending on the load weight, involving the "Smart, Synthetic, Cotton, Cotton 20°C, Eco 40-60" programme.

Indicative information(as per Commission Regulation (EU) 2019/2023):

Rated Capacity	Programme	 (kg)	 (HH:MM)	 (kWh/cycle)	 (L/cycle)	Max. Temp.(°C)	Effective Speed (RPM)	 Residual Moisture (%)
8 kg 1400 r	Eco 40-60	8.0	3:38	0.690	60.0	32	1330	53.0
	Eco 40-60	4.0	2:48	0.500	41.0	30	1330	52.0
	Eco 40-60	2.0	2:48	0.210	30.0	25	1330	55.6
	Cotton 20°C	8.0	1:58	0.220	75.0	20	1000	65.0
	Cotton 60°C	8.0	3:03	2.100	75.0	57	1400	53.0
	Wool 30°C	2.0	0:50	0.250	38.0	30	800	37.0
	RapidCare14'30°C	1.0	0:14	0.250	38.0	30	1000	65.0
9 kg 1400 r	Eco 40-60	9.0	3:48	0.760/0.750	68.0	35	1330/1550	52.0
	Eco 40-60	4.5	2:52	0.550	43.0	33	1330/1550	52.0
	Eco 40-60	2.5	2:52/2:45	0.230/0.240	35.0	25	1330/1550	56.0
	Cotton 20°C	9.0	1:58	0.220	80.0	20	1000	65.0
	Cotton 60°C	9.0	3:03	2.300	80.0	57	1400/1600	53.0
	Wool 30°C	2.0	0:50	0.250	40.0	30	800	37.0
	RapidCare14'30°C	1.0	0:14	0.250	40.0	30	1000	65.0
10 kg 1600 r	Eco 40-60	10.0	3:58	0.865	78.0	35	1550	52.0
	Eco 40-60	5.0	2:58	0.560	47.0	33	1550	52.0
	Eco 40-60	2.5	2:58	0.250	35.0	25	1550	56.0
	Cotton 20°C	10.0	1:58	0.220	85.0	20	1000	65.0
	Cotton 60°C	10.0	3:03	2.500	85.0	57	1600	53.0
	Wool 30°C	2.5	0:50	0.300	45.0	30	800	37.0
	RapidCare14'30°C	1.0	0:14	0.250	40.0	30	1000	65.0
10.5kg 1400r	Eco 40-60	10.5	3:58	1.035	98.0	35	1330	53.0
	Eco 40-60	5.5	2:58	0.700	55.0	33	1330	52.0
	Eco 40-60	2.5	2:58	0.270	40.0	25	1330	54.0
	Cotton 20°C	10.5	1:58	0.250	100.0	20	1000	65.0
	Cotton 60°C	10.5	3:03	2.800	100.0	57	1400	55.0
	Wool 30°C	3.5	0:50	0.350	50.0	30	800	37.0
	RapidCare14'30°C	1.0	0:14	0.280	40.0	30	1000	65.0
12 kg 1400r	Eco 40-60	12.0	3:58	1.035	98.0	35	1330	53.0
	Eco 40-60	6.0	2:58	0.700	55.0	33	1330	52.0
	Eco 40-60	3.0	2:58	0.270	40.0	25	1330	54.0
	Cotton 20°C	12.0	1:58	0.250	100.0	20	1000	65.0
	Cotton 60°C	12.0	3:03	2.800	100.0	57	1400	55.0
	Wool 30°C	3.5	0:50	0.350	50.0	30	800	37.0
	RapidCare14'30°C	1.0	0:14	0.280	40.0	30	1000	65.0

The values given for programmes other than the Eco 40-60 programme and the wash and dry cycle are indicative only.

8.1 Power supply

Connect the washing machine to a power supply (220V to 240V~/50Hz; Fig. 8-1). Please refer also to section INSTALLATION (see P28).

8.2 Water connection

- ▶ Before connecting check the cleanliness and clarity of the water inlet.
- ▶ Turn on the tap (Fig. 8-2).

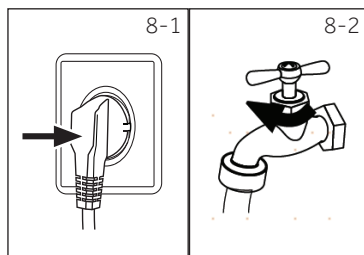

i Note: Tightness

Before use check for leakage in the joints between the tap and the inlet hose by turning on the tap.

8.3 Preparing laundry

- ▶ Sort out clothes according to fabric (cotton, synthetics, wool or silk) and to how dirty they are (Fig. 8-3). Pay attention to the care labelling of washing labels.
- ▶ Separate white clothes from coloured ones. Wash coloured textiles first by hand to check if they fade or run.
- ▶ Empty pockets (keys, coins, etc.) and remove harder decorative objects (e.g. brooches).
- ▶ Garments without hems, delicates and finely woven textile such as fine curtains are to be put into a wash bag to care for this delicate laundry (hand or dry cleaning would be better).
- ▶ Close zippers, velco fastener and hooks, make sure the buttons are sewn on tightly.
- ▶ Place sensitive items like laundry without firm hem, delicate underwear (Dessous) and small items such as socks, belts, bras, etc. in a wash bag.
- ▶ Unfold large pieces of fabric such as bed sheets, bedspreads etc.
- ▶ Turn jeans and printed, decorated or color-intensive textiles inside out; possibly wash separately.

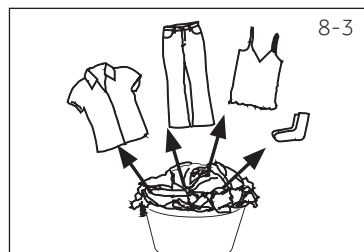

! CAUTION!

Non-textile, as well as small, loose or sharp-edged items may cause malfunctions and damage of clothes and appliance.

8.4 Care chart

Washing		
 Washable up to 95°C normal process	 Washable up to 60°C normal process	 Washable up to 60°C mild process
 Washable up to 40°C normal process	 Washable up to 40°C mild process	 Washable up to 40°C very mild process
 Washable up to 30°C normal process	 Washable up to 30°C mild process	 Washable up to 30°C very mild process
 Wash by hand max. 40°C	 Do not wash	
Bleaching		
 Any bleaching allowed	 Only oxygen/ non-chlorine	 Do not bleach
Drying		
 Tumble drying possible normal temperature	 Tumble drying possible lower temperature	 Do not tumble dry
 Line drying	 Flat drying	
Ironing		
 Iron at a maximum temperature up to 200 °C	 Iron at a medial temperature up to 150°C	 Iron at a low temperature up to 110 °C; without steam (steam ironing may cause irreversible damage)
 Do not iron		
Professional Textile Care		
 Dry cleaning in tetra-chloroethene	 Dry cleaning in hydrocarbons	 Do not dry clean
 Professional wet clean	 Do not professional wet clean	

8.5 Loading the appliance

- ▶ Put in the laundry piece by piece.
- ▶ Don't overload. Note the different maximum load according to programmes! Rule of thumb for maximum load: Keep six inches between load and drum top.
- ▶ Close the door carefully. Make sure that no pieces of laundry are pinched.













Note: Auto Weight

The display default time may vary depending on the load weight, involving the "COTTONS, ECO 40-60, 20°C, SYNTHETIC & COLOURED, ALLERGY CARE PRO, AUTO CARE, NIGHT & DAY" program.

8.6 Selecting detergent

- ▶ Washing efficiency and performance is determined by used detergent quality.
- ▶ Use only machine wash approved detergent.
- ▶ If needed use specific detergents, e.g. for synthetic and woolen fabric.
- ▶ See tips for countertop detergent stickers.
- ▶ Do not use dry cleaning agents such as trichloroethylene and similar products.

Choose the best detergent

Programme		Kind of detergent				
		Universal	Colour	Delicate	Special	Softener
	Auto Care	L/P	L/P	-	-	o
	All in One 49'	L	L	-	-	o
	Rapid Care 14' 30' 44'	L	L	-	-	-
	Allergy Care Pro	-	-	o	o	o
	Steam Care Pro	-	-	-	-	-
	Soft Care	-	-	o	o	o
	Fitness Care	-	-	o	o	o
	Rinse	-	-	-	-	o
	Cottons	L/P	L/P	-	-	o
	ECO 40-60	L/P	L/P	-	-	o
	Wool & Handwash	-	-	L/P	L/P	o
	20°C	L/P	L/P	-	-	o
	Synthetic & Coloured	-	O	-	-	o
	Drain & Spin	-	-	-	-	-
	Active Wash	L	L	-	-	-
	Night & Day	L/P	L/P	-	-	o
	Drum Clean	-	-	-	o	-

L = gel-/liquid detergent P = powder detergent O = optional - = no
If using liquid detergent, it is not recommended to activate the time delay.

We recommend by using:

- ▶ Laundry powder: 20°C to 90°C* (best use: 40-60°C)
- ▶ Color detergent: 20°C to 60°C (best use: 30-60°C)
- ▶ Wool/delicate detergent: 20°C to 30°C (= best use: 20°C to 30°C)

*Choose 90°C wash temperature only for special hygienic requirements.

*If you choose the water temperature 60°C or above, we would like to advise you to use less detergent.

* It is better to use less or free suds detergent powder.

* Suggested detergent type on remote control depends on the program chosen on APP.

8-4

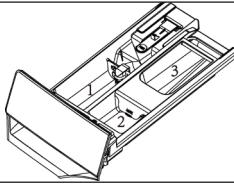

8.7 Adding detergent

1. Slide out the detergent drawer.
2. Put the required chemicals into corresponding compartments (Fig. 8-4)
3. Push back the drawer gently.

i Note: Detergent

- ▶ Remove detergent residues before next wash cycle from the detergent drawer.
- ▶ Do not overuse detergent or softener.
- ▶ Please follow the instruction on the detergent package.
- ▶ Always fill the detergent just before the beginning of the wash cycle.
- ▶ Concentrated liquid detergent should be diluted before adding.
- ▶ Do not use liquid detergent if "Delay" is selected.
- ▶ Carefully choose the programme settings according to the care symbols on all laundry labels and according to the programme table.

8-5

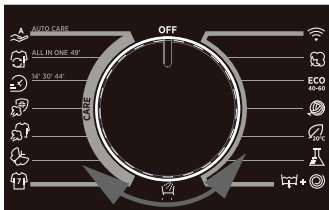

8.8 Switch on the appliance

Turn the knob (Fig.8-5) from "OFF" to any position to switch on the machine.

8.9 Select a programme

To get the best washing results, select a programme which fits the degree of soiling and sort of laundry type.

Turn the programme knob (Fig. 8-5) to select the right programme. The display will show the selected programme name.

i Note: Odor removal

Before first use we recommended to run programme "DRUM CLEAN " to remove possibly corruptive residues. Please don't put any detergent or special machine cleaner in washing agent compartment (2).

8-6



8.10 Add individual selections

Select required options and settings (Fig. 8-6); refer to CONTROL PANEL.

8.11 Start wash programme

Touch "Start/Pause" button (Fig. 8-7) to start. Appliance operates according to present settings. Changes are only possible by cancelling the programme.



8.12 Interrupt / cancel wash programme

To interrupt a running programme press gently "Start/Pause". The LED above the button is flashing. Press it again to resume operation.

To cancel a running programme and all its individual settings

1. Touch "Start/Pause" button to interrupt the running programme.
2. Turn the knob to the programme DRAIN & S PIN and select "NO SPIN" to drain the water.
3. After closing the programme to restart the appliance, select a new programme and start it.

8.13 After washing



Note: Door lock

- ▶ For safety reasons the door is locked partially during the washing cycle. It is only possible to open the door at the end of the programme or after the programme was cancelled correctly (see description above).
- ▶ In case of high water level, high water temperature and during spinning it is not possible to open the door; **Lock** is displayed.

1. At programme cycle end **END** is displayed.
2. The appliance switches off automatically.
3. Remove laundry as soon as possible to go easy on it and to prevent more wrinkling.
4. Turn off the water supply.
5. Unplug the power cord.
6. Open the door to prevent formation of moisture and odours. Let it open while not used.



Note: Standby mode / energy-saving mode

The switched on appliance will go into standby-mode if it will not be activated within 2 minutes before starting the programme or at the end of programme, except REMOTE CONTROL. The display switches off. This saves energy. To interrupt the standby mode turn the knob to any other programme except "OFF".

8.14 Activate or deactivate the buzzer

The acoustic signal can be deselected if necessary:

In the standby mode after power on, long press the button "OPTION" for more than 5S to turn off the sound. The interface will display "SOUND OFF". Press and hold this key again for more than 5S, and the interface will "SOUND ON".

9.1 General

This appliance is equipped with Wi-Fi technology that allows you to control it remotely via App.



WARNING!

Please observe the safety precautions in this user manual and make sure that these are complied with even when operating the appliance via the hOn APP while you are away from home. You must also follow the instructions in the hOn.

9.2 Requirements

1. One wireless router (802.11b/g/n protocol) which supports only the frequency band of 2.4 GHz. Length of Router SSID is 1-31 characters(including 1 and 31), and password is 8-64 characters. Minimum length of password must be 8 characters. Router encryption methods include open, WPA-PSK and WPA2-PSK.
2. The App is available for devices running Android, Huawei or iOS, both for tablets and for smartphones.
3. The appliance shall be installed in a position where it can receive a strong Wi-Fi signal. Once the appliance has been correctly associated with the APP, if it's not properly connected to the wireless router, no Wi-Fi icon appears on the display

9.3 Download and installation of hOn APP:

Download the hOn App on your device by framing the following QR code:



Download the
hOn App



or by the link: go.haier-europe.com/download-app

Frequency rate (OFR)	2400 MHz - 2483,5 MHz
Max. power (ERP)	20dBm
Wireless standard	IEEE802.11b/g/n & BLE V4.2



Note: Registration

Registration is required when first time to use or the formal account has been deleted/ closed. For further use, you need to enter user name and password after you log in.

9.4 Appliance pairing (on app)

1. The App is available for devices running both Android and iOS, both for tablets and for smartphones.
2. Get all the details of the Wi-Fi functions by browsing the App in DEMO mode.
3. The frequency of the home Wi-Fi network has to be set on the 2.4 GHZ band. You cannot configure the machine if your home network is set to the 5 GHZ band.
4. Open the App, create the user profile (or log-in if it is already created previously) and pairing the appliance following the instructions on the device display.



Note: Wi-Fi Network

It is not possible to connect the appliance to a public Wi-Fi network. It may cause malfunction.



Note: Use same Wi-Fi

Connect with your smartphone to the network you want to connect the product to.

9.5 To enable remote control

1. Check that the router is switched on and connected to the Internet.
2. Load the laundry, close the door, add the detergent if it's necessary.
3. Turn the programme selector to the REMOTE CONTROL (Wi-Fi) position.  The door will lock and the controls on the control panel will be disabled.
4. Start the cycle using the App. When the cycle has been completed, turn off the machine by turning the programme selector to the OFF position to unlock the door.



Note: Remote control expiration

Once the remote control is activated, if the end user doesn't start any cycle from App in 10 minutes, the appliance will go to Networked Delay Start Mode, and keeps remote control up to 24 hours, then shut off.

9.6 To disable remote control

1. To exit REMOTE CONTROL mode while a cycle is underway, turn the programme selector to any position other than REMOTE CONTROL (Wi-Fi), without going through the OFF. The control panel on the appliance will be operative once again, and if the cycle is paused, you will be able to open the door once the DOOR LOCKED indicator light switches off.
2. For safety reasons, in some wash cycle phases, the door can be opened only if the level of the water is below its lower edge and if the temperature is below its lower edge. If these conditions are met, wait for the DOOR LOCKED light to switch off before opening the door.
3. With the door closed, turn the knob to the REMOTE CONTROL (Wi-Fi) position to control the appliance using the App once again. If there is a cycle underway, it will continue.

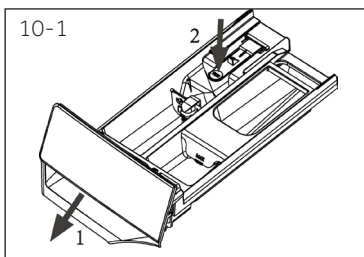

10.1 Cleaning the detergent drawer

Take always care there are no detergent residues. Clean the drawer regularly (Fig. 10-1):

1. Pull out the drawer until it stops.
2. Press the release button and remove the drawer.
3. Flush the drawer with water until it is clean and insert the drawer back in the appliance.



10.2 Cleaning the machine

- ▶ Unplug the machine during cleaning and maintenance.
- ▶ Use a soft cloth with soap liquid to clean the machine case (Fig. 10-2) and rubber components.
- ▶ Do not use organic chemicals or corrosive solvents.

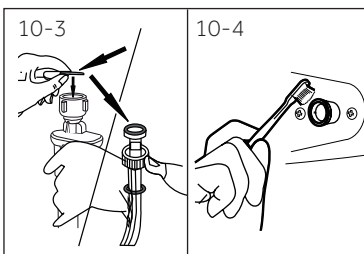

10.3 Water inlet valve and inlet valve filter

To prevent blockage of water supply by solid substances like lime clean regularly the inlet valve filter.

- ▶ Unplug the power cord and turn off the water supply.
- ▶ Unscrew the water inlet hose at the back (Fig. 10-3) of the appliance as well as on the tap.
- ▶ Flush the filters with water and a brush (Fig. 10-4).
- ▶ Insert the filter and install the inlet hose.

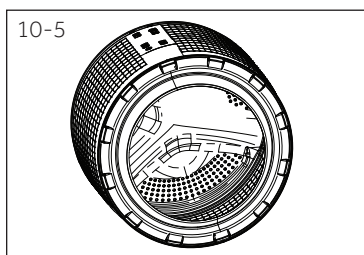

10.4 Cleaning the drum

- ▶ Remove accidentally washed items, especially metal parts such as pins, coins, etc. from the drum (Fig. 10-5) because they cause rust stains and damage.
- ▶ Use a non-chloride cleaner for removing rust stains. Observe the warning hints of the cleaning agent manufacturer.
- ▶ Do not use any hard objects or steel wool for cleaning.

10.5 Long periods of disuse

If the appliance is left idle for a longer period:

1. Pull out the electrical plug (Fig. 10-6).
2. Turn off water supply (Fig. 10-7).
3. Open the door to prevent formation of moisture and odours. Let door open while not used.

Before next usage check carefully power cord, water inlet and drain hose. Make sure everything is properly installed and without leakage.

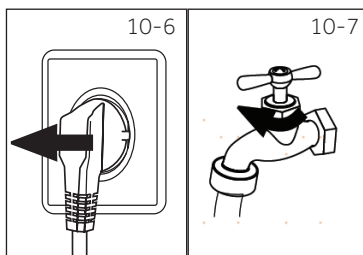

10.6 Pump filter

Clean the filter once a month and check the pump filter for instance if the appliance:

- ▶ Doesn't drain the water.
- ▶ Doesn't spin.
- ▶ Cause unusual noise while running.

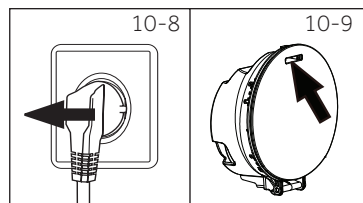

WARNING!

Scalding Risk! Water in the pump filter can be very hot! Before any action please ensure water has cooled down.

1. Turn off and unplug the machine (Fig. 10-8).
2. Open service flap. You can either use a coin or a screwdriver (Fig. 10-9).
3. Provide a flat container to catch leach water (Fig. 10-10). There could be bigger amounts!
4. Pull the drainhose out and hold its end above the container (Fig. 10-10).
5. Take the sealing plug out of the drainhose (Fig. 10-10).
6. After complete drainage close drainhose (Fig. 10-11). and push it back into the machine.
7. Unscrew and remove counter clockwise the pump filter (Fig. 10-12).
8. Remove contaminants and dirt (Fig. 10-13).

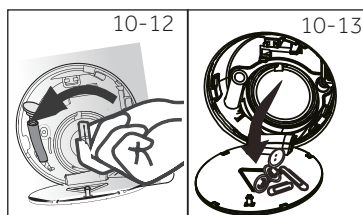
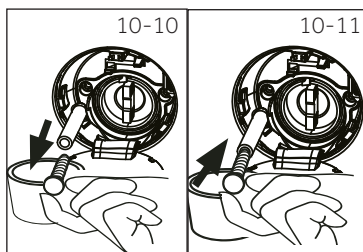

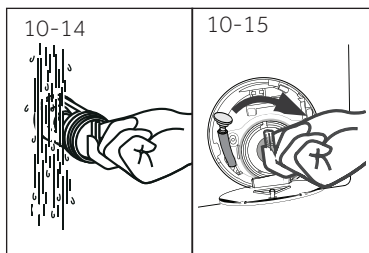

9. Clean carefully pump filter, e.g. using running water (Fig. 10-14).
10. Refix it thoroughly (Fig. 10-15).
11. Close service flap.



CAUTION!

- ▶ Pump filter sealing has to be clean and unhurt. If the lid is not full tightened, water can escape.
- ▶ The filter must be in place, or it may lead to leakage.

Many occurring problems could be solved by yourself without specific expertise. In case of a problem please check all shown possibilities and follow below instructions before you contact an after sales service. See CUSTOMER SERVICE.



WARNING!

- ▶ Before maintenance, deactivate the appliance and disconnect the mains plug from the mains socket.
- ▶ Electrical equipment should be serviced only by qualified electrical experts, because improper repairs can cause considerable consequential damages..
- ▶ A damaged power cable should only be replaced by the manufacturer, its service agent or similarly qualified persons in order to avoid a hazard.

11.1 Information codes

Following codes are displayed only for information referring to the washing cycle. No measures must be performed.

Code	Message
1:25	The remaining wash cycle time will be 1 hour and 25 minutes
6:30	The remaining wash cycle time including chosen end-time delay will be 6 hours and 30 minutes
CHILD LOCK ON	Function child lock is activated .
CHILD LOCK OFF	Function child lock is not activated .
END	The washing cycle is finished. The appliance shuts off automatically
LOCK	Door is closed because of high water level, high water temperature or spinning cycle.
SOUND OFF	The buzzer is activated
SOUND ON	The buzzer is deactivated

11.2 Troubleshooting with display code

Problem	Cause	Solution
CLR FLTR	<ul style="list-style-type: none"> • Drainage error, water is not fully drained within 6 minutes. 	<ul style="list-style-type: none"> • Clean pump filter. • Check drain hose installation.
E2	<ul style="list-style-type: none"> • Lock error 	<ul style="list-style-type: none"> • Shut the door properly.
E4	<ul style="list-style-type: none"> • Water level not reached after 12 minutes. • Drain hose is self-syphoning. 	<ul style="list-style-type: none"> • Make sure that tap is fully opened and water pressure is normal. • Check drain hose installation.
E8	<ul style="list-style-type: none"> • Water protective level error. 	<ul style="list-style-type: none"> • Contact the After sales service.

Problem	Cause	Solution
F3	<ul style="list-style-type: none"> Temperature sensor error. 	<ul style="list-style-type: none"> Contact the After sales service.
F4	<ul style="list-style-type: none"> Heating error. 	<ul style="list-style-type: none"> Contact the After sales service.
F7	<ul style="list-style-type: none"> Motor error 	<ul style="list-style-type: none"> Contact the After sales service
FA	<ul style="list-style-type: none"> Water level sensor error. 	<ul style="list-style-type: none"> Contact the After sales service.
FC0, FC1 OR FC2	<ul style="list-style-type: none"> Abnormal communication error. 	<ul style="list-style-type: none"> Contact the After sales service.
FH	<ul style="list-style-type: none"> The iot module fails to be configured. 	<ul style="list-style-type: none"> Contact the After sales service to replace the iot module.
E5	<ul style="list-style-type: none"> Drainage error. 	<ul style="list-style-type: none"> Water is not fully drained in set time.

11.3 Troubleshooting without display code

Problem	Cause	Solution
Appliance fails to operate.	<ul style="list-style-type: none"> Programme is not yet started. Door is not properly closed. Machine has not been switched on. Power failure. Child lock is activated. 	<ul style="list-style-type: none"> Check programme and start it. Close the door properly. Switch the machine on. Check power supply. Deactivate child lock.
Appliance will not be filled with water.	<ul style="list-style-type: none"> No water. Inlet hose is kinked. Inlet hose filter is blocked. Water pressure is less than 0.03 MPa. Door is not properly closed. Water supply failure. 	<ul style="list-style-type: none"> Check water tap. Check inlet hose. Unblock inlet hose filter. Check water pressure. Close the door properly. Ensure the water supply.
Appliance is draining while being filled.	<ul style="list-style-type: none"> Height of drain hose is below 80 cm. Drain hose end could reach into water. 	<ul style="list-style-type: none"> Make sure that drain hose is properly installed. Make sure the drain hose is not in water.
Drainage failure.	<ul style="list-style-type: none"> Drain hose is blocked. Pump filter is blocked. Drain hose end is higher than 100 cm above floor level. 	<ul style="list-style-type: none"> Unblock drain hose. Clean pump filter. Make sure that drain hose is properly installed.
Strong vibration while spinning	<ul style="list-style-type: none"> Not all transportation bolts have been removed. Appliance has no solid position. Machine load is not correct. 	<ul style="list-style-type: none"> Remove all transportation bolts. Ensure solid ground and a levelled position Check load weight and balance.
Operation stops before completing wash cycle	<ul style="list-style-type: none"> Appliance displays error code Problem due to load pattern. Programme performs soaking cycle 	<ul style="list-style-type: none"> Consider display codes. Reduce or adjust load. Cancel programme and restart.
Operation stops for a period of time.	<ul style="list-style-type: none"> Appliance displays error code. Problem due to load pattern. Programme performs soaking cycle. 	<ul style="list-style-type: none"> Consider display codes. Reduce or adjust load. Cancel programme and restart.

Problem	Cause	Solution
Excessive foam floats drum and/or detergent drawer.	<ul style="list-style-type: none"> Detergent is not appropriate. Excessive use of detergent. 	<ul style="list-style-type: none"> Check detergent recommendations. Reduce amount of detergent.
Automatic adjustment of washing time.	<ul style="list-style-type: none"> Washing programme duration will be adjusted. 	<ul style="list-style-type: none"> This is normal and doesn't affect functionality.
Spinning fails.	<ul style="list-style-type: none"> Unbalance of laundry. 	<ul style="list-style-type: none"> Check machine load and laundry and run a spinning programme again.
Unsatisfactory washing result.	<ul style="list-style-type: none"> Degree of pollution does not agree with selected programme. Detergent quantity was not sufficient. Maximum load has been exceeded. Laundry was unevenly distributed in the drum. 	<ul style="list-style-type: none"> Select an other programme. Choose the detergent acc. to the degree of pollution and acc. to manufacturer specifications. Reduce loading. Loose the laundry.
Washing powder residues are on the laundry.	<ul style="list-style-type: none"> Insoluble particles of detergent can remain as white spots on the laundry. 	<ul style="list-style-type: none"> Perform extra rinse. Try to brush the points from the dry laundry. Choose an other detergent.
Laundry has grey patches.	<ul style="list-style-type: none"> Caused by fats such as oils, creams or ointments. 	<ul style="list-style-type: none"> Pretreat the laundry with a special cleaner.

i Note: Foam formation

If too much foam is inspected during spin cycle, motor stops and drain pump will be activated for 90 seconds. If that elimination of foam fails up to 3 times, programme ends without spinning.

Should the error messages reappear even after the taken measures, switch off the appliance, disconnect the power supply and contact the customer service.

11.4 In case of power failure

The current programme and its setting will be saved. When power supply is restored operation will be resumed.

If a power failure cuts an operating wash programme door opening is mechanically blocked. To get out any laundry water level should not be seen in the glassy porthole of the door - Danger of burns! Water level has to be lowered as described in "Pump filter". Not till then pull lever (A) beneath service flap (Fig. 11-1) until door is unlocked by a gentle click. Afterwards refix all parts.

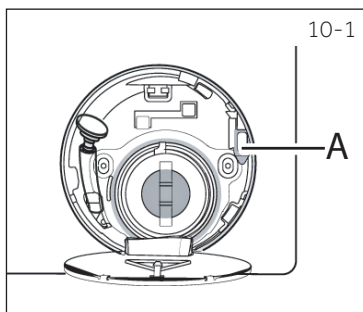

i Note: Unlock the door

When the washing machine in a safe state (under the water level below the window along a certain distance, barrel temperature below 55 °C, the inner barrel did not turn), may unlock the doors of the machine operation

11.1 Additional technical data

	H7W 448*	H7W 449*	H7W 610*	H7W 69*	H7W4105*	H7W 412*
Voltage in V	220-240 V~/50Hz					
Current in A	10					
Max. power in W	1900					
Water pressure in MPa	0,03-≤P≤1					
Netto weight in kg	55	58	64	64	69	69

11.2 Product dimensions

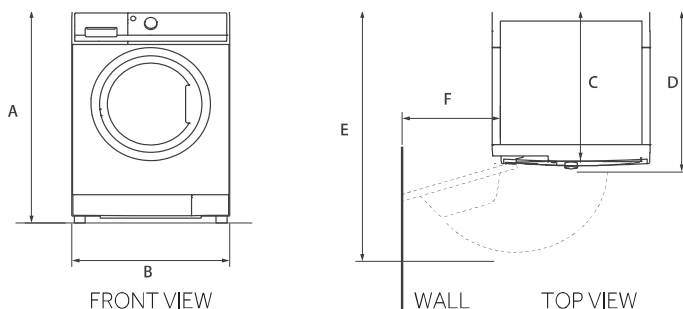

PRODUCT DIMENSIONS	H7W 448*	H7W 449*	H7W 610*	H7W 69*	H7W4105*	H7W 412*
A Overall height of product mm	850					
B Overall width of product mm	595					
C Overall depth of product (To main control board size) mm	414	447	503		605	
D Depth of door open mm	480	510	565		665	
E Minimum door clearance to adjacent wall mm	955	995	1050		1150	
F Overall depth of product (Including the thickness of the door) mm	205					



Hinweis: Exact height

The exact height of your washer is dependent on how far the feet are extended from the base of the machine. The space where you install your washer needs to be at least 40mm wider and 20mm deeper than its dimensions.

11.3 Standards and Directives **CE**

This product meets the requirements of all applicable EC directives with the corresponding harmonised standards, which provide for CE marking.

We recommend our Hoover Customer Service and the use of original spare parts.

If you have a problem with your appliance, please first check section TROUBLESHOOTING.

If you cannot find a solution there, please contact

- ▶ your local dealer or
- ▶ the Assistance Area on the Hoover website where you can find information on Warranties, Accessories and Spare Parts and Contact numbers.

To contact our Service, ensure that you have the following data available.

Each product is identified by a unique code, also called the "serial number", printed on a sticker. This can be found inside the door opening.

Model _____ Serial No. _____

Also check the Warranty Card supplied with the product in case of warranty.

It is always recommended to use original spare parts, that are available at our Authorised Customer Service Centres.

Warranty

The product is guaranteed under the terms and conditions stated on the certificate included with the product. The certificate has to be stored so as to be shown to the Authorized Customer Service Centre in case of need. You can also check the warranty conditions on our web site. To obtain assistance, please fill in the form on-line or contact us at the number indicated on the support page of our web site.

The standard manufacturer warranty covers faults caused by electrical or mechanical faults in the product due to an act or omission of the manufacturer. If a fault is found to be caused by factors outside the product supplied, miss-use or as a result of the instructions on use not being followed, a charge may be applied.

The manufacturer declines all responsibility for any printing errors in the booklet included with this product. Moreover, it also reserves the right to make any changes deemed useful to its products without changing their essential characteristics.

