

# Instruction Book

# NEXTRA

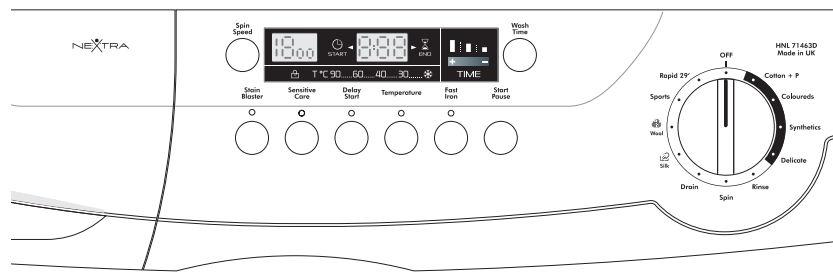

# Contents

<b>Introduction</b> .....	3
Delivery information .....	3
Do's and Don'ts .....	3
<b>Unpacking the Product</b> .....	4
<b>Installation</b> .....	7
Choose a location .....	7
Electricity supply .....	7
Water supply .....	7
Connecting to the cold water supply .....	8
Connection of the machine to the drain .....	9
Moving the machine into position .....	10
Adjusting the feet .....	10
<b>Testing the installation</b> .....	11
<b>Washing advice</b> .....	12
Loading your washing machine .....	12
Sorting the laundry .....	13
<b>The Dispenser</b> .....	14
Detergent dosage .....	14
Dispensing instructions .....	15
<b>The Control Panel</b> .....	16
<b>Wash Options</b> .....	18
Automatic Features .....	20
<b>Programme Selector</b> .....	20
<b>Programme Guide</b> .....	22
<b>A Typical Wash</b> .....	23
Selecting the wash programme .....	24
Starting the wash cycle .....	24
<b>Cleaning and Routine Maintenance</b> .....	25
<b>Troubleshooting</b> .....	27
Power Failure .....	30
<b>Customer Service</b> .....	31
<b>Your Guarantee</b> .....	32
Hoovercare .....	32

# Introduction

Please read and follow these instructions carefully and operate the machine accordingly. This booklet provides important guidelines for safe use, installation, maintenance and some useful advice for best results when using your machine.

Keep all documentation in a safe place for future reference or for any future owners.

## Delivery information

Please check that the following items are delivered with the appliance:

- Instruction manual
- Guarantee card
- Blanking plug
- Inlet hose & bracket
- Base panel & x2 push clips
- Energy Label

## Do's

- All packaging materials used are environmentally-friendly and recyclable. Please help dispose of the packaging via environmentally-friendly means. Your local council will be able to give you details of current means of disposal.
- To ensure safety when disposing of an old washing machine disconnect the mains plug from the socket, cut the mains power cable and destroy this together with the plug. To prevent children shutting themselves in the machine break the door hinges or the door lock.
- This machine is solely for domestic use, i.e. to wash, rinse and spin dry household textiles and garments.

## Don'ts

- Do not touch the appliance when hands or feet are damp or wet.
- Do not lean on the door when loading the machine or use the door to lift or move the machine.
- Do not use adapters, multiple connectors and or extensions.
- Do not allow children to play with the machine or its controls.
- Do not try to open the door when water is visible in the drum or the door locked indicator is ON.

**Check that no damage has occurred to the machine during transit. If it has, call for service by GIAS.**

**Call  
08705 400 600**

### PLEASE NOTE

**This machine only requires a cold water supply**

**If the appliance is not running properly or breaks down, switch it off, disconnect the plug from the socket, turn off the water supply and do not tamper with the appliance. Consult GIAS Service for possible repair.**

**Call  
08705 400 600**

**Failure to comply with the above can compromise the safety of the appliance. You may be charged for a service call if a problem with your machine is caused by misuse.**

# Unpacking the product



Remove the machine from its packaging close to the final location of the machine.

1. Cut carefully around the base of the packaging.

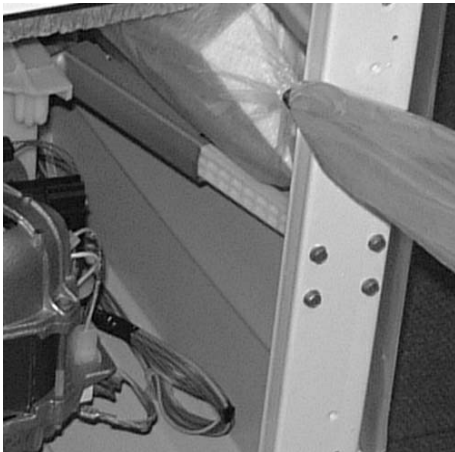

2. Lay the machine on its back and remove the base and the two polystyrene spacers on each side of the machine. We recommend that a second person assist in the lifting and manoeuvring of the machine.

**Dispose of the packaging safely. Make sure it is out of the reach of children, it is a potential source of danger.**



3. Return the machine to the upright position, remove the remainder of the packaging and the central screw in the transit bar.

4. Remove the four retaining screws in the transit bar and pull out the transit bracket.

**We recommend you keep the transit bracket and screws to protect the machine for future transit.**

**The manufacturers will not be responsible for any damage to the machine caused by not following the instructions relating to releasing the transit protection. The user is responsible for all installation costs.**

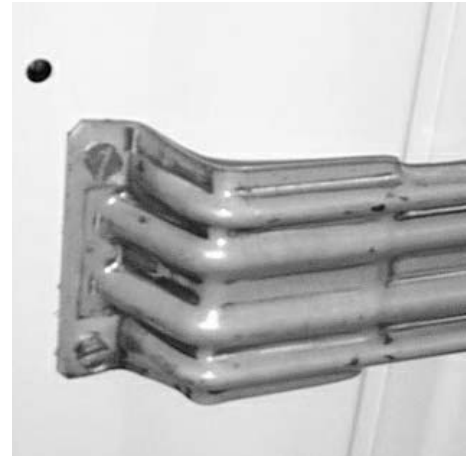

5. Take the base panel provided and fit the two self adhesive strips by removing the backing paper on one side and locating the strips on each side of the base panel.

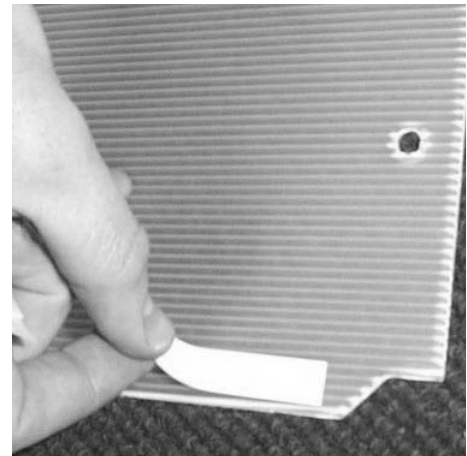

6. Tilt the machine forward and locate the base panel under the front of the machine. Remove the remaining backing paper from the self-adhesive strips and offer up the base panel to the bottom of the cabinet.



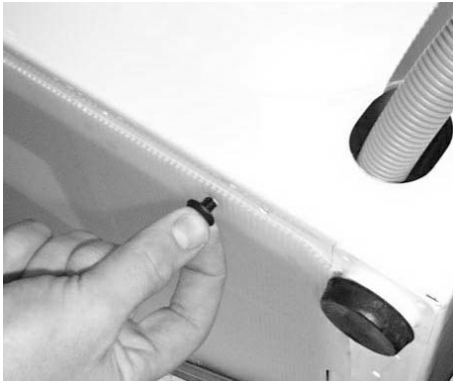

7. Take the two plastic fixing clips and fix the base panel to the base of the machine. Bring the machine back to the upright position.



8. Cover the central hole in the rear of the machine with the cap enclosed in the instruction bag.



## ***European directive 2002/96/EC***

This appliance is marked according to the European directive 2002/96/EC on Waste Electrical and Electronic Equipment (WEEE).

By ensuring this product is disposed of correctly, you will help prevent potential negative consequences for the environment and human health, which could otherwise be caused by inappropriate waste handling of this product.

The symbol on the product indicates that this product may not be treated as household waste. Instead it shall be handed over to the applicable collection point for the recycling of electrical and electronic equipment.

Disposal must be carried out in accordance with local environmental regulations for waste disposal.

For more detailed information about treatment, recovery and recycling of this product, please contact your local city office, your household waste disposal service or the shop where you purchased the product.

# Installation

## Choose a location

- After the machine has been installed, ensure that the mains plug and water supply valves are easily accessible.
- Make sure there is enough space for the machine. Select a space at least 600mm wide and 850mm high. Also leave enough space to open the door fully so you can load and unload it easily.
- Keep the area underneath and around the machine free of combustible materials such as lint, paper, rags, chemicals etc.

## Electricity supply

Washing machines are supplied to operate at a voltage of 240V, 50 Hz single phase. Check that the supply circuit is rated to at least 13A.

The plug is already equipped with a 13A fuse which is BS 1362 ASTA approved. Any replacement must be the same rating and specification. **If the fuse cover is lost, do not use the plug until it is replaced.**

**Electricity can be extremely dangerous.**

**This washing machine must be earthed.**

**The socket outlet and the plug on the appliance must be of the same type.**

**Do not use multiple adapters and/or extension leads.**

The wires in the mains lead are coloured in accordance with the following codes:

Blue	NEUTRAL
Brown	LIVE
Green and Yellow	EARTH

CE Appliance complies with European Directive 89/336/EEC, 73/23/EEC and subsequent amendments.

## Water supply

- The cold water pressure should be between 0.5 and 8 bar (0.05-0.8 Mpa).
- **Do not connect the machine to a single outlet instantaneous water heater.**
- The water supply tap should be accessible when the machine is installed.
- Before connecting the fill hose, check that the water is running from the water supply tap to be used.

**Do not plug the machine in and switch it on at the mains until the installation is completed.**

**You may be charged for a service call if a problem with your machine is caused by incorrect installation.**

**If the mains cord on this appliance is damaged, it must be replaced by a special cord which is ONLY obtainable from the GIAS spares service. It must be installed by a competent person.**

**Call GIAS  
01204 556111**

***This Appliance  
must be  
connected to a  
COLD WATER  
supply only.***

## ***Connecting to the cold water supply***

Only one hose is required to install this machine to a cold water supply.

Cold fill is an energy efficient system. Only the water required to wash the laundry is heated. There is no loss of heat in the pipeline from the hot water tank or the boiler.

If your previous machine installation was hot and cold fill ensure that the hot tap is firmly closed to prevent leakage.

This machine has an inlet hose with a 19mm (3/4") threaded ferrule fitted to the end, to attach between the threaded connector on the appliance and the water supply.

Only use the new hose supplied to connect the machine and ensure that the sealing washers are in place inside the hose connectors.

**Do not re-use old hoses which are attached to existing installations.**

**Do not over-tighten the connections. Hand tight is sufficient.**

**Do not trap or kink the hose.**

1. Connect the elbow end of the hose provided to the threaded inlet on the back of the machine.

**Grey pipe to the white threaded inlet on the machine.**

2. Hand tighten the connector.



3. Connect the straight ends of the pipes to the water supply; **ensure that there are no kinks.**
4. **Turn on the water supply and check for leaks.** If there is a leak, turn off the water supply, disconnect the hose and check the sealing washers are in place. Refit the hose and turn on the water supply.



## Connection of the machine to the drain

This machine must be connected in accordance with the water supply regulations. Water byelaws prohibit connection to a surface water drain.

Decide which plumbing option suits you best then follow the instructions below.

**All machines are tested with water prior to leaving the factory so a small amount of water may remain in the drum and drain hose. Flooding could occur if any part of the installation is not completed correctly.**

### Option 1

#### Waste pipe connection (waste trap)

Fit the hooked end support to the outlet pipe. Position at least 800mm off the floor.

After removing the blanking plug or cutting the membrane from the waste system securely fix the outlet pipe to the drainage system, using a hose clip.

Secure the hooked end support up to at least 800mm to avoid water being drawn back into the machine.

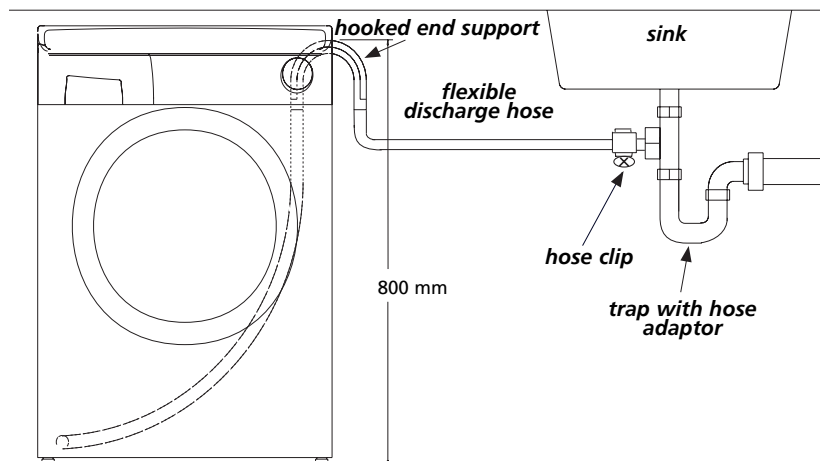

### Option 2

#### Into a standpipe

Ensure that the standpipe is not located near an electrical socket.

Fit the hooked end support to the outlet pipe. Install the hose into the standpipe ensuring that the pipe is at least 500mm from the floor.

Insert the outlet pipe approximately 100mm into the standpipe.

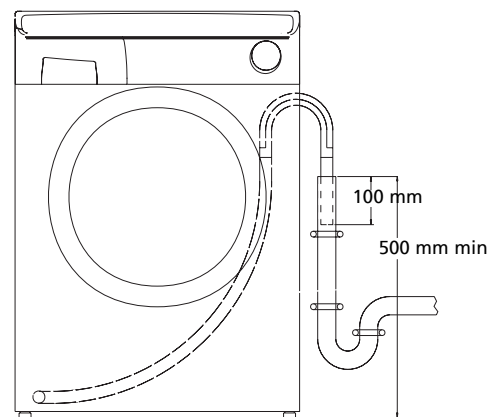

**Do not drag or lift the machine by its door.**

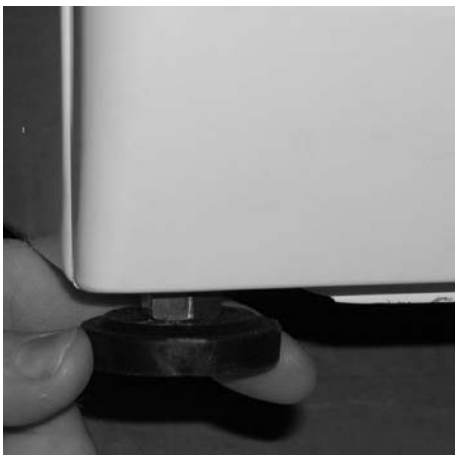

## ***Moving the machine into position***

Your machine is heavy so care must be taken when moving it. We recommend that two people move the machine to avoid strain and possible injury.

- Take care not to damage flooring when moving the machine.
- When moving the machine to its final position take care not to kink or damage the hose at the back of the machine.

## ***Adjusting the feet***

Once the machine is in place the feet should be adjusted to ensure that the machine is level. If the machine is not level it may become noisy or move.

Adjust the feet on the front corners of the machine until the machine is firm and level.

When the machine is firm and level, tighten the locking nuts on the two feet.

# ***Testing the installation***

Refer to 'Selecting the wash programme' for details of how to select programmes.

1. Turn on the water supply and check for leaks from the fill hose.
2. Switch on the electricity supply.
3. Select the Spin programme and then press the Start Pause button to start the machine. Allow the programme to continue for one minute and then cancel the programme by returning the selector to the OFF position. This will remove any water remaining in the machine from factory testing.
4. To check for cold water filling to the machine:  
Select the Rinse programme and press the Start Pause button to start the machine.  
  
Allow the tumble action to continue until the water has pumped out. Check that the drain outlet is not leaking or overflowing.
5. Switch off the machine at the end of the cycle by turning the programme knob to the OFF position.
6. Select the Spin programme and press the Start Pause button to start the machine. If the machine takes longer than one minute to empty check the drain hose for kinks.

***Installation testing is now complete.***

Now you have successfully installed the machine we advise that you run the machine to ensure the drum is thoroughly clean after testing and storage. Select Colourfast 60°C programme and run the machine for a complete cycle using only wash detergent and water.

***This programme will take approximately 2 hours to complete.***

# *Washing advice*

The following tips are designed to assist in getting the best results from your machine whilst using it in the most environmentally-friendly and economical way. It is also important to understand the items to avoid in your laundry, to ensure the continued safe and reliable operation of your machine.

## *Loading your washing machine*

To make further reductions of energy, water and detergent consumption, we recommend that you put a full load into your machine. Energy savings of up to 50% can be achieved by washing one full load compared to two half loads.

**Do not overload the machine as this will reduce the quality of the wash and may cause damage to the machine and your laundry.**

### *When is prewashing really needed?*

Only with particularly dirty loads! Energy savings of 5 to 15% are made by not selecting the prewash option for less dirty laundry. Pre-treat awkward stains with a washable stain remover.

### *Which wash temperature should you choose?*

Using stain removers before machine washing reduces the need to wash at temperatures over 60°C.

Using a 40°C wash temperature can make energy savings of up to 50%.

### *Heavily soiled laundry*

To ensure the best performance when washing a particularly dirty load, we recommend that you reduce the amount of items to be put into the machine. Allowing more space in the drum the items can circulate more freely and will wash better.

## ***Sorting the laundry***

### ***Items to avoid***

We recommend that you **do not** wash underwired bras in the machine. Should the wires become detached they could cause damage to your clothes and the machine. If the washcare label states that the bra is machine washable then we advise placing it in a wash bag.

### ***Recommendations***

**Always follow the wash care labelling on the garments.**

**Fasten zips, tie strings and close press studs to prevent tangling. Ensure that pockets are emptied of loose change and other small items.**

**Check that there are no metal objects in the laundry as these may damage the laundry and the machine.**

**Place small items in a wash bag.**

**Do not use the machine to wash items that do not have a wash label.**

**Do not wash items previously treated with solvents.**

# The Dispenser

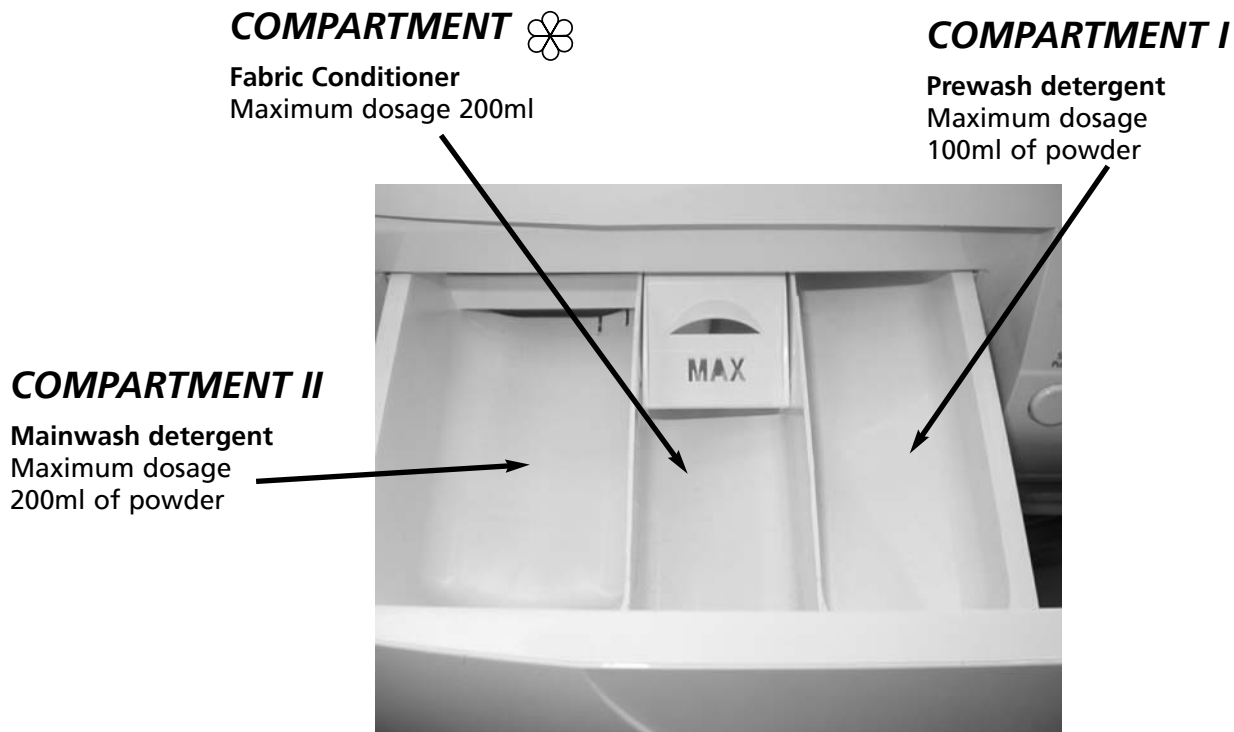

**DO NOT exceed  
the maximum  
detergent dosage**

## Detergent dosage

Only use detergents which are suitable for use in a washing machine. You will obtain the best results from your wash with the minimum use of chemical products, and the best care for your laundry if you take into consideration the degree of soiling as well as the type of detergent to choose.

The amount of detergent to use depends on:

- **Water hardness.**  
Depending on the hardness of the water and the type of detergent used, it is possible to reduce the amount of detergent.  
**The softer the water supply, the less detergent is required.**
- **The degree of soiling.**  
It is possible to reduce the amount of detergent used depending on the degree of soiling.  
**Use less detergent for less soiled items.**
- **Amount of laundry.**  
It is possible to reduce the amount of detergent when washing only a small amount of laundry.  
**For smaller loads use less detergent.**

The dosages shown on the packaging of detergents for washing delicates often already refer to a reduced wash size.  
**Always follow the dosage instructions on the detergent packaging.**

## ***Dispensing instructions***

The detergent drawer is split into 3 compartments:

- the lefthand compartment, labelled "II", is for detergent utilised during the main wash.
- the centre compartment, labelled  is for special additives such as fabric softeners, fragrances, starch, brighteners etc.
- the righthand compartment, labelled "I", is for detergent utilised during Prewash.

### ***Dispensing in the drum***

Liquid detergents and some tablets are dispensed via the machine drum using the recommended dispensing device which is placed upright on top of the washload towards the back of the drum. Some tablets are designed to be placed in the dispenser drawer, check the detergent pack for details.

**Do not put any items into the drawer other than detergents that are designed to be dispensed from the drawer as they may cause blockage or damage.**

# The Control Panel

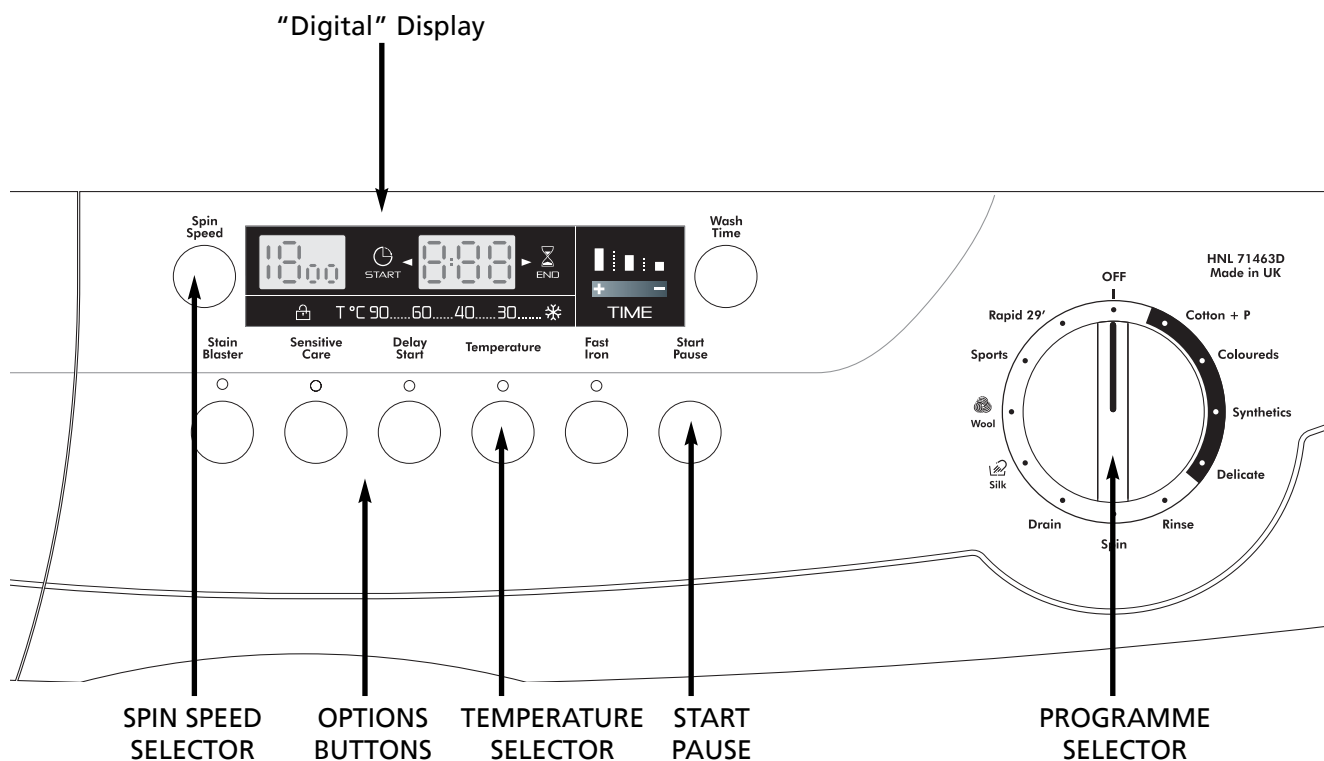

**The programme selector must be returned to the OFF position to reset the controls between each wash cycle.**

**To start another wash cycle the programme selector must be returned to OFF once again before the next programme can be selected and started.**

## Turning the machine On

Turn the machine ON by selecting a programme using the programme selector. This status will be indicated by the END indicator light flashing, this light will continue to flash until the machine has started or the machine is returned to the OFF position.

## Start Pause

### START

After selecting the programme and the required options press the Start Pause button once to start the wash cycle. The END light will stop flashing and START light will illuminate and there will be a short time delay to the start of the programme while the machine sets the wash parameters for the selected programme and options. The door locked indicator light (  ) will also illuminate a few seconds after pressing the Start Pause button.

### PAUSE

The programme may be paused at any time during the wash cycle by holding down the Start Pause button for about two seconds. The door locked indicator light will remain illuminated for approximately 2 minutes. The door can be



opened when this indicator goes out. To restart the programme, press the Start Pause button once again.

### ***Canceling and changing the programme***

To cancel the programme the programme selector should be rotated to the OFF position.

Select a new programme and start as detailed above.

### ***Door Locked indicator***

The door locked indicator light is illuminated when the door is fully closed and the machine is ON.

When Start Pause is pressed on the machine with the door closed the indicator will flash momentarily and then illuminate. If the door is not closed the indicator will continue to flash.

A special safety device prevents the door from being opened immediately after the end of the cycle. Wait for 2 minutes after the wash cycle has finished and the door locked light has gone out before opening the door. As a safety measure, check that there is no water evident in the drum. At the end of the cycle turn the programme selector to OFF.

If the programme is paused, the door locked indicator will go out after 2 minutes and the door can be opened. Check there is no water evident in the drum before opening the door.

### ***"Digital" Display***

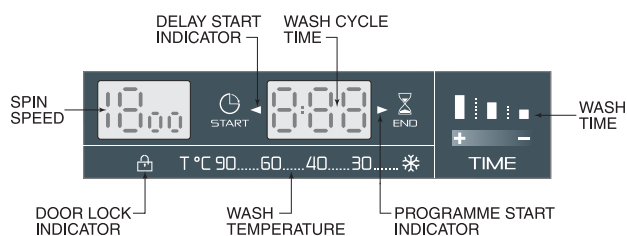

Information on the status of the wash programme is constantly provided by the display.

### ***Wash Temperature***

When a programme is selected the relevant indicator will light up to show the maximum possible wash temperature. Selecting a lower temperature using the **Temperature** button will be indicated on the display. Example: Coloureds programme will default to 60°C. With this control the temperature can be reduced to 40°C to give a non-fast coloureds wash.

Note: The temperature must be adjusted before selecting the **Wash Time**.

### ***Door Locked Indicator***

Once the Start Pause button has been pressed the light flashes and then remains on until the end of the wash cycle. 2 minutes after the end of the wash the light goes off to show that the door can be opened.



## ***Spin Speed***

When a programme is selected the maximum spin speed allowed for that programme appears on the display. Pressing the Spin Speed button will reduce the speed by 100 rpm each time the button is pressed. The minimum speed is 400 rpm, or continuing to press the button will eliminate the final spin completely.

## ***Delay Start***

This indicator flashes when the delay start has been set.

## ***Wash Cycle Time***

When a programme is selected the display automatically shows the wash cycle time, which can vary depending on the options selected. Once the programme has started you will be kept informed constantly of the time remaining to the end of the wash.

## ***Programme Start light***

This indicator will light up when the Start button has been pressed.

## ***Wash Time***

When the programme is selected the relevant indicator will light up to show the minimum possible wash time. Selecting the **Wash Time** using the button will cause the corresponding indicator to light up.

Note: the wash time can vary automatically depending on the temperature selected.

# ***Wash Options***

**The following options should be selected BEFORE pressing the Start Pause button.  
The light on each option button will come on if that option has been selected.**

## ***Stain Blaster***

By pressing this button, which can only be activated in the Cotton cycles, the sensors in the new Sensor System come into operation. They affect both the selected temperature, keeping it at a constant level throughout the wash cycle, and the mechanical function of the drum.

The drum is made to turn at two different speeds at crucial moments. When the detergent enters the garments, the drum rotates in such a way that the detergent is distributed in a uniform manner. However, during the wash and rinse procedures, the speed increases in order to maximise the cleaning action. Thanks to this special system, the efficiency of the wash procedure is improved **WITHOUT ANY INCREASE IN THE LENGTH OF THE PROGRAM.**

## ***Sensitive Care***

By pressing this button you can activate a special new wash cycle in the Colourfast and Synthetics programmes, thanks to the new Sensor System. This option treats with care the fibres of garments and the delicate skin of those who wear them.

The load is washed in a much larger quantity of water and this, together with the new combined action of the drum rotation cycles, where water is filled and emptied, will give you garments which have been cleaned and rinsed to perfection. The amount of water in the wash is increased so that the detergent dissolves perfectly, ensuring an efficient cleaning action. The amount of water is also increased during the rinse procedure so as to remove all traces of detergent from the fibres.

This function has been specifically designed for people with delicate and sensitive skin, for whom even a very small amount of detergent can cause irritation or allergy.

You are advised to also use this function for children's clothing and for delicate fabrics in general, or when washing garments made of towelling, where the fibres tend to absorb a greater quantity of detergent.

To ensure the best performance for your wash, this function is always activated on the Delicates and Woollens programmes.

### **Delay Start**

This option is available to delay the start of the wash cycle by up to 9 hours. The selection of the time is completed by pressing the Delay Start button, the countdown display will indicate the time selected. When the correct delay is selected press the Start Pause button to start the cycle.

### **Temperature**

The Temperature button allows the reduction in the wash temperature in each programme. Each time the button is pressed the temperature decreases until a minimum of 15°C (cold wash )

Note: The temperature must be adjusted before selecting **Wash Time**.

### **Fast Iron**

This option is **only** available on the Synthetics, Acrylics, Woolmark and Silk programmes.

<b>Programme</b>	<b>Fast Iron function</b>	<b>Action required to complete the cycle</b>
Synthetics	The programme is completed by a short spin of very low speed.	To select a full spin cycle please turn the dial to the required spin programme.
Acrylics	The machine stops in the final rinse stage and the option indicators blink. The load is held in the water in the drum, thus reducing creasing and enabling easier ironing.	Press the Fast Iron button to continue with the programme. The machine will then pump out the water and the programme will conclude with a short spin. Finally, the programme carries out a brief tumbling action to loosen the items in the load.
Woolmark	The machine stops in the final rinse stage and the option indicators blink. The load is held in the water in the drum, thus reducing creasing and enabling easier ironing.	Press the Fast Iron button and the machine will pump out the water and complete the cycle with a short spin cycle.
Silk	The machine stops in the final rinse stage and the option indicators blink. The load is held in the water in the drum, thus reducing creasing and enabling easier ironing.	Press the Fast Iron button and the machine will pump out the water to complete the cycle. The load will <b>not</b> be spun and will therefore be very wet.

### **Spin Speed**

The spin cycle is very important to remove as much water as possible from the laundry without damaging the fabrics. You can adjust the spin speed of the machine to suit your needs. By pressing the Spin Speed button, it is possible to reduce the maximum spin speed, and if you wish, the spin cycle can be cancelled. To re-activate the spin cycle it is enough to press the button until the required spin speed is indicated.

It is not possible to select a spin speed higher than that suitable for the programme selected. This feature is designed to avoid damaging the fabrics. It is possible to modify the spin speed at any time without stopping or pausing the machine.

## Automatic Features

### Automatic Variable Capacity (Half Load)

The washing machine is fitted with a self adjusting water level system. This system enables the machine to use the optimum amount of water needed to wash and rinse the laundry in relation to the particular load. This results in a reduction of the water and electricity used without in any way compromising the washing and rinsing performance. The amount of water and electricity used will always be appropriate for the clothes load.

The washing machine automatically ensures excellent washing results at minimum cost whilst respecting the environment.

### Out of Balance protection

This model is fitted with an electronic sensor device that checks if the load is balanced correctly. If the load is slightly unbalanced the machine will re-balance it automatically to then carry out the normal spin.

If, after several attempts, balance is not restored a reduced spin speed will be used.

If loads are seriously unbalanced the spin stage will be cancelled. This helps limit vibration, reduce noise and improve the washing machine's reliability and life.

## Programme Selector

For handling the various types of fabric and their level of soiling in your laundry the washing machine has different programme groups according to type of wash, temperature, spin speeds and duration (see Programme Guide).

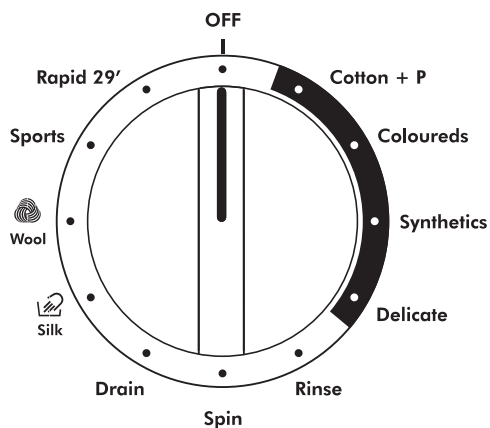

### Cotton and Coloureds

The Cottons programmes are designed for maximum washing and rinsing. With spin cycles in between, they guarantee the laundry is rinsed perfectly. The final spin cycle ensures laundry is spun dry as much as possible up to the maximum speed.

The Cotton programme includes a Prewash cycle. This option is particularly useful for heavily soiled loads and can be used independently of the main wash programme. Detergent for this programme should be added to the first compartment of the soap drawer labelled "I" (please refer to the section of this manual entitled "The Dispenser"). We recommend you use only 20% of the quantity used for the main wash programme.

### Synthetics

Washing and rinsing performance is optimised through drum rotation speeds and water levels for synthetics and mixed fabrics. The programme will default to 60°C. The delicate spin action minimises creasing. The final spin speed for the synthetics programme is 800rpm

## ***Delicates***

This is a new concept in washing, with a cycle that consists of alternate periods of activity and pauses, particularly suitable for washing very delicate fabrics. Washing and rinsing are carried out using a high water level to provide the best results.

## ***Rinse***

This programme carries out three rinses with an intermediate spin (which can be reduced or excluded by using the Spin Speed option). It can be used for rinsing any type of fabric e.g. use after hand washing.

## ***Spin***

The Spin programme completes the spin at the maximum spin speed, this can be reduced by using the Spin Speed option button.

## ***Drain***

This programme drains out the water.

## ***Silk***

This washing machine also has a gentle Silk and Hand Wash programme. This programme allows a complete washing cycle for garments specified as "Hand Wash only" and laundry items made from silk or specified "Wash as silk" on the fabric label.

The programme has a maximum temperature of 30°C and concludes with 3 rinses, one for fabric conditioner, and no final spin.

## ***Wool***

This is a programme dedicated to washing fabrics labelled with the woolmark symbol . The cycle consists of alternate periods of activity and pauses. Washing and rinsing are carried out using a high water level to provide the best results. The programme has a maximum temperature of 40°C and concludes with 3 rinses, one for fabric conditioner, and a short spin at 800rpm.

## ***Sports***

This washing machine has a unique Sportswear programme.

It is specially designed to wash mixed sportswear fabrics that cannot be washed on hotter programmes and is designed to remove the soiling and staining created by participation in sports activities.

This programme starts with a cold prewash that breaks down and loosens any excess dirt and then washes at a cool 30°C, rinses twice (one is for fabric conditioner) and spins at 800rpm for the best care of your heavily soiled, delicate garments.









Detergent for the prewash part of the programme should be added to compartment I and detergent for the mainwash should be added to compartment II. Follow the instructions given in 'The Dispenser' section.

## ***Rapid 29'***

The 29 minute rapid programme allows a complete washing cycle to be completed in under half an hour with a maximum load of 2kg and a temperature of 40°C. The programme is particularly suited to lightly soiled cottons and mixed fabrics.

When selecting the Rapid 29' programme we recommend you use only 20% of the quantities shown on the detergent pack.

# Programme Guide

Programme		Fabric Type	Maximum Load Size (kg)	Maximum Water Temp (°C)
Cotton + P	 P	Cottons and linen	6	90
Coloureds		Cottons, colourfast mixed fabrics	6	60
Synthetics		Mixed fabrics and synthetics	2	60
Delicate		Delicate fabrics	1.5	40
Rinse			-	-
Spin			-	-
Drain			-	-
Silk		Silks and 'Hand Wash only' garments	1.5	30
Wool		Machine washable wool 	1	40
Sports		Mixed fabrics	2.5	30
Rapid 29'		Lightly soiled cottons and mixed fabrics	2	40

Energy label data based on Colourfast programme tested in accordance with CENELEC EN60456

# A Typical Wash

This section summarises the main points when completing a wash cycle. For detailed explanations of features, options and details of the machine refer to the relevant section in the instruction manual.

## ***Preparing the laundry***

Select and sort the laundry according to the wash care labels found on each garment. Always check the care labels.

## ***Loading the laundry***

Open the door.

Put the laundry in the washing machine. Close the door by pushing it until it clicks, ensuring that no items of laundry are obstructing the lock or door seal.

## ***Putting detergent in machine***

Open the drawer, choose the detergent and put in the recommended amount.

**Do not exceed the dosage stated below**

Compartment	Wash	Maximum quantity of powder/liquid
I	Prewash (option)	100ml
II	Main Wash (all programmes)	200ml
	Fabric Conditioner	200ml

Close the drawer again.



**Liquid detergents and some concentrated powders and tablets that are to be placed directly into the drum should be placed in the recommended dispensing device.**

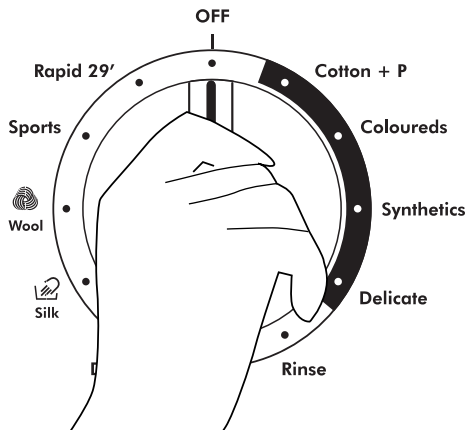

## Selecting the wash programme

Refer to the Programme Guide or the programme descriptions on the front of the machine to select the most suitable programme.

The programme is selected by turning the programme selector and aligning the programme name with the indicator.

Check that the END indicator is flashing, if not check that the door is properly closed.

Check that the tap is turned on and that the discharge hose is positioned correctly.

### Select the required wash options

## Starting the wash cycle

Press the Start Pause button. The door locked indicator and the START light illuminate and then after a few seconds the programme will begin.

**Do not try to open the door when the door locked indicator is on.**

**Do not open the dispenser drawer during the wash programme.**

If you wish to pause the programme press the Start Pause button; after two minutes you will be able to open the door. To cancel the programme the programme selector should be turned to the OFF position. A new programme can be selected after cancelling the previous programme.

### When the programme has finished

Wait approximately two minutes for the door lock to be released. When the door locked indicator light goes out it will then be safe to open the door.

Switch off the machine by turning the programme selector to the OFF position so that it will be ready the next time you use the machine (this action resets the memory in the machine).

Open the door.

Remove the laundry.

Disconnect the plug from the mains power supply and turn off the water supply whenever you finish using it.

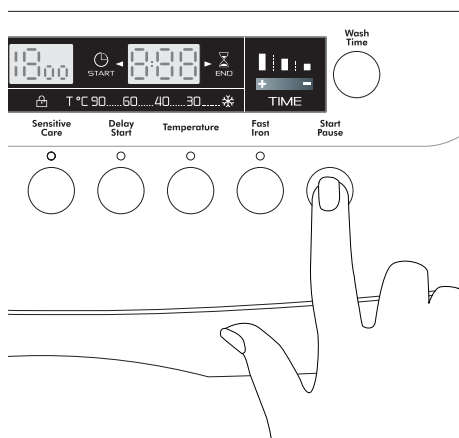



# ***Cleaning and Routine Maintenance***

The washing machine needs very little maintenance, but regular attention to a few small details will ensure the continued performance of your washing machine.

Do not use abrasive cleaners, scouring pads, solvent based cleaners or polishes; wiping the outside of the machine with a damp cloth will suffice.

## ***Cleaning the soap dispenser***

1. Clean the compartments occasionally to remove detergents and additives.
2. To do this you just need to pull the drawer out firmly from the machine, but without forcing it.
3. Clean the compartments and the syphon cover under warm running water.
4. Clean the outlet of the soap dispenser to remove any residue of soap powder
5. Replace the drawer.

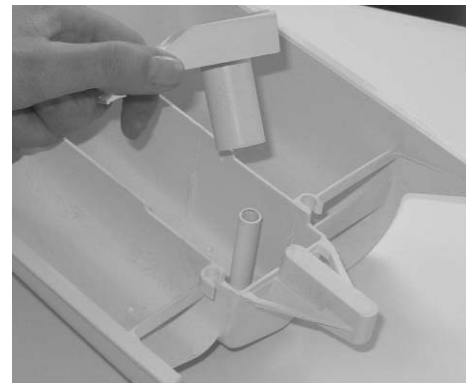

## ***Cleaning the door glass***

Regularly clean the door glass with a damp cloth. A build up of soiling and residues from the water may result in water leaking from the door.

Do not use abrasive cleaners as they can scratch the surface.





### ***Cleaning the filter***

The washing machine is fitted with a special filter to prevent items such as coins, buttons, etc. blocking the discharge hose. These may be retrieved by:

1. Removing the kickplate by gently pulling it from the bottom in an outwards and upwards direction.
2. Use the kickplate to collect the water still in the filter.
3. Use a screwdriver to loosen the screw holding the filter, turn the filter anticlockwise until it stops, remove it and clean it. After cleaning it, reassemble following the above instructions in reverse order.



Replace the kickplate.

**We recommend that the filter be cleaned frequently, at least once a month.**



### ***Maintenance wash***

Using small quantities of detergent and low temperature wash programmes can cause the gradual build up of grease, dirt and scale. Over time these deposits can damage your laundry and your machine. They can also cause your machine to smell. We recommend that you carry out a maintenance wash a couple of times per year to keep your machine and pipe work clean and free of these deposits. Simply run the Cottons 90°C programme without a load and with the normal quantity of detergent.

***This wash will take approximately 2 hours to complete.***

# Troubleshooting

## *What might be the cause of...*

### *Defects you can remedy yourself*

Before calling GIAS Service for technical advice please run through the following checklist. A charge will be made if the machine is found to be working or has been installed incorrectly or used incorrectly. If the problem persists after completing the recommended checks, please call GIAS Service (tel: 08705 400 600), they may be able to assist you over the telephone.

### *The machine will not start...*

- Close the door. Check that there is power to the machine. Select a programme and press Start Pause. Check if the door locked light is illuminated.

**If it is not, check the following:**

1. Is the machine connected to the electrical supply?
  2. Is the electrical supply OK, check another socket?
  3. Has the fuse on the machine blown? If so, replace it.
- If the door locked light is illuminated and the machine does not start this means that the machine cannot fill with water, check the following:
    1. Check the programme dial is correctly aligned with the programme.
    2. Is the water supply to the machine switched on?
    3. Are the pipes kinked or restricted in any way?

### *Water does not drain away... (error 3 will be displayed)*

- Ensure that there is not a blockage in the drain hose or the hose is not kinked.
- Is the drain hose installed correctly? If connected to the sink waste make sure you have cut the membrane or removed the bung from the under sink drainage unit.
- Check for foreign bodies in the filter. If present, clean the filter.

**If you have found any of the above problems correct them and run the machine through a spin cycle to drain the water.**

### ***Water on the floor around the washing machine....***

- Is the fill hose tightened? If so, replace the rubber washers and re-tighten.
- Is the standpipe or the household drain blocked? If so, clear the blockage yourself or call a plumber.
- Is there clothing or dirt between the door gasket and the door glass? Ensure that the door glass and gasket are kept clean and free of laundry when loading the machine.

### ***The machine does not spin...***

- Water has not drained from the machine? Check the points highlighted above.
- Have you selected an option that changes the spin profile (change of spin speed on the selector)? Check the feature in the description of the controls.
- Is the load unbalanced? To reduce noise and vibration and improve the machine's reliability and life, the machine is fitted with an electronic sensor that detects if the load is unbalanced. To improve the spin performance the load can be re-distributed by hand at the end of the cycle and then re-spun.

### ***The machine is noisy or vibrates a lot during the cycle...***

- Has the transit system been fully removed? Check that the bracket and the polystyrene packing have been taken off the machine.
- Are there any loose items in the pockets of clothing that can rattle in the drum and cause damage?
- Is the load unbalanced? Stop the programme, re-distribute the load and restart.

### ***The programme takes a long time...***

- Some programmes do take a long time (over 2 hours). Low water pressure can increase the length of the programme.

### ***The door will not open...***

- Has the programme finished?  
Is the END light illuminated? If not the programme is not complete.  
Has the door locked light gone out? If not wait a further couple of minutes and the light will go out and you will be able to open the door.

- Has the programme finished but the door remains locked? The display reads Error 2. Turn the machine to OFF to reset the machine and this will allow the door to open.
- If water remains in the drum refer to 'Water does not drain away...' above.

### ***Problem with the dispenser...***

- Not all the detergent has been flushed away.
  1. Check the water supply tap is fully turned on.
  2. Check the inlet hose is not kinked.
- The dispenser drawer will not close properly.
  1. Check the drawer is aligned properly
  2. Check the drawer is not clogged with detergent (see Cleaning and routine maintenance)
- Steam is coming from the dispenser.  
The machine is designed to vent through the drawer, this is nothing to worry about.

Remember, you may be charged for the service call if incorrect installation or misuse causes a problem with your machine.

If the following error codes are displayed, switch OFF the machine and contact GIAS Service: 0, 1, 4, 5, 7, 8 and 9.

### **Note:**

The use of environmentally-friendly, phosphate-free detergents (check detergent information on pack) can have the following effects:

- Waste water from rinsing may be cloudier because of the presence of a white powder (zeolites) held in suspension, without the rinse performance being adversely affected.
- Presence of white powder on laundry after washing, which is not absorbed by the fabric and does not alter the colour of the fabric.
- The presence of foam in the final rinsing water is not necessarily an indication of poor rinsing. Carrying out more rinse cycles does not serve any purpose in such cases.

## ***Power Failure***

If there is a power failure the wash cycle will be interrupted, and the wash programme and functions will be suspended. When the power is restored, the wash programme and functions will re-start from the same point and complete the programme.

During a power failure the water can be drained and the load can be removed from the machine as follows:

1. Switch off the machine both via the programme knob and the mains power supply. Remove the plug from the mains power supply socket.
2. Carefully move the machine so the rear of the machine is accessible. Please follow the safety precautions which we recommend under the Safety Notes section of this manual.
3. Unclip the drain hose from the rear panel of the machine and lower the hose into a bowl on the floor. When the bowl is full raise the end of the drain pipe to a height higher than the top of the appliance to stop the flow of water. Empty and replace the bowl and continue draining the machine until empty.
4. Once the machine is fully drained of water, clip the hose to the rear of the machine. Press the door button and remove the load.

The door can be opened approximately 2 minutes after the power failure.

**Do not force open the door.**

# ***Customer Service***

For a period of one year from the date of purchase the appliance is covered by a guarantee which allows you to call Hoover Service free of charge (except for the price of the call).

***Phone GIAS on  
08705 400 600***

Remember to send off the guarantee certificate for validation within 10 days of the date of purchase.

You should retain the receipt issued by the retailer when you purchased the machine to show to the call out engineer, should you need to consult one.

If your washing machine shows signs of a defect or is not working properly, before you contact GIAS Service we recommend you carry out the checks detailed within the Troubleshooting section.

If the problem with the machine persists after completing all the recommended checks, please dial the GIAS Service number.

You will be connected directly to GIAS. It is important you tell the GIAS advisor your product's model number and serial number, which you will find on the rating label (16 characters, beginning with the number 3), found on the front of the washing machine (door area). By doing this, your enquiry will be responded to more efficiently.

# Your Guarantee

Hoover guarantees all parts of this product for 5 years from the date of purchase. During that time Hoover will replace or repair all defective parts free of charge, except for parts subject to fair wear and tear such as belts. The call out fee and labour costs are chargeable after the first 12 months. To qualify for benefits under the guarantee, you must be able to provide proof of date of purchase and the appliance must have been installed and used in accordance with the instructions described in this manual. Consequential losses and accidental damage to the machine is not covered by the guarantee.

Hoover cannot be responsible for the results of using this machine for any purposes other than those described in this manual.

This guarantee does not effect your statutory or common law rights.

For service and repairs please call our national number:

***GIAS Service - Tel: 08705 400 600***  
***Support Service [Eire 018301 666]***

Always use genuine Hoover spares, available direct from GIAS Service:

***Hoover Spares Service***  
***Tel: 01204 556111***

## ***Hoovercare***

To maintain your Hoover product in peak condition you may wish to take out a Hoovercare policy, which for an annual payment provides a comprehensive maintenance and repair scheme. For more information please call 08705 400 600.

The Hoovercare scheme is not available in Eire.

The manufacturer declines all responsibility in the event of any printing mistakes in this booklet. The manufacturer also reserves the right to make appropriate modifications to its products without changing the essential characteristics.