

Instruction Book

Vented Tumble Dryer

HOOVER

VisionHD

*Vented
System*

English



Contents

Introduction	3
Delivery information	3
Unpacking the Product	3
Safety reminders	4
Installation	4
Use	4
The Laundry	4
Environmental Issues	5
GIAS Service	5
European Directive 2002/96/EC	5
Installation	6
Electrical requirements	6
Adjusting the feet	6
Ventilation	7
Installation of the Discharge Hose	7
Preparing the load	9
Clothes preparation	9
Sorting the load	9
Drying advice	10
Do not tumble dry	10
Energy saving	10
Controls and indicators	11
Door and Filter	12
Opening the door	12
Filter	12
Filter care indicator	12
Selecting the Programme	13
Operation	14
Cancelling and resetting the programme	14
Cleaning and Routine Maintenance	15
Cleaning the dryer	15
Technical specifications	15
Troubleshooting	16
Customer Service	17
Hoover Spares	17
GIAS Service	17
Your Guarantee	18
Hoovercare	18

Introduction

Please read and follow these instructions carefully and operate the machine accordingly. This booklet provides important guidelines for safe use, installation, maintenance and some useful advice for best results when using your machine.

Keep all documentation in a safe place for future reference or for any future owners.

Delivery information

Please check that the following items are delivered with the appliance:

- Instruction manual
- Guarantee card
- Vent kit and instructions
- Energy label

Unpacking the product

Remove the machine from its packaging close to the final location of the machine.

1. Cut carefully around the base of the packaging and up one corner.
2. Remove the polythene sleeve and lift the dryer off the polystyrene base.



Check that no damage has occurred to the machine during transit. If it has, call for service by GIAS.

**Call
08705 400 600**

If the appliance is not running properly or breaks down, switch it off, disconnect the plug from the socket and do not tamper with the appliance. Consult GIAS Service for possible repair.

**Call
08705 400 600**

Failure to comply with the above can compromise the safety of the appliance. You may be charged for a service call if a problem with your machine is caused by misuse.

Dispose of the packaging safely. Make sure it is out of the reach of children, it is a potential source of danger.

Safety reminders

Installation

- Check that the product has no visible signs of damage before use. If damaged do not use and please call GIAS Service.
- Do not use adapters, multiple connectors and/or extensions.
- Never install the dryer against curtains and be sure to prevent items from falling or collecting behind the dryer.
- The appliance must not be installed behind a lockable door, a sliding door or a door with a hinge on the opposite side to that of the tumble dryer.

Use

- This appliance is not intended for use by persons (including children) with reduced physical, sensory or mental capabilities, or lack of experience and knowledge, unless they have been given supervision or instruction concerning use of the appliance by a person responsible for their safety.
- Children should be supervised to ensure that they do not play with the appliance.
- **WARNING** Misuse of a tumble dryer may create a fire hazard.
- This machine is solely for domestic use, i.e. to dry household textiles and garments.
- This machine should only be used for its intended purpose as described in this manual. Ensure that the instructions for installation and use are fully understood before operating the appliance.
- Do not touch the appliance when hands or feet are damp or wet.
- Do not lean on the door when loading the machine or use the door to lift or move the machine.
- Do not allow children to play with the machine or its controls.
- **WARNING** Do not use the product if the fluff filter is not in position or is damaged; fluff could be ignited.
- **WARNING** Where the hot surface symbol  is located the temperature rise during operation of the tumble dryer may be in excess of 60 degrees C.
- Remove the plug from the electricity supply. Always remove the plug before cleaning the appliance.
- Do not continue to use this machine if it appears to be faulty.
- Lint and fluff must not be allowed to collect on the floor around the outside of the machine.
- The drum inside may be very hot. Always allow the dryer to complete the cool down period before removing the laundry.

The Laundry

- Do not dry unwashed items in the tumble dryer.
- **WARNING** Do not tumble dry fabrics treated with dry cleaning fluids.
- **WARNING** Foam rubber materials can, under certain circumstances, when heated become ignited by spontaneous combustion. Items such as foam rubber (latex foam), shower caps, waterproof textiles, rubber backed articles and clothes or pillows fitted with foam rubber pads **MUST NOT** be dried in the tumble dryer.

- Always refer to the laundry care labels for directions on suitability for drying.
- Clothes should be spin dried or thoroughly wrung before they are put into the tumble dryer. Clothes that are dripping wet should **NOT** be put into the dryer.
- Lighters and matches must not be left in pockets and **NEVER** use flammable liquids near the machine.
- Glass fibre curtains should **NEVER** be put in this machine. Skin irritation may occur if other garments are contaminated with the glass fibres.
- Items that have been soiled with substances such as cooking oil, acetone, alcohol, petrol, kerosene, spot removers, turpentine, waxes and wax removers should be washed in hot water with an extra amount of detergent before being dried in the tumble dryer.
- Fabric softeners, or similar products, should be used as specified by the fabric softener instructions.

Environmental Issues

- All packaging materials used are environmentally-friendly and recyclable. Please help dispose of the packaging via environmentally-friendly means. Your local council will be able to give you details of current means of disposal.
- To ensure safety when disposing of an old tumble dryer disconnect the mains plug from the socket, cut the mains power cable and destroy this together with the plug. To prevent children shutting themselves in the machine break the door hinges or the door lock.

GIAS Service

- To ensure the continued safe and efficient operation of this appliance we recommend that any servicing or repairs are only carried out by an authorised GIAS service engineer.

European directive 2002/96/EC

This appliance is marked according to the European directive 2002/96/EC on Waste Electrical and Electronic Equipment (WEEE).

By ensuring this product is disposed of correctly, you will help prevent potential negative consequences for the environment and human health, which could otherwise be caused by inappropriate waste handling of this product.

The symbol on the product indicates that this product may not be treated as household waste. Instead it shall be handed over to the applicable collection point for the recycling of electrical and electronic equipment.

Disposal must be carried out in accordance with local environmental regulations for waste disposal.

For more detailed information about treatment, recovery and recycling of this product, please contact your local city office, your household waste disposal service or the shop where you purchased the product.



Installation

Do not plug the machine in and switch it on at the mains until the installation is completed.

You may be charged for a service call if a problem with your machine is caused by incorrect installation.

If the mains cord on this appliance is damaged, it must be replaced by a special cord which is ONLY obtainable from the Hoover spares service. It must be installed by a competent person.

**Call
01204 556111**

Electrical requirements

Tumble dryers are supplied to operate at a voltage of 230-240V, 50 Hz single phase. Check that the supply circuit is rated to at least 13A.

This appliance is fitted with a moulded-on non-rewireable plug which is already equipped with a BS 1362 ASTA approved 13A fuse. Any replacement must be the same rating and specification. **If the fuse cover is lost, do not use the plug until it is replaced.**

Electricity can be extremely dangerous.

This appliance must be earthed.

The socket outlet and the plug on the appliance must be of the same type.

Do not use multiple adapters and/or extension leads.

The plug should be accessible for disconnection after the appliance has been installed.

The wires in the mains lead are coloured in accordance with the following codes:

Blue	NEUTRAL
Brown	LIVE
Green and Yellow	EARTH

CE Appliance complies with European Directive 89/336/EEC, 73/23/EEC and subsequent amendments.

Adjusting the feet

Once the machine is in place the feet should be adjusted to ensure that the machine is level.

Adjust the four feet to ensure the machine is firm and level.

Ventilation

Adequate ventilation must be provided in the room where the tumble dryer is located to prevent gases from appliances burning other fuels, including open fires, being drawn into the room during operation of the tumble dryer.

- Exhaust air must not be discharged into a flue which is used for exhausting fumes from appliances burning gas or other fuels.
- Check regularly that the air flowing through the dryer is not restricted.
- Check the fluff filter after use, and clean, if necessary.
- The inlet and outlets should be kept free from obstructions. To ensure adequate ventilation the space between the bottom of the machine and the floor must not be obstructed. There should be a gap of at least 12mm between the machine and any obstructions.
- Prevent items from falling or collecting behind the dryer as these may obstruct the air inlet and outlet.
- **NEVER** install the dryer up against curtains.



Installation of the Discharge Hose

It is essential to use a venting hose to carry the hot moist air away from the dryer unless the dryer is situated in a open space with a good air flow around it. Re-recirculation of the moist air will prevent the efficient operation of the dryer.

The hose is assembled to the machine as shown opposite.

The hose may be fitted through a wall or through an open door or window. The hose is 110mm in diameter and will extend 1.8 meters.

The following guidelines should be followed when installing the discharge hose.

- Do not use two hoses joined together as the drying performance will be reduced.



**For your safety, this dryer must be correctly installed.
If there is any doubt about installation, call the national GIAS Service
number for advice.**

**08705 400 600
(Eire 018301 666)**

- Do not restrict the flow of air through the hose e.g. by kinking it or fitting a smaller diameter connector to mount to a wall opening.
- Avoid the hose making U shaped curves as this will restrict the flow of air and increase the chance that water will collect in the hose.
- Check the hose regularly to remove any build-up of fluff or water that may have collected in it.

The following diagrams give examples of good and bad installations.

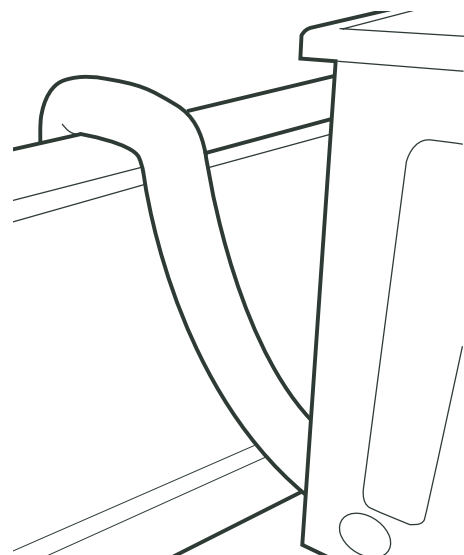
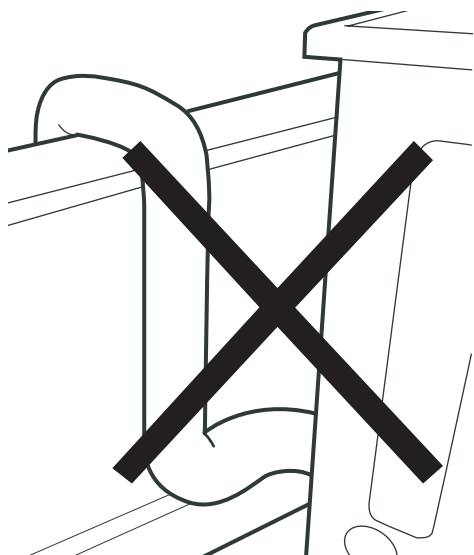
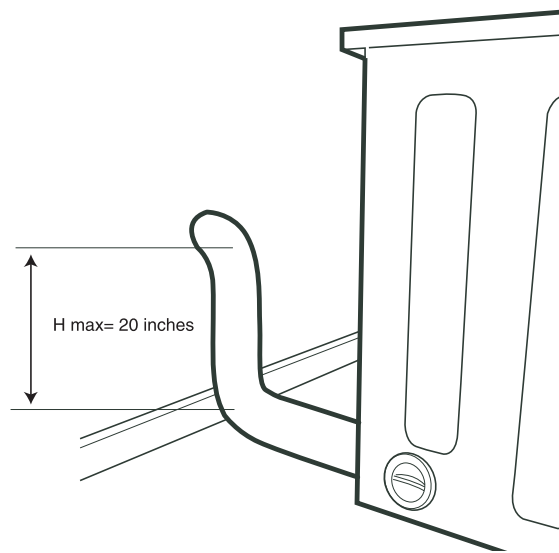
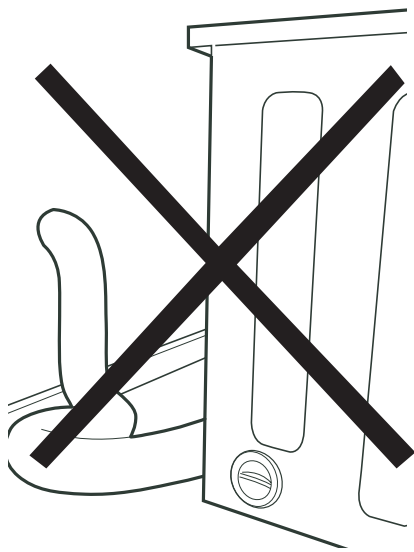

Preparing the load

Before using the tumble dryer for the first time:

- Please read this instruction book thoroughly.
- Remove all items packed inside drum.
- Wipe the inside of the drum and door with a damp cloth to remove any dust which may have settled in transit.

Clothes preparation

Make sure that the laundry you are going to dry is suitable for drying in a tumble dryer, as shown by the care symbols on each item.

Check that all fastenings are closed and that pockets are empty. Turn the articles inside out. Place clothes loosely in the drum to make sure that they don't get tangled.





Maximum drying weight

- Cottons Max. 8 kg
- Synthetics Max. 4 kg

Do not overload the drum, large items when wet can exceed the maximum admissible clothes load (for example: sleeping bags, duvets).

Sort the load as follows:

- **By care symbols**
These can be found on the collar or inside seam:

-  Suitable for tumble drying.
-  Tumble drying at high temperature.
-  Tumble drying at low temperature only.
-  Do not tumble dry.

If the item does not have a care label it must be assumed that it is not suitable for tumble drying.

- **By amount and thickness**
Whenever the load is bigger than the dryer capacity, separate clothes according to thickness (e.g. towels from thin underwear).
- **By type of fabric**
Cottons/linen: Towels, cotton jersey, bed and table linen.
Synthetics: Blouses, shirts, overalls, etc. made of polyester or polyamid, as well as for cotton/synthetic mixes.
- **By drying level**
Sort into: iron dry, cupboard dry, etc. For delicate articles press the 'ACRYLICS/SYNTHETICS' button to select low drying temperature.

Drying advice

IMPORTANT: Do not dry articles which have been treated with a dry cleaning fluid or rubber clothes (danger of fire or explosion).

Do not tumble dry:

Woollens, silk, delicate fabrics, nylon stockings, delicate embroidery, fabrics with metallic decorations, garments with PVC or leather trimmings, training shoes, bulky items such as sleeping bags, etc.

Energy saving

Only put into the tumble dryer laundry which has been thoroughly wrung or spin-dried. The drier the laundry the shorter the drying time thus saving electricity.

ALWAYS

- Try to dry the maximum weight of laundry, this will save time and electricity.
- Check that the filter is clean before every drying cycle.

NEVER

- Exceed the maximum weight, this will waste time and electricity.
- Put dripping wet items into the tumble dryer, this may damage the appliance.

During the last 15 minutes the load is always tumbled in cool air.

Controls and indicators

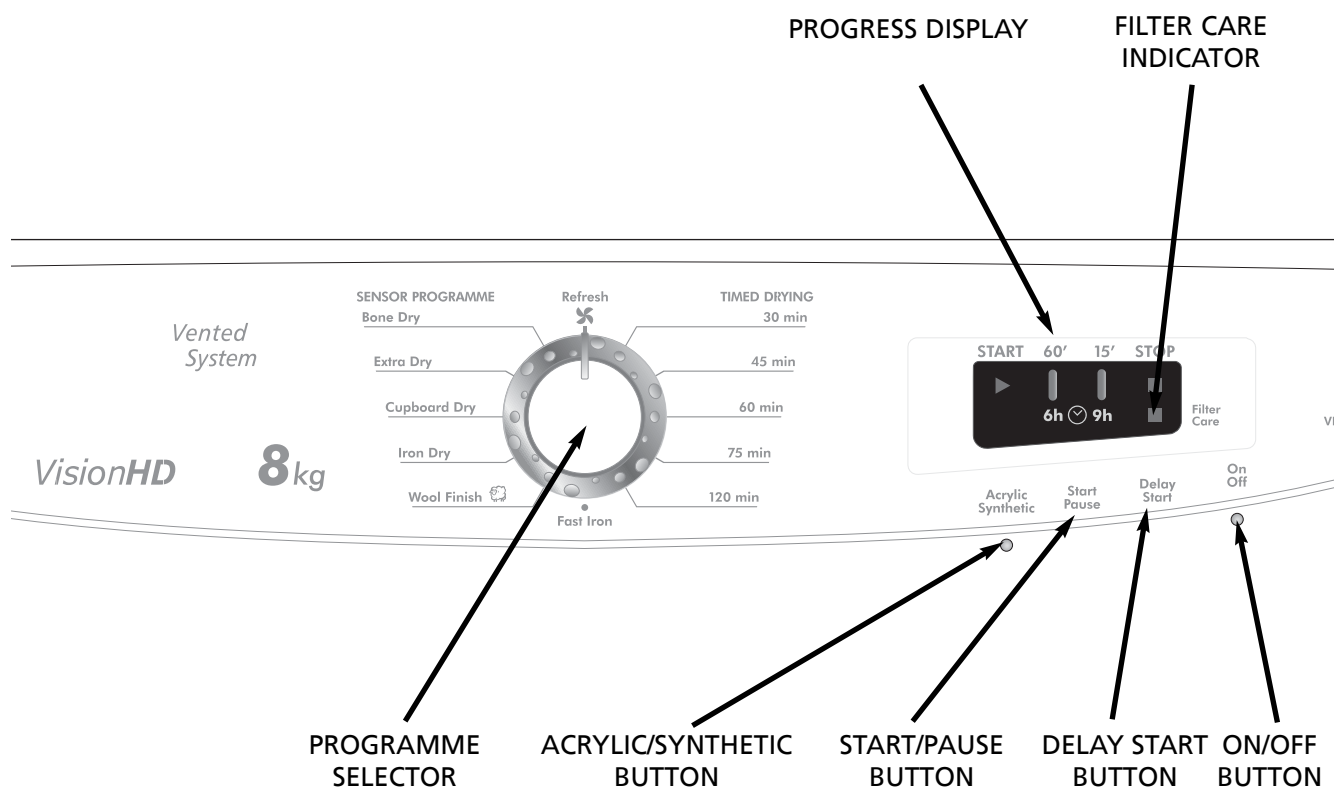

Control panel and indicator lights

Programme Selector – select the required programme

On/Off button and indicator – press to switch on, the indicator will light

Delay Start button – allows the user to delay the start of the drying cycle (see details of Operation on page 16)

Start/Pause button – press Start/Pause to commence the selected drying programme

Acrylic/Synthetic button – press to reduce the heat level for delicate items, the indicator above the button will light up. To change the heat setting the programme must be reset.

Low Heat – Indicator light **ON**

High Heat – Indicator light **OFF**

FILTER CARE Indicator – lights when the filter needs cleaning

Progress display

START – When the dryer is switched On the START indicator will flash, when the programme starts the START indicator will light up

60' – Indicator lights when there is less than 60 minutes left until completion of the programme

15' – Indicator lights when there is less than 15 minutes left until completion of the programme. At this stage of the drying cycle the machine enters the Cool down phase

STOP – Indicator lights when the programme is finished.

Door and Filter



Opening the door

Pull on handle to open the door.

To restart the dryer, close the door and press the Start/Reset button.

WARNING!

When the tumble dryer is in use the drum and door may be **VERY HOT**. Never stop a tumble dryer before the end of the drying cycle unless all items are quickly removed and spread out so that the heat is dissipated

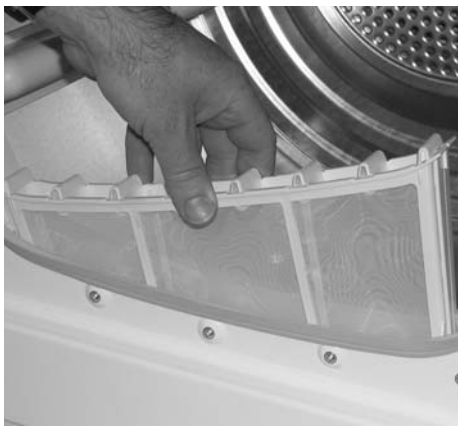

Filter

IMPORTANT: To maintain the efficiency of the dryer check that the fluff filter is clean before each drying cycle.

1. Pull the filter upwards.
2. Open filter as shown.
3. Gently remove lint using a soft brush or your fingertips.
4. Snap the filter together and push back into place.

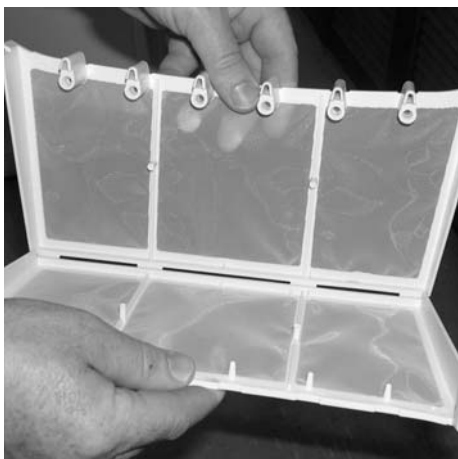

Filter Care Indicator

Lights when the filter needs cleaning.

If the laundry is not drying check that the filter is not clogged. The indicator will also light when the venting hose is blocked or kinked.

Selecting the Programme

The Hoover Sensor Dry machine gives many options for drying the laundry to suit all circumstances.



The table below lists the programmes and the function of each programme.

Note: The sensor may not detect a small load of small articles. For small loads and separate items or pre-dried fabrics with low moisture content, use the timed programmes. Set the programme between 30 and 75 minutes depending on the load size and dryness required, and select high or low heat depending upon the fabric type.

If the sensor does not detect the item the dryer will only operate for 10 minutes before going into cooldown.

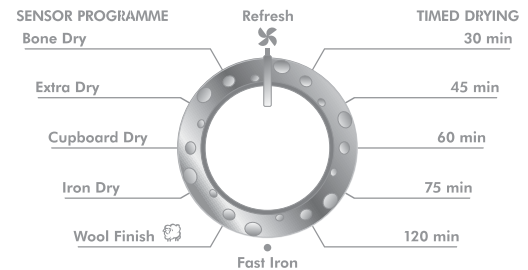
If the load is too large or too wet to tumble dry the dryer will automatically go into cooldown after 185 minutes.



Programme	Description
Bone Dry	Select the degree of dryness that you require.
Extra Dry	This ranges from Bone Dry for bath towels and bathrobes, through Cupboard Dry for items that will be put away without ironing, to the programme that leaves the laundry suitable for ironing.
Cupboard Dry	
Iron Dry	
Wool 	A gentle programme specially created to get woollens softer after air-drying. This delicate warm air cycle, lasting 12 minutes, can also be used to get woollens 'refreshed' after being stored in the wardrobe.
Fast Iron	The Fast Iron programme provides a conditioning and anticrease function. The dryer will heat the load for 9 minutes followed by a 3 minute cool down period and is especially good for garments which may have been left for some time prior to ironing, in a linen basket for example. Garments may also become stiffened when dried outside on a washing line or inside on radiators. The Fast Iron process relaxes the creases in the fabric making ironing quicker and easier.
120'	120 minutes of drying
75'	75 minutes of drying
60'	60 minutes of drying
45'	45 minutes of drying
30'	30 minutes of drying
Refresh 	Tumbling of laundry in cool air for 30 minutes

Operation

1. Open the door and load the drum with laundry. Ensure that garments do not hinder closure of the door.
2. Gently close the door pushing it slowly until you hear the door 'click' shut.
3. Press the 'On/Off' button to switch on the dryer. The On/Off indicator will light up and the START indicator will flash.
4. Turn the Programme Selector dial to select the required drying program (see Programme Guide).
5. If drying synthetics, acrylics or delicate items, press the Acrylics/Synthetics button to reduce the heat level. The light above the push button will light up when the machine is in low heat setting. To deselect this status the machine must be reset.
6. Press the 'START' button. The dryer will start automatically and the START indicator will be continuously lit.
7. The progress display will show the drying progress in terms of time remaining.
8. If the door is opened during the programme to check the laundry, it is necessary to press START to recommence drying after the door has been closed.
9. When the 15' indicator is lit the machine will enter the cool down phase, the clothes will be tumbled in cool air allowing the load to cool down.
10. When the programme is complete the STOP indicator will light.
11. Following the completion of the cycle the drum will rotate intermittently to minimise creasing. This will continue until the machine is reset or switched OFF.

WARNING!
The drum, door and load may be very hot.

Cancelling and resetting the programme

To cancel a programme switch the machine off and on again. The machine will indicate that it has been reset by the START indicator flashing.

Cleaning and Routine Maintenance

Cleaning the dryer

- Clean the filter after every drying cycle.
- After each period of use, wipe the inside of the drum and leave the door open for a while to allow circulation of air to dry it.
- Wipe the outside of the machine and the door with a soft cloth.
- **DO NOT** use abrasive pads or cleaning agents.
- To prevent the door sticking or the build up of fluff periodically clean the inner door and gasket with a damp cloth.

IMPORTANT

Always switch off and remove the plug from the electricity supply before cleaning this appliance.

Technical specifications

Drum capacity	115 litres
Maximum load	8 kg
Height	85cm
Width	60cm
Depth	60cm
Energy Label Band	C

For electrical data refer to the rating label on the front of the dryer cabinet (with the door open).

Troubleshooting

What might be the cause of...

Defects you can remedy yourself

Before calling GIAS Service for technical advice please run through the following checklist. A charge will be made if the machine is found to be working or has been installed incorrectly or used incorrectly. If the problem persists after completing the recommended checks, please call the GIAS Service (tel: 08705 400 600), they may be able to assist you over the telephone.

Drying time is too long/clothes are not dry enough...

- Have you selected the correct drying time/programme?
- Were the clothes too wet? Were the clothes thoroughly wrung or spin-dried?
- Does the filter need cleaning?
- Is the dryer overloaded?
- Is the venting hose kinked or blocked?
- Has the 'ACRYLICS/SYNTHETICS' option been selected from a previous cycle?

The dryer does not operate...

- Is there a working electricity supply to the dryer? Check using another appliance such as a table lamp.
- Is the plug properly connected to the mains supply?
- Is there a power failure?
- Has the fuse blown?
- Is the door fully closed?
- Is the dryer switched on, both at the mains supply and at the machine?
- Has the drying time or the programme been selected?
- Has the machine been switched on again after opening the door?

The dryer is noisy...

- Switch off the dryer and contact the GIAS service number 08705 400 600 for advice.

The Filter Care Indicator is on...

- Does the filter need cleaning?
- Is the venting hose kinked or blocked?

Customer Service

Note:

If the supply cord on this appliance is damaged, it must be replaced by a special cord which is only available from GIAS Service or an authorised Hoover Dealer.

Should there still be a problem with your dryer after completing all the recommended checks, please call the national GIAS Service number for advice. They may be able to assist you over the telephone or arrange for a suitable appointment for an engineer to call under the terms of your guarantee. However, a charge may be made if any of the following applies to your machine:

- Is found to be in working order.
- Has not been installed in accordance with the installation instructions.
- Has been used incorrectly.

GIAS Service - Tel: 08705 400 600
Support Service for Eire - Tel: 018301 666

HOOVER Spares

Always use genuine Hoover spares, available direct from GIAS Service.

Hoover Spares Service
Tel: 01204 556111

GIAS Service

For service and repairs call your local engineer on our national number.

Phone GIAS on
08705 400 600
Eire-018301 666

Your Guarantee

For a period of one year from the date of purchase the appliance is covered by a guarantee which allows you to call GIAS Service free of charge.

Remember to send off the guarantee certificate for validation within 10 days of the date of purchase.

You should retain the receipt issued by the retailer when you purchased the machine to show to the call out engineer, should you need to consult one.

If your appliance shows signs of a defect or is not working properly, before you contact GIAS Service we recommend you carry out the checks detailed within the Troubleshooting section.

If the problem with the appliance persists after completing all the recommended checks, please dial the GIAS Service number.

You will be connected directly to GIAS. It is important you tell the GIAS advisor your product's model number and serial number, which you will find on the rating label (16 characters, beginning with the number 3), found on the front of the appliance (door area). By doing this, your enquiry will be responded to more efficiently.

Hoover guarantees all parts of this product for 5 years from the date of purchase. During that time Hoover will replace or repair all defective parts free of charge, except for parts subject to fair wear and tear such as belts. The call out fee and labour costs are chargeable after the first 12 months. To qualify for benefits under the guarantee, you must be able to provide proof of date of purchase and the appliance must have been installed and used in accordance with the instructions described in this manual. Consequential losses and accidental damage to the machine is not covered by the guarantee.

Hoover cannot be responsible for the results of using this machine for any purposes other than those described in this manual.

This guarantee does not affect your statutory or common law rights.

Note: If repair work has been completed by an unauthorised engineer the product guarantee may become invalid.

Hoovercare

To maintain your Hoover product in peak condition you may wish to take out a Hoovercare policy, which for an annual payment provides a comprehensive maintenance and repair scheme. For more information please call 08705 400 600.

The Hoovercare scheme is not available in Eire.

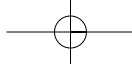

The manufacturer declines all responsibility in the event of any printing mistakes in this booklet. The manufacturer also reserves the right to make appropriate modifications to its products without changing the essential characteristics.

