

HOOVER



GB INSTRUCTIONS FOR USE AND INSTALLATION

IT ISTRUZIONI D'USO E DI INSTALLAZIONE

PT MANUAL DE UTILIZAÇÃO E DE INSTALAÇÃO



Pour les appareils comme :Code 33800315

All these characteristics are given for information with a constant concern for improving production quality, the manufacturer may make modification to the appliance to incorporate technical improvements.



The hobs are in conformity with directives 89/336/CEE, 73/23/CEE and 90/396/CEE.

CONTENTS

Unpacking the appliance	2
Recommendations	2-3
Hob features	3
• INSTALLATION	
Safety instructions	4
<u>Modification of the factory gas setting :</u>	
* Fitting of the correct jets	5
Fitting the hob	6
Gas connection	7
Electrical connection	8
<u>After final installation of the hob (if modification of the gas setting) :</u>	
Adjusting of the lower flame on the gas burners	9
• USING THE APPLIANCE	
The different gas burners	10
Igniting and setting the burner	11
The hot plate - some tips	12-13
General maintenance	14-15

UNPACKING THE APPLIANCE

Inside the appliance, you will find :

- a plastic bag containing :
 - the new jets for the gas modification, if required,
 - according to model, a cylindrical connector and/or a conical connector with seal for the gas connection,
 - the fixing brackets with screws required for installing the hob in the worktop.

RECOMMENDATIONS

TO GET THE BEST FROM YOUR APPLIANCE, PLEASE READ THE FOLLOWING CAREFULLY.

Please keep the operating and installation instructions in a safe place for future reference. Before fixing the hob, note the serial number of the appliance just in case you should require future repairs from our after sales service organisation at some time in the future.

Rating plate (located under the lower casing of the hob)



Product code :
Serial no :

- All accessible parts of the hob will become hot while in operation. Always keep children away from it.
- The hob should be given a quick clean after each use, to avoid the accumulation of spillages and grease. If spillages are not removed, they will harden, and could cause the production of smoke and unpleasant smells.
- When cooking with fats or oils, never leave gas burner unattended. Overheated fats or oils can quickly catch fire.

HOB FEATURES

Rapid 2,5 kW or
hot plate,
according to the model

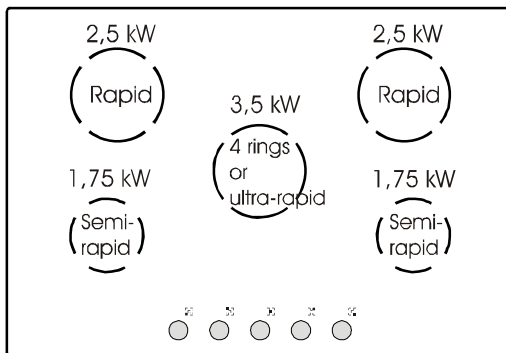
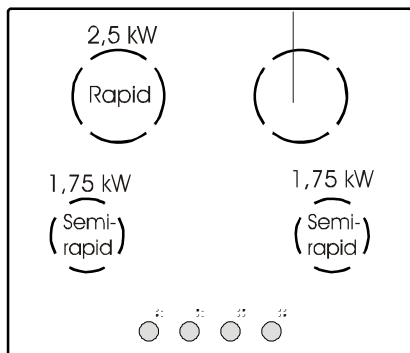

MODELS 60 cm

MODELS 75 cm

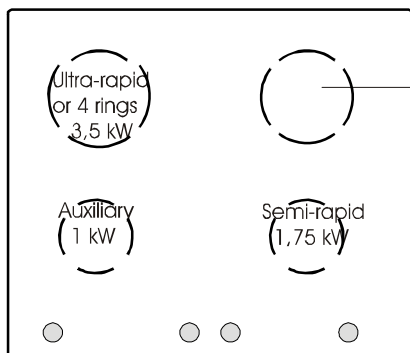

Rapid 2,5 kW or
hot plate,
according to the model

INSTALLATION

Installing a domestic appliance can be a complicated operation which if not carried out correctly, can seriously affect consumer safety.

It is for this reason that the task should be undertaken by a professionally qualified person who will carry it out in accordance with the technical regulations in force.

In the event that this advice is ignored and the installation is carried out by an unqualified person, the society declines all responsibility for any technical failure of the product whether or not it results in damage to goods or injury to individuals.

Before installing the hob :

- ① make sure that the appliance is compatible with the gas supply source.
The hob is pre-set in the factory to work with the type of gas shown on the packing and the plate attached to it.
Natural gas G 20-20 mbar / G 25-25 mbar : mains gas
- ② if necessary, adapt the hob for use with another type of gas : if the hob must be used with another type of gas than the gas pre-set in the factory, it is necessary to adapt the hob gas burners (page 5).
The procedure for adaptation consists of :
. fitting the correct jets to ensure nominal delivery.

For installation,

- ③ built-in hob (page 6).
- ④ make the gas connection according to the type of gas to be used : based on the gas to be used, choose the appropriate gas connection (page 7).
- ⑤ make the hob electrical connection according to the instructions (page 8).
- ⑥ adjusting the minimum flame of the taps : if necessary, adjust the minimum flame of the taps by turning the by-pass screw (page 9).

All modification concerning the hob gas setting must be indicated on the rating plate of the hob.

INSTALLATION: «GAS CONNECTION»

	GAZ/GAS	G20	G25	G 30	G 31
		20 mbar	25 mbar	29 mbar	37 mbar
CAT. I12H3+	GB-IT-PT-ES	☐		X	X
CAT. I12E+3+	FR	☐	☐	X	X

☐ = Factory setting: Natural gas = G20-20 mbar / G25-25 mbar

X = Gas setting possible according to installation Butane gas G30-29 mbar or Propane gas G 31-37 mbar

CHANGING THE GAS TYPE : the calorific power output and gas pressure will vary according to the gas supply. Burner setting must be carried out once the gas and electrical installation is complete.

When changing gas type, you must follow the procedure below :

- . fit the correct jets,
- . adjust the minimum flame on the taps.

CHANGING THE JETS

To gain access to the jets, remove the pan supports, and remove the burner cap and body, Take a spanner and unscrew the jet. According to the table below, fit the correct jet for the type of gas to be used, Secure the jet tightly, Replace the burner body, cap and the pan support.



Each jet is designated by size.

		HOB BURNERS									
		auxiliary		semi-rapid		rapid		ultra-rapid	4 Rings		
Gas	mbar	Jet	kW	Jet	kW	Jet	kW	Jet	Jet	kW	
*	G 20	20	76	1,00	101	1,75	118	2,50	144	141	3,50
*	G 25	25	76	0,90	101	1,60	118	2,30	144	141	3,20
	G 30	29	50	1,00	66	1,75	80	2,50	94	96	3,50
	G 31	37	50	1,00	66	1,75	80	2,50	94	96	3,50
* Factory setting: G 20-20 mbar - G 25-25 mbar											

INSTALLATION : «BUILDING-IN»

Both the worktop where the hob will be fitted and any adjacent kitchen furniture must be made from heat resistant material and fixed with heat resistant adhesive.

If, when installing the hob, the lower hob face is adjacent to an area normally accessible when handling or cleaning, fit a heatproof partition 1 cm below the base of the hob with a 10X10 cm opening at the rear right-hand corner, to avoid any risk of scorching or damage. A foam adhesive is supplied with the hob. Stick this seal under the edge of the body as near as possible to the outer edge of the hob. Press round the edges of the hob, so that the seal flattens out and ensures an air tight seal.

• BUILDING-IN

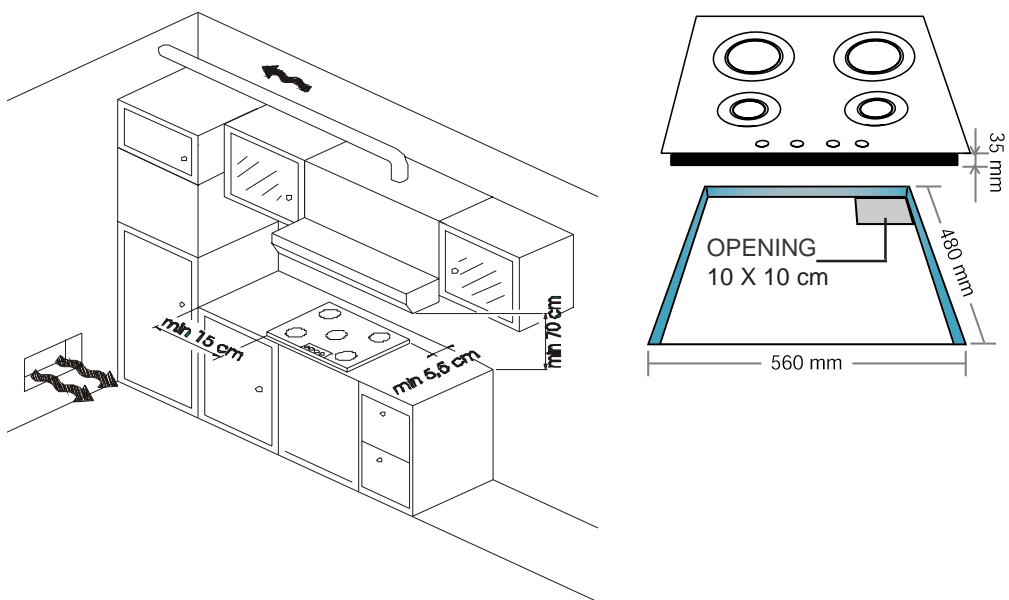

The body of the hob is fitted with 4 location holes to take the fixing brackets that secure the hob in the unit. Place the 4 fixing brackets in such a way that the hob is placed perfectly in the support unit.

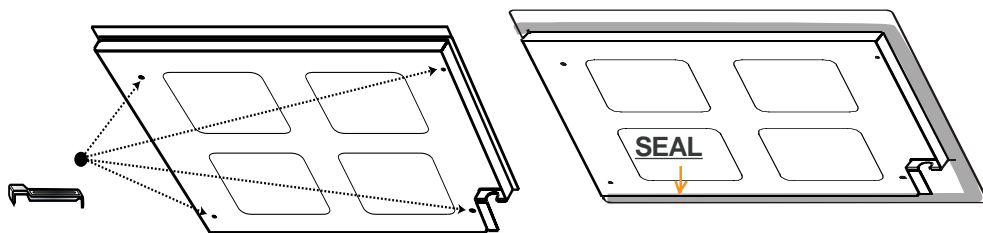

INSTALLATION: «GAS CONNECTION»

The hob can be built-in ; it is in class 3 (in compliance with gas regulations EN 30.1.1) ; adjoining furniture should not be higher than the level of the hob.

This appliance is not connected to an evacuation device for the products of combustion. It must be installed and connected in compliance with the norms in force in the country of installation. Particular attention should be given to the availability of ventilation.

The turnover of air necessary for combustion is a minimum of 2 m³/h per kW of power.

Gas connection should be carried out in compliance with the norms in force in the country of installation. A stop tap, a regulator valve or a release valve for propane gas, should be fitted to the gas supply pipe. Use only taps, regulator valves, connectors and flexible hoses with the official mark of approval of the country of installation.

Built-in appliance

Butane Rigid - Flexible pipe with mechanical connectors (1) -

Propane Rigid - Flexible pipe with mechanical connectors (1) -

Natural Rigid - Flexible pipe with mechanical connectors (1) -

(1) on condition that the hose is accessible along the whole of its length it should be located so it cannot be reached by naked flame or affected by combustion gases. Neither should it be near hot parts of the hob nor anywhere where hot spillages could affect it.

2 POSSIBLES MEANS OF CONNECTION :

Fit the appliance with the cylindrical or the conical gas adaptor, in accordance to the installation Country standards, and then proceed to the connection, two possibilities:

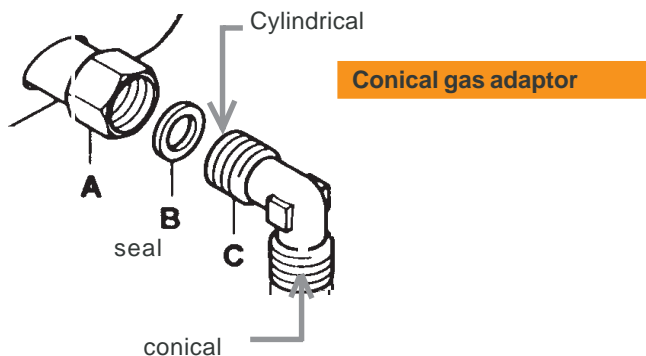

• CONNECTION BY RIGID PIPE

Connect directly to the threaded end of the inlet pipe.

• CONNECTION BY FLEXIBLE PIPE WITH MECHANICAL CONNECTOR

Screw the nuts of the flexible pipe directly on to the inlet pipe at one end and the gas supply stop tap at the other.

We recommend this type of connection.

INSTALLATION: «ELECTRICAL CONNECTION»

The mains electricity supply connected to the appliance should comply with the norms in force in the country of installation.

Connection to the mains electricity supply should be through a socket with an earth terminal, or through an intermediary switching device with a gap between contacts of at least 3 mm.

The power supply unit must be protected by appropriate fuses and use cables of a large enough cross section to provide a normal supply to the appliance.

The hob is fitted with a power supply cable* without plug which allow it to be connected only to a power supply of 230 V between phases, or between phase and neutral.

- **Connect to a 10/16 Amp socket. Before connecting, it is compulsory to check :**
 - . the power supply voltage shown on the electricity meter,
 - . the adjustment of the circuit breaker, and
 - . the fuse rating 10A.

Note : the socket must be reachable for any eventual repair. Take care of its location at the time you install the hob.

Warning : before proceeding with the connection, check the continuity of the earthing of the power supply unit.

We cannot be held responsible for any accident which has resulting from the use of an appliance which is not connected to earth, or whose earthing is defective.

* The eventual replacement of the supplying cord must be carried on by the After Sales Service or by an agreed engineer, with a cord whose characteristics must be similar to the original one.

INSTALLATION: «REGULATING THE FLAME»

• SETTING THE IDLE FLAME

If you have changed the type of gas, it is important to verify the flame stability at the minimum regulation.

«Gaining access to the by-pass screw»

To gain access to hob burner by-pass screws, remove the knobs from the control panel.



Never loosen
the others screws !

By-pass screw of the hob burner



REGULATING THE MINIMUM FLAME ON THE HOB BURNER

a) Natural gas :

- . simply loosen the screw.
- . switch on the burner and turn the knob to minimum.
- . Turn the by-pass screw until a low flame is visible. Turn the control knob from minimum to maximum position to check that it is satisfactory.

b) Butane-propane gas :

The by-pass screw should be screwed fully home, without being locked.

THE GAS BURNER

THE ULTRA-RAPID BURNER or "4 RINGS" BURNER, power rating 3,5 kW :

use this burner for bringing to boil, for cooking large quantities, and generally for all foods requiring rapid cooking.

THE FAST BURNER, power rating 2,5 kW :

use the large burner for all foods requiring rapid cooking.

THE SEMI-FAST BURNER, power rating 1,75 kW or THE AUXILIARY BURNER, power rating 1kW :

it is ideal for stewing, sauces and slow cooking.

The pan supports fitted on the 1,75 kW burners are working as Mijorose when the burner is set on low rate.

On the slow setting, the flame only comes into contact with the cast iron burner cap. This is ideal for slow cooking, as the heat is evenly distributed under the pan and food doesn't dry out or stick to the bottom of the pan.

On the high position, the flames heat directly the pan allowing all cookings on quick gas.

For a proper use of the burners, choose pans which match the dimensions given below :

*** Ultra-rapid or "4 Rings" Ø 18 cm and more**

*** Rapid Ø 16 to 18 cm**

*** Semi-fast Ø 12 cm**

*** Auxiliary Ø 10 cm**

SOME TIPS

- Pans with curved, ridged or warped bottoms are not recommended.
- Centre the pan on the "pan support".
- Do not place the same pan on two burners.
- Avoid boiling food too intensely. Food is not cooked any more quickly this way. In fact, it is subjected to severe agitation, which may cause the food to lose some of its flavour.
- To save gas, make sure that the flames do not overlap the bottom of the pan.
- Do not use the gas burner with an empty pan.

WARNING :

. when the burners are not in service, the general gas supply tap should always be turned off.

. the use of a steak-grid is forbidden. The high temperatures reached on the hob surface will give to the glass a thermic shock which will lead to an irreversible brittleness.

Each burner is fitted with automatic ignition. The ignition can be made with one hand, while you have the pan in the other hand.

USE :

- Turn on the gas tap,
- A symbol next to each control knob indicates which burner is lit. (example: front left burner)

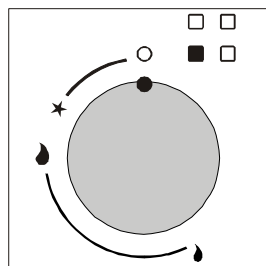

Hob with automatic ignition integrated :

- Press and turn the knob to position "★" keeping it pressed to produce sparks which in turn ignite the burner.

Hob with safety device on the burner and automatic ignition integrated :

The thermocouple fast safety is a device allowing the automatic cut-out of the gas supplying on the burner, in case the flame dies out accidentally.

- Press and turn the knob to position "**high flame**" keeping it pressed to produce sparks which in turn ignite the burner.

Keep the pressure on the control knob a few seconds to permit the releasing of the safety device.

- Set the flame according to your cooking requirements. Intermediate positions are available between the settings on the control knob.
- To turn the flame out, turn the control knob back to stop position.

Please note :

. If there is a power cut, the burner can be ignited by pressing in and turning the knob to position "**high flame**" and holding a naked flame to the burner.

Caution:

the heating surface clearly get hot while operating, so make sure that small children are kept well away from the hob.

THE HOT PLATE

THE SPEED PROTECTED HOT PLATE - 1500 W.

This is a cast-iron hot plate, controlled by a 7 position switch.

An internal thermostat cuts off part of the power supply if overheating occurs. (if, for example, a hot plate is working without a pan on it).

BEFORE USING THE ELECTRICAL HOT PLATE :

- Before using the electric hot plate for the first time, let it heat up for a few minutes, without a pan, at maximum temperature to allow the protective coating to harden.

HOW TO USE :

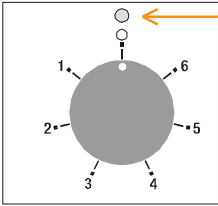

- For best results, it is advisable to start on the maximum heat and then turn back to an intermediate temperature taking into account the type and volume of the food.
- An indicator light comes on to show that the hot plate is operating.
- To switch off, turn the knob back to point "O".

DIFFERENT TEMPERATURE SETTINGS :

Below are a few examples which are given as guidelines. When you become more familiar with the appliance, you will be able to choose settings to suit your own personal tastes and requirements.

Positions		Some tips
1	Very low	To keep a dish hot, melt butter and chocolate
2	Low	Slow cooking, sauces, stews, rice pudding, poached eggs ...
3	Moderately	Beans, frozen foods, fruit, boiling water
4	Medium	Steamed apples, fresh vegetables, pasta, crepes, fish
5	High	More intense cooking, omelettes, steaks
6	Very high	Steaks, chops, frying...

Cooking with the electrical hot plate

To get the best results from your appliance it is important to observe the following :

- Use thick, flat-based cooking vessel :
a completely flat base prevents overheating to certain parts which causes food to stick. Thick metal allows for good heat distribution.
- Make sure that the base of the pan is dry :
this will prevent sticking to the hot plate caused by moisture.
- Use pans with a diameter large enough to completely cover the hot plate, otherwise energy will be wasted and any spillages will cause the hot plate to become stained and will become difficult to maintain (rust, etc.).
- Never leave a hot plate switched on without a pan on it : it can be damaged, which would reduce its efficiency.
- When cooking with fat or oil, never leave the hob unattended, very hot fats and oils can quickly catch fire.
- When the hot plate is hot, avoid any contact with materials made of plastic or aluminium foil.

Caution :

the heating surfaces clearly get hot while operating, so make sure that small children are kept well away from the hob.

CLEANING THE HOT PLATE

To burn off any cooking deposits heat the hob for a short time. After switching off and the hot plate has cooled down, wipe it with absorbent paper. It is important that the hot plate is protected from moisture.

Do not use abrasive products.

To maintain and preserve its appearance, rub a drop of neutral oil, such as sewing machine oil into the surface of the hot plate.

The hot plate should always be dry, or slightly greasy. If it is not to be used for some time, remove any rust using emery paper followed by a suitable commercially available product for the maintenance of soil hotplates.

CLEANING AND MAINTENANCE

Before cleaning or removing the hob, it is imperative to :

- **disconnect the hob from the mains supply,**
- **let all parts of the hob cool down.**

Never use harsh abrasives, scouring pads or sharp objects to clean the hob.

Do not use a sponge that it is excessively wet.

It is advisable to keep away from the hob all substances which are liable to melt, such as plastic items, sugar, or sugar-based products.

MAINTENANCE OF THE GLASS HOB

- . Place a few drops of the specialised cleaning products on the hob surface.
- . Rub any stubborn stains with a soft cloth or with slightly damp kitchen paper.
- . Wipe with a soft cloth or dry kitchen paper until the surface is clean.

If there are still some stubborn stains :

- . place a few more drops of specialised cleaning fluid on the surface,
- . scrape with a scraper, holding it at an angle of 30° to the hob, until the stains disappear.
- . wipe with a soft cloth or dry kitchen paper until the surface is clean.
- . repeat the operation if necessary.

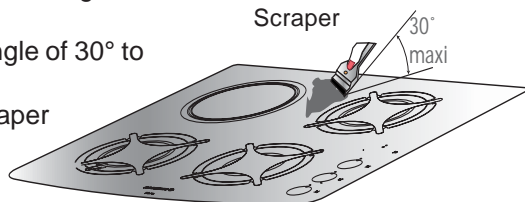

A scraper with a razor blade will not damage the surface, as long as it is kept at an angle of 30° . Never leave a scraper with a razor blade within the reach of children.

A FEW HINTS :

Frequent cleaning leaves a protective layer which is essential to prevent scratches and wear.

Make sure that the surface is clean before using the hob again.

To remove marks left by water, use a few drops of white vinegar or lemon juice. Then wipe with absorbent paper and a few drops of specialised cleaning fluid.

MAINTENANCE OF THE HOB

. **Enamelled steel hob :** when the hob has cooled completely, simply clean the enamelled hob with soapy water, rinse and wipe with a clean dry cloth. If you clean the enamelled hob when it is hot, you may tarnish it.

. **Stainless steel :** clean with soapy water, rinse and dry. You can use a special product to clean stainless steel which is available from various retail outlets. Place a few drops of the specialised cleaning products on the hob surface.

THE GAS BURNERS

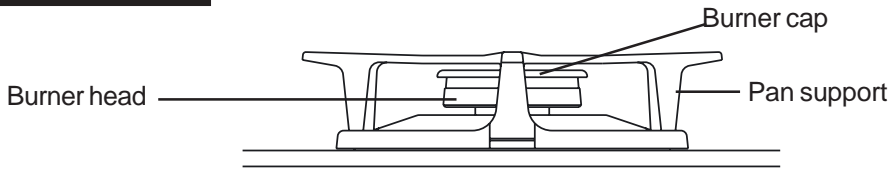

- Burner caps and pan supports : the pan support is made of enamelled cast-iron and the burner cap is made of enamelled steel, for a maximal protection and an easy cleaning. They are simply placed. Just lift them off and clean with a damp, slightly soapy sponge. Do not immerse them in cold water immediately after use to avoid cracking the enamel from the thermal shock.

The use of abrasive cleansers is not recommended as they scratch and dull the enamel.

- The burner head : the burner cap is simply placed on the burner head. If the holes are clogged, brush the caps using soapy water and dry with a clean cloth.

Each burner is simply layed on a flange slightly bossed to drain the overflows far from the flame and the hot areas which make cleaning easier.

- After cleaning of each element, it is important to wipe them correctly and care of fitting them rightly in their initial position. The re-fitting must be perfect because a bad positioning can bring serious anomalies in the combustion.

Warning : be careful, not to let any water get into the burners.

THE KNOBS

- For thorough cleaning, the control knobs can be removed by pulling them upwards. Only clean with soapy water and dry well before replacing them.

- **Do not try to pull the watertightness rings.** They are originally fitted and must not be pulled out.