



BORN INNOVATIVE

EN



Please read and follow these instructions carefully and operate the machine accordingly. This booklet provides important guidelines for safe use, installation, maintenance and some useful advice for best results when using your machine.

Keep all documentation in a safe place for future reference or for any future owners.

Please check that the following items are delivered with the appliance:

- Instruction manual
- Guarantee card
- Energy label

By placing the  mark on this product, we are confirming compliance to all relevant European safety, health and environmental requirements which are applicable in legislation for this product.



Check that no damage has occurred to the machine during transit. If it has, call for service by GIAS. Failure to comply with the above can compromise the safety of the appliance. You may be charged for a service call if a problem with your machine is caused by misuse.

Index

- 1. SAFETY REMINDERS**
- 2. DRAIN HOSE KIT: FITTING INSTRUCTIONS**
- 3. PREPARING THE LOAD**
- 4. CLEANING AND ROUTINE MAINTENANCE**
- 5. WATER CONTAINER**
- 6. DOOR AND FILTER AND CONDENSER**
- 7. CONTROLS AND INDICATORS**
- 8. SELECTING THE PROGRAMME AND SET THE FUNCTION**
- 9. TROUBLESHOOTING CUSTOMER SERVICE**

1. SAFETY REMINDERS

- This appliance can be used by children aged from 8 years and above and persons with reduced physical, sensory or mental capabilities or lack of experience and knowledge if they have been given supervision or instruction concerning use of the appliance in a safe way and understand the hazards involved. Children shall not play with the appliance. Cleaning and user maintenance should not be made by children without supervision. Children of less than 3 years should be kept away unless continuously supervised.
- **WARNING** Misuse of a tumble dryer may create a fire hazard.
- This appliance is intended to be used in household and similar applications such as:
 - Staff kitchen areas in shops, offices and other working environments;
 - Farm houses
 - By clients in hotels, motels and other residential type environments;
 - Bed and breakfast type environments"

A different use of this appliance from household environment or from typical housekeeping functions, as commercial use by expert or trained users, is excluded even in the above applications.

If the appliance is used in a manner inconsistent with this it may reduce the life of the appliance and may void the manufacturer's warranty. Any damage to the appliance or other damage or loss arising through use that is not consistent with domestic or household use (even if located in a domestic or household environment) shall not be accepted by the manufacturer to the fullest extent permitted by law.

- This machine should only be used for its intended purpose as described in this manual. Ensure that the instructions for installation and use are fully understood before operating the appliance.
- Do not touch the appliance when hands or feet are damp or wet.
- Do not lean on the door when loading the machine or use the door to lift or move the machine.
- Do not allow children to play with the machine or its controls.

- **WARNING** Do not use the product if the fluff filter is not in position or is damaged; fluff could be ignited.
- **WARNING** Where the hot surface symbol is  located the temperature rise during operation of the tumble dryer may be in excess of 60 degrees C.
- Remove the plug from the electricity supply. Always remove the plug before cleaning the appliance.
- Do not continue to use this machine if it appears to be faulty.
- Lint and fluff must not be allowed to collect on the floor around the outside of the machine.
- The final part of a tumble dryer cycle occurs without heat (cool down cycle) to ensure that the items are left at a temperature that ensures that the items will not be damaged.
- The tumble dryer is not to be used if industrial chemicals have been used for cleaning.
- **WARNING:** Never stop a tumble dryer before the end of the drying cycle unless all items are quickly removed and spread out so that the heat is dissipated.
- Maximum load drying weight : see energy label.

Installation

- Do not use adapters, multiple connectors and/or extensions.
- Never install the dryer against curtains and be sure to prevent items from falling or collecting behind the dryer.
- The appliance must not be installed behind a lockable door, a sliding door or a door with a hinge on the opposite side to that of the tumble dryer.

The Laundry

- Do not dry unwashed items in the tumble dryer.
- **WARNING** Do not tumble dry fabrics treated with dry cleaning fluids.
- **WARNING** Foam rubber materials can, under certain circumstances, when heated become ignited by spontaneous combustion. Items such as foam rubber (latex foam), shower caps, waterproof textiles, rubber backed articles and clothes or pillows fitted with foam rubber pads **MUST NOT** be dried in the tumble dryer.
- Always refer to the laundry care labels for directions on suitability for drying.
- Clothes should be spin dried or thoroughly wrung before they are put into the tumble dryer.
- Remove all objects from pockets such as lighters and matches.
- Clothes that are dripping wet should not be put into the dryer.
- Lighters and matches must not be left in pockets and **NEVER** use flammable liquids near the machine.
- Glass fibre curtains should **NEVER** be put in this machine. Skin irritation may occur if other garments are contaminated with the glass fibres.
- Items that have been soiled with substances such as cooking oil, acetone, alcohol,

petrol, kerosene, spot removers, turpentine, waxes and wax removers should be washed in hot water with an extra amount of detergent before being dried in the tumble dryer.

- Fabric softeners, or similar products, should be used as specified by the fabric softener instructions.

Ventilation

- Adequate ventilation must be provided in the room where the tumble dryer is located to prevent gases from appliances burning other fuels, including open fires, being drawn into the room during operation of the tumble dryer.
- Installing the rear of the appliance close to a wall or vertical surface.
- There should be a gap of at least 12 mm between the machine and any obstructions. The inlet and outlet should be kept clear of obstruction. To ensure adequate ventilation the space between the bottom of the machine and the floor must not be obstructed.
- Check regularly that the air flowing through the dryer is not restricted.

- Check frequently the fluff filter after use, and clean, if necessary.
- Prevent items from falling or collecting behind the dryer as these may obstruct the air inlet and outlet.
- NEVER install the dryer up against curtains.
- In cases where the dryer is installed on top of a washing machine, a suitable stacking kit must be used according to the configuration of your appliance.

- Stacking kit "standard size": for washing machine with minimum depth of 44 cm;

- Stacking kit "slim size": for washing machine with minimum depth of 40 cm;

The stacking kit shall be obtainable from our spare service.

The instructions for installation and any fixing attachments, are provided with the stacking kit.



WARNING: The appliance must not be supplied through an external switching device, such as a timer, or connected to a circuit that is regularly switched on and off by a utility.

⚠ If the supply cord is damaged, it must be replaced by the manufacturer, its service agent or similarly qualified persons in order to avoid a hazard.

⚠ Do not install the product in a low temperature room or in a room where there is a risk of frost occurring. At temperature around freezing point the product may not be able to operate properly: there is a risk of damage if the water is allowed to freeze in the hydraulic circuit (valves, hoses, pumps). For a better product performance the ambient room temperature must be between 5-35°C. Please note that operating in cold condition (between +2 and +5°C) might simply some water condensation and water drops on floor.

Environmental Issues

- All packaging materials used are environmentally-friendly and recyclable. Please help dispose of the packaging via environmentally-friendly means. Your local council will be able to give you details of current means of disposal.
- To ensure safety when disposing of an old tumble dryer disconnect the mains plug from the socket, cut the mains power cable and destroy this together with the plug. To prevent children shutting themselves in the machine break the door hinges or the door lock.

European Directive 2012/19/EU

This appliance is marked according to the European directive 2012/19/EU on Waste Electrical and Electronic Equipment (WEEE).



WEEE contains both polluting substances (which can cause negative consequences for the environment) and basic components (which can be re-used). It is important to have WEEE subjected to specific treatments, in order to remove and dispose properly all pollutants, and recover and recycle all materials.

Individuals can play an important role in ensuring that WEEE does not become an environmental issue; it is essential to follow some basic rules:

- WEEE should not be treated as household waste.
- WEEE should be handed over to the relevant collection points managed by the municipality or by registered companies. In many countries, for large WEEE, home collection could be present.

In many countries, when you buy a new appliance, the old one may be returned to the retailer who has to collect it free of charge on a one-to-one basis, as long as the equipment is of equivalent type and has the same functions as the supplied equipment.

GIAS Service

- To ensure the continued safe and efficient operation of this appliance we recommend that any servicing or repairs are only carried out by an authorised GIAS service engineer.

Electrical Requirements

Tumble dryers are supplied to operate at a voltage of 220-240V, 50 Hz single phase. Check that the supply circuit is rated to at least 13A.

Electricity can be extremely dangerous.

This appliance must be earthed.

The socket outlet and the plug on the appliance must be of the same type.

Do not use multiple adapters and/or extension leads.

The plug should be accessible for disconnection after the appliance has been installed.

 You may be charged for a service call if a problem with your machine is caused by incorrect installation.

 Do not plug the machine in and switch it on at the mains until the installation is completed. For your safety, this dryer must be correctly installed. If there is any doubt about installation, call GIAS Service for advice.

Adjusting the Feet

Once the machine is in place the feet should be adjusted to ensure that the machine is level.

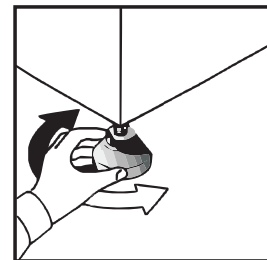

2. DRAIN HOSE : FITTING INSTRUCTIONS FOR TANK IN DOOR DRAWER

To avoid emptying the water container after each drying cycle, the water can be discharged directly to a waste water drain pipe (the same drainage system as household sinks). Water Bye-Laws prohibit connection to a surface water drain. The waste water drain pipe should be located adjacent to the tumble dryer.

The kit consists of: 1 hose and 1 tap.

⚠ WARNING! Switch off and remove the tumble dryer plug from the electricity supply before carrying out any work.

Fit the Hose as Follows:

1. Tilt the machine backwards.

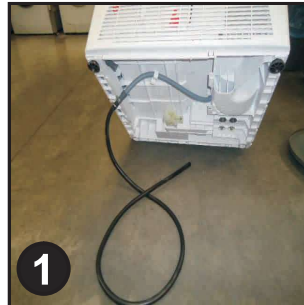

2. The waste water pipe is situated at the right-hand side of the machine (see the picture). A grey hose connects to the bridge at the left hand side of the machine. Using pliers, remove the pipe retaining clip from the bridge.



3. Pull the hose off the bridge connection.



4. Attach the black hose from the kit, (using the connector and pipe clips supplied), to the hose removed from the bridge connection.



5. Place the tap supplied by the kit to close the remaining hose.

Connect the new drain hose to the waste black water pipe.



6. Once the machine is in place, check the bottom to ensure that the new hose does not kink when pushing the tumble dryer into position.



Connect to the mains electricity supply.

⚠ NOTE: The direct drain condensed water kit is suitable only on models with the water tank on the door.

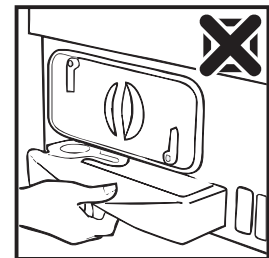
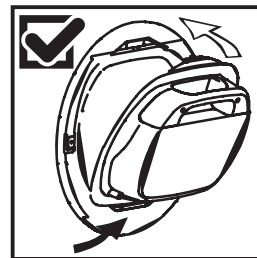

3. PREPARING THE LOAD

Before using the tumble dryer for the first time:

- Please read this instruction book thoroughly.
- Remove all items packed inside drum.
- Wipe the inside of the drum and door with a damp cloth to remove any dust which may have settled in transit.

Clothes Preparation

Make sure that the laundry you are going to dry is suitable for drying in a tumble dryer, as shown by the care symbols on each item.

Check that all fastenings are closed and that pockets are empty. Turn the articles inside out. Place clothes loosely in the drum to make sure that they don't get tangled.

Do Not Tumble Dry:

Silk, nylon stockings, delicate embroidery, fabrics with metallic decorations, garments with PVC or leather trimmings.

 **IMPORTANT:** Do not dry articles which have been treated with a dry cleaning fluid or rubber clothes (danger of fire or explosion).

During the last 15 minutes the load is always tumbled in cool air.

Energy Saving

Only put into the tumble dryer laundry which has been thoroughly wrung or spin-dried. The drier the laundry the shorter the drying time thus saving electricity.

ALWAYS

- Check that the filter is clean before every drying cycle.

NEVER

- Put dripping wet items into the tumble dryer, this may damage the appliance.

Sort the Load as Follows

• By care symbols

These can be found on the collar or inside seam:

 Suitable for tumble drying.

 Tumble drying at high temperature.

 Tumble drying at low temperature only.

 Do not tumble dry.

If the item does not have a care label it must be assumed that it is not suitable for tumble drying.

• By amount and thickness

Whenever the load is bigger than the dryer capacity, separate clothes according to thickness (e.g. towels from thin underwear).

• By type of fabric

Cottons/linen: Towels, cotton jersey, bed and table linen.

Synthetics: Blouses, shirts, overalls, etc. made of polyester or polyamid, as well as for cotton/synthetic mixes.

 Do not overload the drum, large items when wet exceed the maximum admissible clothes load (for example: sleeping bags, duvets).

4. CLEANING AND ROUTINE MAINTENANCE

Cleaning the Dryer

- Clean the filter and empty the water container after every drying cycle.
- Regularly clean the condenser.
- After each period of use, wipe the inside of the drum and leave the door open for a while to allow circulation of air to dry it.
- Wipe the outside of the machine and the door with a soft cloth.
- DO NOT use abrasive pads or cleaning agents.
- To prevent the door sticking or the build up of fluff clean the inner door and gasket with a damp cloth after every drying cycle.

 **WARNING!** The Drum, door and load may be very hot.

 **IMPORTANT** Always switch off and remove the plug from the electricity supply before cleaning this appliance.

 For electrical data refer to the rating label on the front of the dryer cabinet (with the door open).

5. WATER CONTAINER

The water removed from the laundry during the drying cycle is collected in a container inside the door of the dryer. When the container is full the 'Water' indicator on the control panel will light, and the container **MUST** be emptied. However, we recommend that the container is emptied after each drying cycle.

NOTE: Very little water will collect during the first few cycles of a new machine as an internal reservoir is filled first.

To remove the container tank in door drawer

1. Gently pull out the water container holding the handle. **(A)**

When it is full the water container will weigh about 6 kg.

2. Tilt the water container to empty the water out through the spout. **(B)**

When empty, replace the water container back as shown; **(C)** first insert the base of the container into position as shown **(1)** then gentle push the top into position **(2)**.

3. Press  Button to restart the cycle.

NOTE: If you have the option of drainage near to the dryer you can use the discharge kit to provide a permanent drainage for the water collected in the container of the dryer. This means that you don't have to empty the water container.

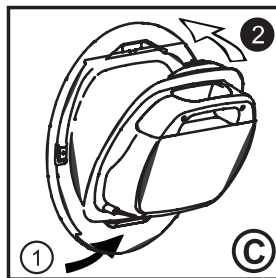
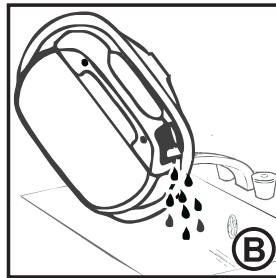
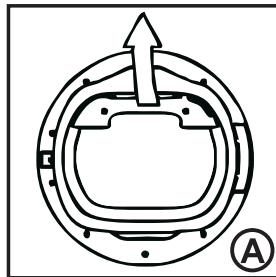

To remove the container bottom water drawer

1. Gently pull the bottom of the kickplate so that it unclips from the dryer. The top section can then be unhinged allowing the kickplate to be completely removed. **(A)**

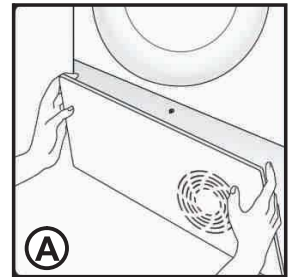

2. Pull firmly on the handgrip and slide the water container out of the dryer. **(B)**

Support the container with both hands. **(C)** When full, the water container will weigh about 4kg.

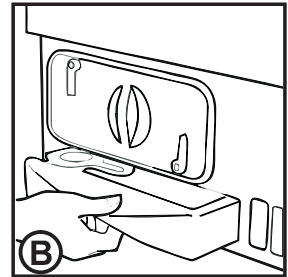

3. Open the lid located on the top of the container and empty the water. **(D)**

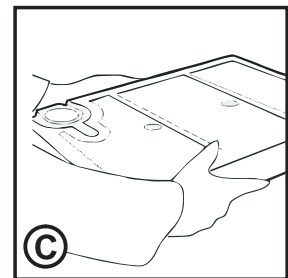

4. Refit the lid and slide the water container back into position. **(D)**

PUSH FIRMLY INTO PLACE.

5. Refit the kickplate by engaging the hinges at the top and 'snapping' the lower clips into place.

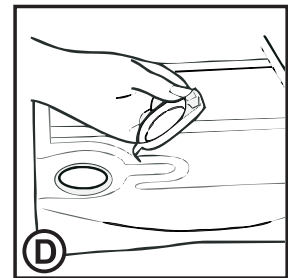

6. DOOR AND FILTER

Pull on handle to open the door.
To restart the dryer, close the door and press Start / Pause button. ▶▶▶

⚠ WARNING! When the tumble dryer is in use the drum and door may be VERY HOT.

Filter

IMPORTANT: To maintain the efficiency of the dryer check that the fluff filter is clean before each drying cycle.

1. Pull the filter upwards.

2. Open filter as shown.

3. Gently remove lint using a soft brush or your fingertips.

4. Snap the filter together and push back into place.

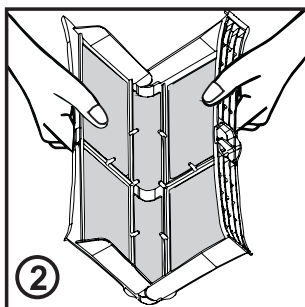
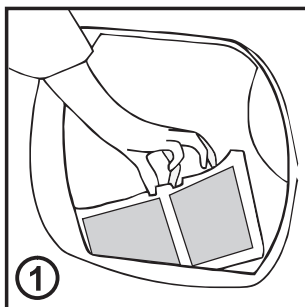

Filter Care Indicator

🌐 Lights when the filter needs cleaning.

If the laundry is not drying check that the filter is not clogged.

⚠ IF YOU CLEAN FILTER UNDER WATER, REMEMBER TO DRY IT.

⚠ WARNING! If you open the door mid cycle, before the cool-down cycle has completed, the handle may be hot. Please use extreme caution when attempting to empty the water reservoir during the cycle.

To Remove the Condenser

1. Remove the kickplate.

2. Turn the two locking levers anti-clockwise and pull out the condenser.

3. Pull out the condenser unit.

4. Gently remove any dust or fluff with a cloth, then wash the unit by holding it under a running tap turning it so that water flows between the plates, to remove any dust or fluff.

5. Check the gasket position after cleaning. Fit the gasket in to the groove if it is misaligned.

6. Refit the condenser ensuring it is in the correct way (as indicated by the arrow) and pushed firmly into place. Lock the two levers by turning them clockwise. Be sure that condenser unit fixed to the basement tightly.

7. Refit the kickplate.

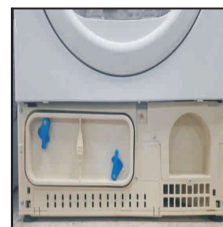
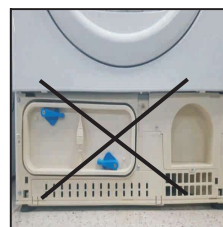
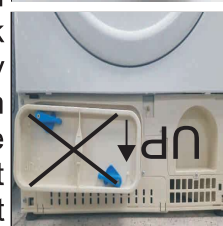
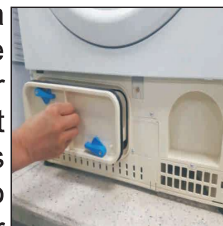
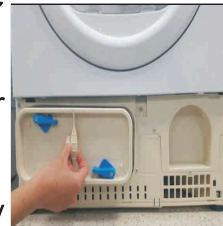

7. CONTROLS AND INDICATORS

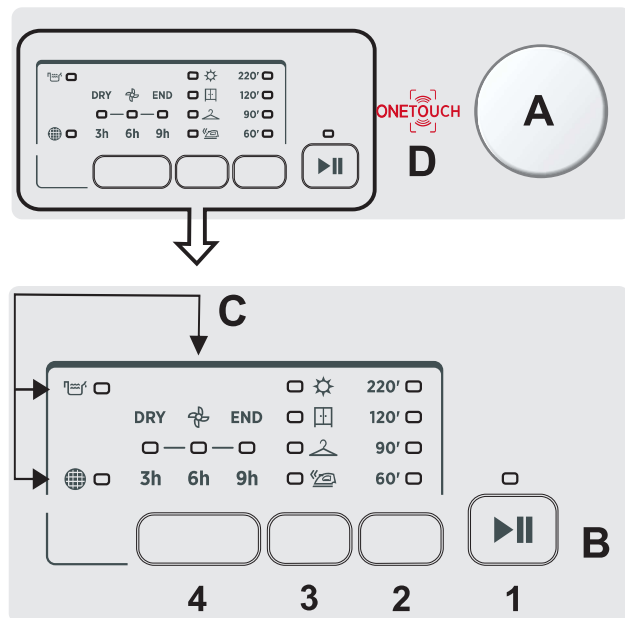

A-Programme Selector -

Rotating the knob in both directions it's possible to select the desired drying program. To switch or cancel off the dryer rotate the knob on OFF.

B-Buttons -

1.Start/Pause Button

To start the selected program and/or suspend it.

2.Time cycle selection

It's possible switch a cycle from automatic to timed, up to 3 minutes after the start of the cycle. After this selection to reset the automatic drying functioning is necessary to switch off the dryer.

3.Drying Selection Button

It allows to set the desired dryness level editable option up to 5 minutes after the starting of the cycle:

- **Ready to Iron** : It leaves the garments slightly wet to facilitate ironing.

- **Dry Hanger** : To get garment ready to be hang.

- **Dry wardrobe** : For laundry that can be directly stored.

- **Extra-dry** : To get completely dry garments, ideal for full load.

This appliances is equipped with Drying Manager Function. On automatic cycles, each level of intermediate drying, prior to the reaching the selected one, is indicated by flashing the light indicator corresponding to the degree of drying reached.

4.Delay Start Button

To postpone the start of the programm for 3h, 6h, or 9h. Opening of the porthole with delayed start set, after re-closing the porthole, press start again to resume the counting.

C-Led

Water tank - It lights up when it's necessary to empty the condensate water tank.

Filter cleaning - It lights up when the cleaning of the filters is requested (the door and the lower filter).

These control lights, light up for indicate the drying phase:

-**DRY**: It lights up when the drying cycle is running.

- It light up when the cycle is in the cooling phase.

-**END**: It light up when the cycle is done.

D-

ONE TOUCH area - pressing the START/PAUSE button allows to a previously downloaded cycle to start whilst the Touch position is selected on the programme knob (for downloading cycles from the App see the relevant section of this user manual).

Automatic Anti crease

This option automatically activates an anti-creases movement of the drum, pre cycle in case of activation of the delay and at the end of drying cycle for 6 hours. It is activated every 10 minutes. To stop the movements set the knob to OFF.

Useful when it's not possible to remove immediately the laundry.



APPAREL CARE

The wool drying cycle of this machine has been approved by The Woolmark Company for the drying of machine washable wool products provided that the products

are washed and dried according to the instructions on the garment label and those issues by the manufacturer of this machine. M1524.

In UK, Eire, Hong Kong and India the Woolmark trade mark is a Certification trade mark.

Information for Test Laboratory

EN 61121 Programme To Use

- DRY COTTON - COTTON OR
- IRON DRY COTTON - COTTON OR WHITES
- EASY-CARE TEXTILE - DELICATES OR SYNTHETIC

EN

The real duration of drying cycle depends by the starting humidity level of the laundry due to spin speed, type and amount of load, cleanliness of filters and ambient temperature.

OPERATION

1. Open the door and load the drum with laundry. Ensure that garments do not hinder closure of the door.
2. Gently close the door pushing it slowly until you hear the door 'click' shut.
3. Turn the Programme Selector dial to select the required drying programme (see Programme Guide).
4. Press the button. The dryer will start automatically and the indicator above the button will be continuously lit.
5. If the door is opened during the programme to check the laundry, it is necessary to press to recommence drying after the door has been closed.
6. When the cycle is nearing completion the machine will enter the cool down phase, the clothes will be tumbled in cool air allowing the load to cool down.
7. Following the completion of the cycle the drum will rotate intermittently to minimize creasing. This will continue until the machine is switched OFF or the door is opened.
8. When the programme is complete the END indicator will light.

Maximum Drying Weight

Cottons	Max.capacity declared
Synthetics or Delicates	Max. 4 kg

Drying Guide

The standard cycle COTTON DRY () is the most energy efficient and best suited for drying normal wet cotton laundry.

The table in last page shows the approximate time and energy consumption of the main drying programmes.





Capacity (as energy label)	6 kg	7 kg	8 kg	9 kg / 10 kg
Power consumption of off-mode	0,40 W	0,40 W	0,40 W	0,40 W
Power consumption of on-mode	0,75 W	0,75 W	0,75 W	0,75 W

Technical Specifications

Drum capacity	115
Maximum load	See energy label
Height	85 cm
Width	60 cm
Depth	60 cm
Energy class	See energy label

Do not open the door during the automatic programs in order to obtain a proper drying.

8. SELECTING THE PROGRAMME AND SET THE FUNCTION

PROGRAM	PROGRAM DESCRIPTION	CAPACITY (kg)	DRYING TIME (min)
SMALL Load	Dedicated to get an even drying for extremely small loads.	2	*
XXL Load	Specific cycle dedicated to dry large linens e.g. curtains sheets and tableclothes. Thanks to a specific movement of the drum the linens will be dry minimizing tangles and folds.	6	*
 Cotton	Program Eco normative (hang dry) drying. The most efficient program in energy consumption. Suitable for cottons and linens.	Full	*
Whites	The right cycle to dry cottons, sponges and towels.	Full	*
Mix &  Dry	To dry all together different kind of fabrics as cotton, linen, mix, synthetics.	4	*
Darks & Coloured	A delicate and specific cycle to dry dark or coloured cotton or synthetics garments.	4	*
Shirts	This specific cycle has been conceived to dry shirts minimizing tangles and folds thanks to specific movements of the drum. It's recommended to take out the linens immediately after drying cycle.	2.5	*
Synthetics	To dry delicate and synthetic fabrics that need an accurate and specific treatment.	4	*
Jeans	Dedicated to dry uniformly fabrics like jeans or denim. It's recommended to flip over the garments before drying.	4	*
Rapid 45 Min.	Perfect to dry quickly up to 2 kg load. It's recommended to spin at high speed before drying.	1	*
 Wool	Woolen clothes: the program can be used to dry up to 1 kg of laundry (around 3 jumpers). It is recommended to reverse all clothes before drying. Timing can change due to dimensions and thickness of load and to spinning chosen during washing. At the end of the cycle, clothes are ready to be worn, but if they are heavier, edges can be a bit wet: it is suggested to dry them naturally. It is recommended to unload clothes at the very end of the cycle. Attention: felting process of wool is irreversible; please dry exclusively clothes with symbol (symbol "ok tumble"); this program is not indicated for acrylic clothes.	1	70'
Antiallergy	One specific cycle that dries and in the same time helps to reduce the main allergens as dust mites, pet hair, pollens and residual of powder detergents.	4	Max 220'
Pre Iron	This is a warm cycle that in only 12 minutes helps to relax folds and creases.	2.5	12'
Anti Odours	The perfect cycle to remove the smells from the linens smoothing creases.	2.5	20'
 One Touch	Customizable setting that interacts with the App on your android smartphone and to download the cycles (see the dedicated section). The factory sets the default programme Auto-Hygiene, which will sanitize the machine.		

*The real duration of drying cycle depends by the starting humidity level of the laundry due to spin speed, type and amount of load, cleanliness of filters and ambient temperature.

ONE TOUCH

This appliance is equipped with One Touch technology that allows you to interact, via the App, with smartphones based on Android operating system and equipped with NFC (Near Field Communication) function.

- Download on your smartphone the Hoover Wizard App.

The Hoover Wizard App is available for devices running both Android and iOS, both for tablets and for smartphones. However, you can interact with the machine and take advantage of the potential offered by One Touch only with Android smartphones equipped with NFC technology, according to following functional scheme:

Android smartphone with NFC technology	Interaction with the machine + contents
Android smartphone without NFC technology	Contents only
Android Tablet	Contents only
Apple iPhone	Contents only
Apple iPad	Contents only

FUNCTIONS

The main functions available using the App are:

- **Voice Coach** – A guide to help you choose the ideal cycle with only three voice inputs (clothes/fabrics, colour, drying level).
- **Programmes** – To download and launch new drying programmes.

- **Clever Care** – Clever Check-up and Auto- Hygiene cycles and a troubleshooting guide.

- **Reports** – Drying statistics and tips for a more efficient use of your machine.

Get all the details of the One Touch functions, browsing the App in DEMO mode or go to:
www.hooveronetouch.com

HOW TO USE SMART TOUCH

FIRST TIME - Machine registration

Enter the "**Settings**" menu of your Android smartphone and activate the NFC function inside the "**Wireless & Networks**" menu.

Depending on the smartphone model and its Android OS version, the process of the NFC activation may be different. Refer to the smartphone manual for more details.

- Turn the knob to the **One Touch** position to enable the sensor on the dashboard.

- Open the App, create the user profile and register the appliance following the instructions on the phone display or the "**Quick Guide**" attached on the machine.

More information, F.A.Q. and the video for an easy registration are available on:
www.hooveronetouch.com/how-to

NEXT TIME – Regular usage

- Every time you want to manage the machine through the App, first you have to enable the **One Touch** mode by turning the knob to the **One Touch** indicator.
- Make sure you have unlocked your phone (from stand-by mode) and you have activated the NFC function; then, follow the steps mentioned earlier.
- If you want to start a dry cycle, load the laundry and close the door.
- Select the desired function in the App (e.g.: starting a programme, the Clever Check-up cycle, update statistics, etc...).
- Follow the instructions on the phone display, **KEEPING IT ON** the **One Touch** logo on the machine dashboard, when requested to do so by the App.

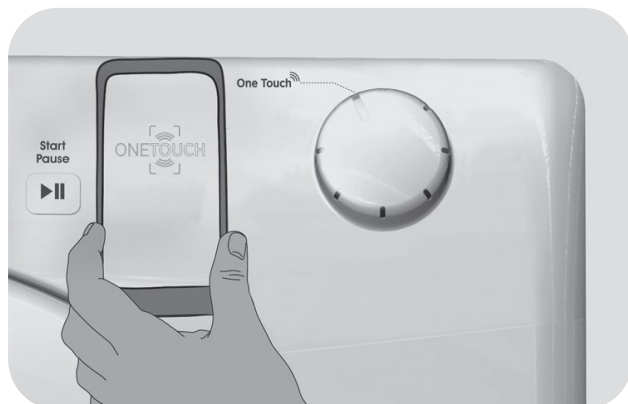

NOTES:

Place your smartphone so that the NFC antenna on its back matches the position of the Smart Touch logo on the appliance (as illustrated below).



If you do not know the position of your NFC antenna, slightly move the smartphone in a circular motion over the One Touch logo until the App confirms the connection. In order for the data transfer to be successful, it is essential TO KEEP THE SMARTPHONE ON THE DASHBOARD DURING THE FEW SECONDS OF THE PROCEDURE; a message on the device will inform about the correct outcome of the operation and advise you when it is possible to move the smartphone away.

Thick cases or metallic stickers on your smartphone could affect or prevent the transmission of data between machine and telephone. If necessary, remove them.

The replacement of some components of the smartphone (e.g. back cover, battery, etc...) with non-original ones, could result in the NFC antenna removal, preventing the full use of the App.

The management and the control of the machine via App is only possible "by proximity": it is therefore not possible to perform remote operations (e.g.: from another room; outside of the house).

WIRELESS PARAMETERS

Parameter	Specifications
Wireless Standard	ISO/IEC 14443 Type A and NFC Forum Type 4
Frequency band	13,553-13,567 MHz (centre frequency 13,560 MHz)
Magnetic field limit	< 42dBuA/m (at 10 meters)

With this the Candy Hoover Group Srl, declares that this appliance marked with **CE** complies with the essential requirements of the Directive 2014/53/EU. To receive a copy of the declaration of conformity, please contact the manufacturer at: www.candy-group.com

9. TROUBLESHOOTING

FOR ONE TOUCH MODELS

The **Hoover Wizard app** has a Clever Check-up function that allows you to confirm the functionality and status of the product at any time. To use the **Hoover Wizard app** you will need an Android smartphone with NFC technology.

More info can be found on the App.

If the display of the machine is showing an error (by a code or blinking LEDs), you should turn on the App on your Android smartphone, with NFC on. Place your smart phone against the **One Touch** logo on the control panel. You should now be able to read the fault directory to solve the issue.

What Might be the Cause of...

Defects you can remedy yourself

Before calling service for technical advice please run through the following checklist. A charge will be made if the machine is found to be working or has been installed incorrectly or used incorrectly. If the problem persists after completing the recommended checks, please call Service, they may be able to assist you over the telephone.

Time display to end could change during drying cycle. The time to end is continuously checked during the drying cycle and the time is adjusted to give the best estimation time. The displayed time may increase or decrease during the cycle and this is normal.

Drying time is too long/clothes are not dry enough...

- Have you selected the correct drying time/programme?
- Were the clothes too wet? Were the clothes thoroughly wrung or spindried?
- Does the filter need cleaning?
- Is the dryer overloaded?

The dryer does not operate...

- Is there a working electricity supply to the dryer? Check using another appliance such as a table lamp.
- Is the plug properly connected to the mains supply?
- Is there a power failure?
- Has the fuse blown?
- Is the door fully closed?
- Is the dryer switched on, both at the mains supply and at the machine?
- Has the drying time or the programme been selected?
- Has the machine been switched on again after opening the door?

The dryer is noisy...

- Switch off the dryer and contact GIAS Service for advice.

The Indicator is on...

- Does the filter need cleaning?

The Indicator is on...

- Does the water container need emptying?

CUSTOMER SERVICE

Should there still be a problem with your dryer after completing all the recommended checks, please call service for advice.

They may be able to assist you over the telephone or arrange for a suitable appointment for an engineer to call under the terms of your guarantee. However, a charge may be made if any of the following applies to your machine:

- Is found to be in working order.
- Has not been installed in accordance with the installation instructions.
- Has been used incorrectly.

Spares

Always use genuine spares, available direct from service.

Service

For service and repairs call your local service engineer.

The manufacturer declines all responsibility in the event of any printing mistakes in this booklet. The manufacturer also reserves the right to make appropriate modifications to its products without changing the essential characteristics.

Energy



Capacity



Time



	Capacity (kg)		6	7	8	9	10
	Class		B	B	B	B	B
☀ Whites	Energy	kWh	4,44	5,04	5,64	6,24	6,80
	Time	Min.	170	191	214	225	230
☀ Whites	Energy	kWh	4,18	4,75	5,31	5,88	6,44
	Time	Min.	148	166	185	205	210
☐ Cotton	Energy	kWh	3,70	4,20	4,70	5,20	5,70
	Time	Min.	126	141	157	176	195
☐ Cotton ½	Energy	kWh	2,05	2,31	2,56	2,80	3,00
	Time	Min.	77	84	91	100	108
☀ Whites	Energy	kWh	2,96	3,36	3,76	4,16	4,56
	Time	Min.	104	116	129	144	159



40013002