



GENERATION FUTURE

CleanJet 



INSTRUCTION MANUAL

IMPORTANT SAFETY REMINDERS

This cleaner should only be used for domestic cleaning, as described in this user guide. Please ensure that this guide is fully understood before operating the appliance. Use only attachments recommended or supplied by Hoover.

Only use attachments recommended or supplied by Hoover.

When using cleaning tools, ensure that the cleaner is kept in the upright (parked) position. This will avoid possible damage to the carpet or floor covering. When cleaning stairs, DO NOT position the cleaner above you.

IMPORTANT: The wires in the mains power lead are coloured in accordance with the following code: **Blue – Neutral** **Brown – Live**

STATIC ELECTRICITY. Some carpets can cause a small build up of static electricity. Any static discharge is not hazardous to health.

AFTER USE. Switch the cleaner off and remove the plug from the electricity supply. Always switch off and remove the plug before cleaning the appliance or attempting any maintenance task.

HOOVER SERVICE. To ensure the continued safe and efficient operation of this appliance we recommend that any servicing or repairs are only carried out by an authorised Hoover service engineer.

IMPORTANT: This cleaner is fitted with a brushbar. Care should be taken when cleaning stairs. Always ensure the BACK of the unit is placed at the base of the stairs to avoid the unit leaning forward causing possible damage to carpets.

This appliance can be used by persons (including children) with reduced physical, sensory or mental capabilities or lack of experience and knowledge if they have been given supervision or instruction concerning use of the appliance in a safe way and understand the hazards involved. Children shall not play with the appliance. Cleaning and user maintenance shall not be made by children.

IT IS IMPORTANT THAT YOU:

- Use indoors only.
- Use only on surfaces moistened by the cleaning process or small spills. Do not immerse product.
- Always install float before any wet pick up operation.
- Close supervision is necessary when any appliance is used by or near children. Do not allow cleaner to be used as a toy or to run unattended at any time.
- Keep hair, loose clothing, fingers, feet and all parts of body away from openings and moving parts.
- Do not pick up anything that is burning or smoking, such as cigarettes, matches, or hot ashes.
- DO NOT use aerosol sprays near cleaner. Aerosol sprays may be flammable.
- Do not pick up or use flammable or combustible materials such as gasoline or fine wood sandings or use in areas where they may be present.
- Avoid picking up hard, sharp objects with the cleaner. They may damage the machine.
- Do not put any object into openings. Do not use with any opening blocked; keep free of dust, lint, hair, and anything that may reduce air flow.
- Do not pull or carry by cord, use cord as a handle, close door on cord or pull cord around sharp edges or corners. Do not run appliance over cord. Keep cord away from heated surfaces.
- Always disconnect cord from electrical outlet before servicing the cleaner.
- Unplug cleaner when not in use. Turn off all controls before unplugging.
- Do not unplug by pulling on cord. To unplug, grasp the plug, not the cord.
- Never handle plug or appliance with wet hands.
- Do not clean over floor electrical outlets.
- Do not use without tanks in place.
- Use extra care when cleaning on stairs. Do not place cleaner on stairs.
- Keep detergents and other cleaners out of children's reach.
- Do not pick up chlorine bleach, drain cleaner, gasoline or any other toxic material with this appliance.
- When using recommended chemicals with this machine, be certain area is well ventilated.
- Do not use a flammable or combustible liquid to clean a floor.
- Follow manufacturer's instructions for all chemicals used with this machine. Do not exceed recommended mixing ratios.
- Store in a dry place. Do not expose machine to freezing temperatures.
- Do not continue to use your cleaner if it appears to be faulty. If the power cord is damaged stop using the cleaner IMMEDIATELY. To avoid a safety hazard, an authorised Hoover service engineer must replace the power cord.
- Use cleaner only for its intended use as described in the instructions.

GETTING TO KNOW YOUR CLEANER

CLEANJET

Congratulations on the purchase of your new Hoover Cleanjet Carpet Shampooer.

Please take the time to read this manual carefully.

You'll then be ready to make the most of the special features only the new Hoover Cleanjet can offer!

When first unpacking your cleaner please check all items are included:

Cleaner body
Cloth adaptor plate*
Cloth*

In the unlikely event that any item is missing or you experience any problems with the product

Please contact the Hoover customer helpline:
Tel.: AUS: 1300 360 845 NZ: (09) 263 7573
Email: sales@hooverfloorcare.com.au

Should any faults occur with your cleaner during the first 12 months, contact the Hoover Customer Helpline on the number above.

If you are having difficulty in obtaining filters or any other accessories for your cleaner, contact the Hoover Customer helpline or order online at

www.hoover.com.au

www.hoover.co.nz

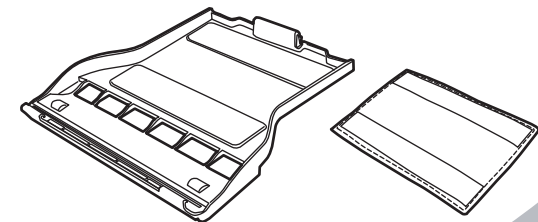
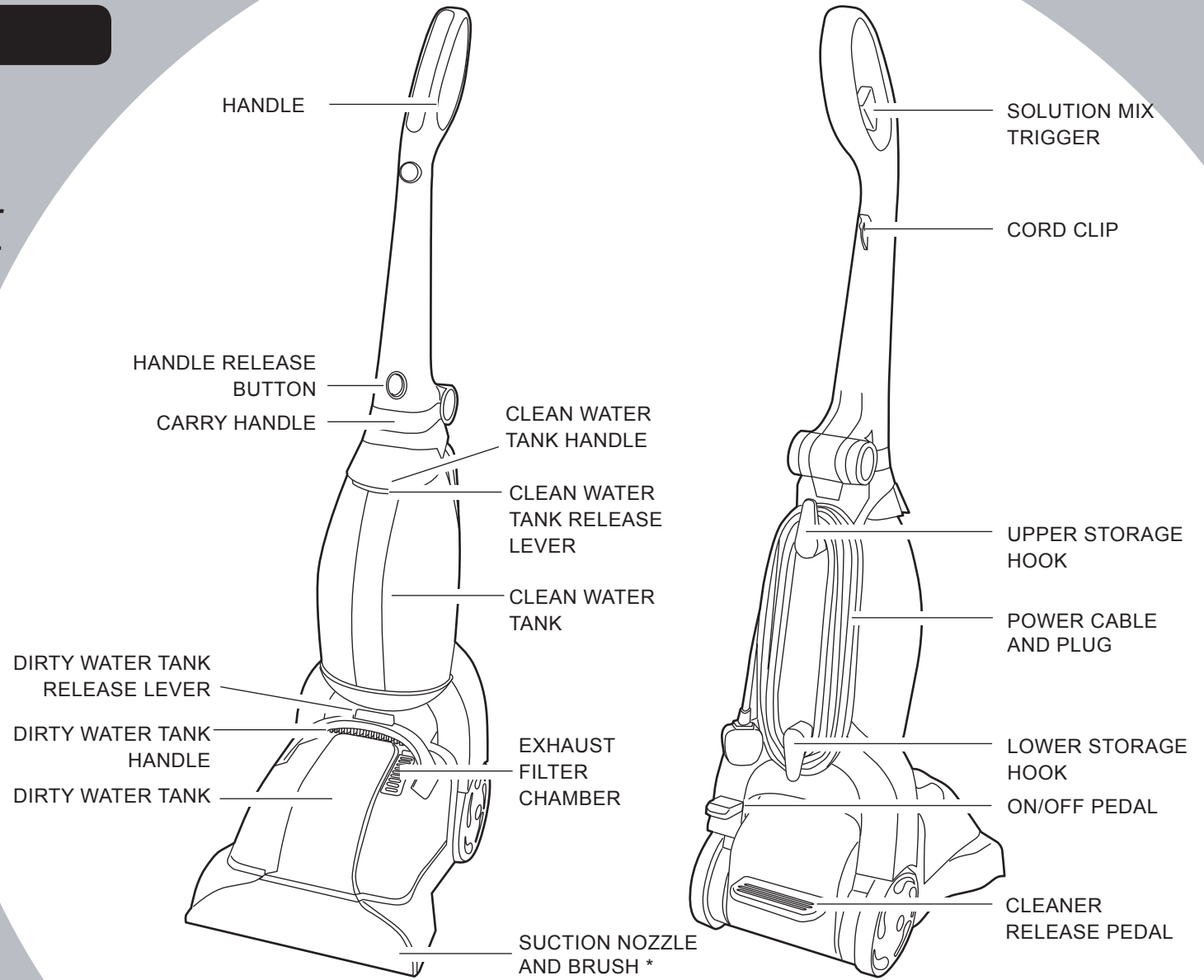

(*Certain models only)

PREPARING YOUR CLEANER

- 1 This appliance should be switched off and disconnected from the power supply before preparing the cleaner.

- 2 Remove the accessories from the main packaging. You should find the following:

Cleaner body
Cloth adaptor plate*
Cloth*

- 4 To fold the handle press the handle release button and fold to the storage position.

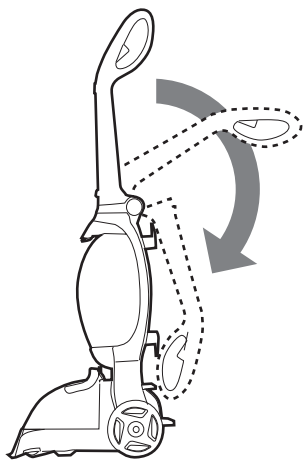

- 3 Raise the handle to the upright position until it locks in place.

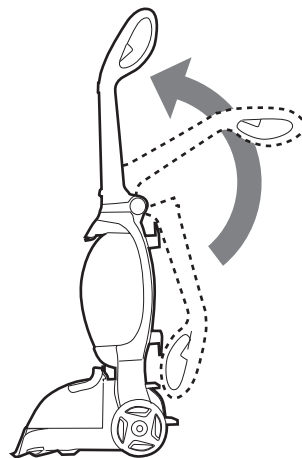

- 5 Once the handle has been lowered lift the carry handle to allow the cleaner to be carried from room to room.

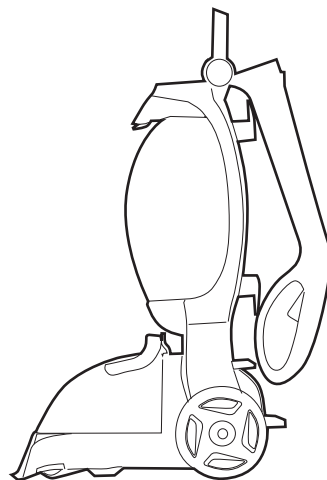

BEFORE CLEANING CARPET

- **Vacuum carpet thoroughly. Use a vacuum cleaner with a power head for best results.**
- **Test for colourfastness**
- **Move the furniture**

Test for colourfastness - Wet a white absorbent cloth with the solution. In a small, hidden area of your carpet, gently rub the surface with the dampened cloth.

Wait ten minutes and check for colour removal or bleed with a white paper towel.

If your carpet has more than one colour, check all colours.

When cleaning an entire room, move furniture out of the area to be cleaned. If the furniture is too heavy to move, place aluminium foil or wax paper under legs. This will prevent wood finishes from staining your carpet. Pin up furniture skirts and curtains.

NOTE: Do not over saturate your carpet.

! IMPORTANT: This cleaner should not be used to dry vacuum the carpet.

(*Certain models only)

FILLING THE CLEAN WATER TANK

The clean water tank holds the water and cleaning solution.

IMPORTANT: Always turn the cleaner off and disconnect from the electrical outlet before filling the clean water tank.



IMPORTANT: When filling the clean water tank, do not exceed the max fill line.

- 1 Add the required amount of cleaning fluid to a measuring jug. (approx. 40ml per 1L of water)

Do not use any high-foaming solutions as an excessive amount of foam impairs the functioning of the shampooer.



- 2 Mix the solution with warm water. (Max. temperature - 40°C)

Do not use boiling water. Preferably use distilled water to prevent calcification.



- 3 Press the clean water tank release latch and remove from the cleaner.

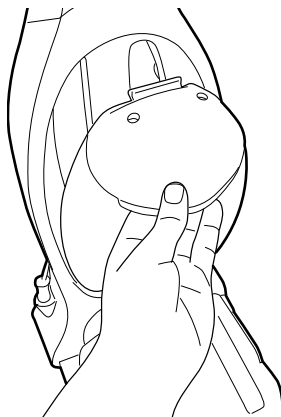

- 4 Open the screw cap on the bottom of the tank.

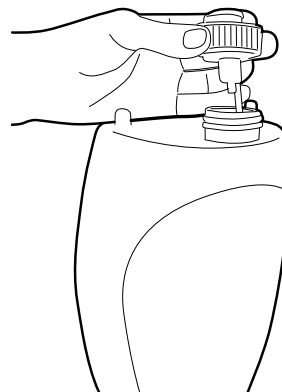

- 5 Pour the solution into the clean water tank. Do not exceed the max fill line. Replace the cap and return the clean water tank to the cleaner.

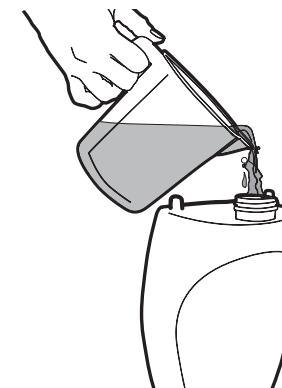

CLEANING CARPETS

Dry vacuum the carpet thoroughly before cleaning the carpet. Use a vacuum cleaner with a powerhead for best results.

Never operate without filters as damage to the appliance could occur.

Ensure the carpet has been checked for colour fastness.



IMPORTANT: This cleaner should not be used to dry vacuum the carpet.

- 3 Press the cleaner release pedal and recline the cleaner.

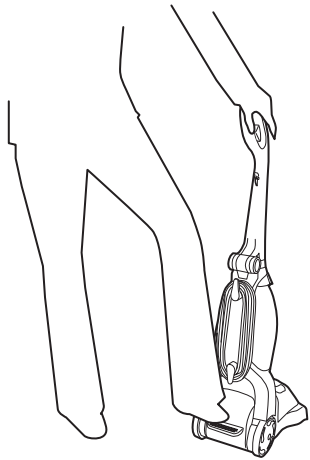

- 1 Unwrap the power cord and plug the cleaner into the power supply.

IMPORTANT: Never leave the appliance unattended with the power on. Turn off when emptying and filling tanks.

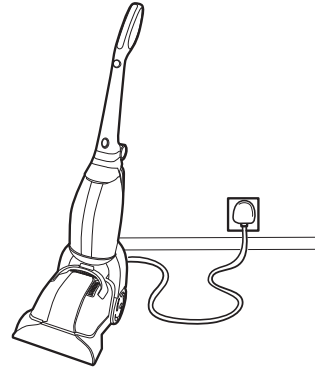

- 4 Press the solution mix trigger to release the solution.



- 2 Press the ON/OFF pedal.

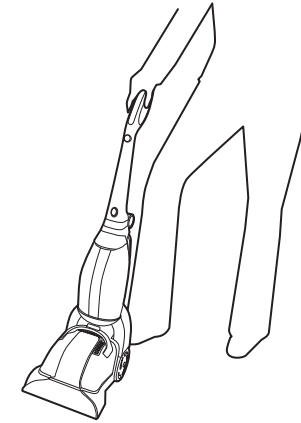

- 5 For best results apply the solution on the forward stroke (press trigger) and recover the solution on the backward stroke (release trigger).

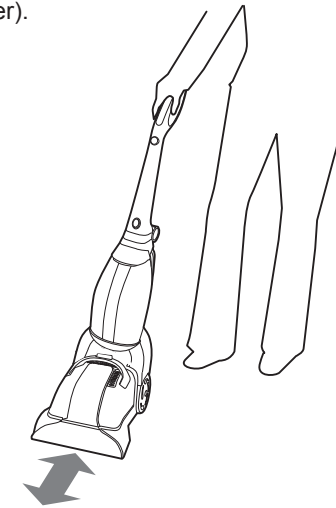

CLEANING HARD FLOORS*

- 1 Attach the Velcro side of the cloth to the underside of the cloth adaptor plate.

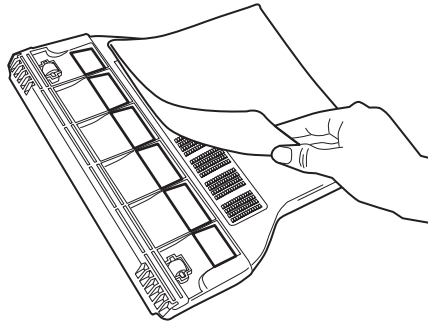

Attached the cloth adapter plate to the foot of the cleaner.

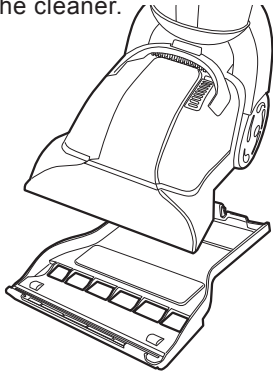

- 2 Use the cleaner as described in 'Cleaning Carpets'.
- 3 After use remove the cloth from the adapter plate and wash the cloth pad in a washing machine with a mild detergent at maximum temperature 30°C. Do not use a fabric softener.

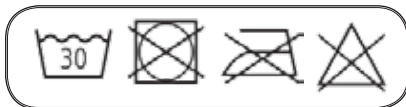

WARNING: Use only Hoover carpet cleaning solution. Using other solutions may affect your warranty.

* Certain models only

STORAGE

Before storing the cleaner:

Turn the cleaner off and disconnect from the electrical socket.

Empty and rinse the dirty water tank. Allow to air dry.

Press the handle release button and lower the handle for storage.

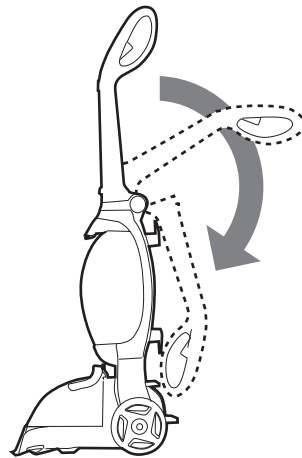

Do not store the cleaner on a wood surface unless the cleaner is completely dry.

Prior to storing the machine, empty out any remaining formula from the formula tank and rinse out the machine by running a tank of fresh water from the formula tank.

CORD STORAGE

Turn the cleaner off and remove the plug from the electrical socket. Wind the cord around the cord storage hooks.

Rotate the storage hooks to quickly release the full length of the power cord.

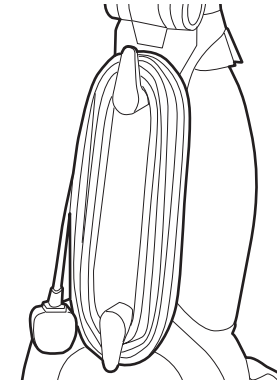

CORD CLIP

Do not run over the supply cord.

Clip the supply cord in the cord clip at the back of the handle to avoid accidentally running the cleaner over the cord and causing any damage



EMPTYING THE DIRTY WATER TANK

! **WARNING: DO NOT** exceed the max fill line on the dirty water tank.

- 1** Press the dirty water tank release lever.

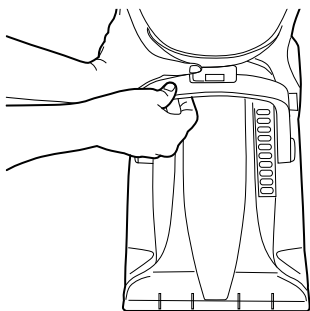

- 2** Remove the dirty water tank from the cleaner.

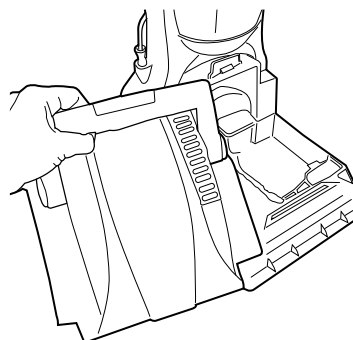

- 3** Turn the tank cap anti-clockwise to open.

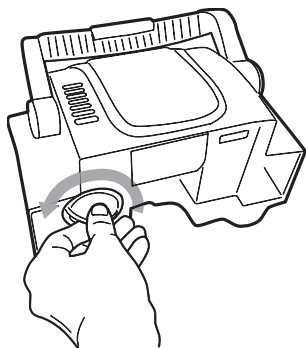

- 4** Empty the tank. Rinse the tank with clean water and allow to dry before storing the cleaner.

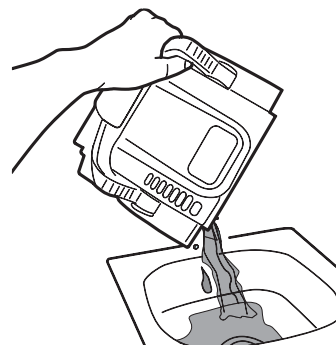

! **WARNING: Always switch the cleaner off and unplug it from the electrical sock before emptying the dirty water tank.**

CLEANING THE EXHAUST FILTER

Press the exhaust filter release latch.

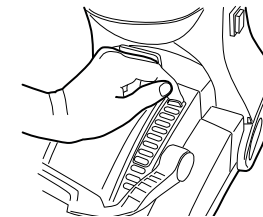

Remove the exhaust filter chamber.

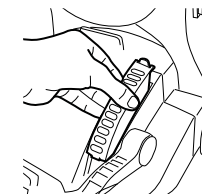

Remove the filter from the chamber. Rinse under hand warm water to remove any debris. Allow to completely dry before returning to the cleaner.

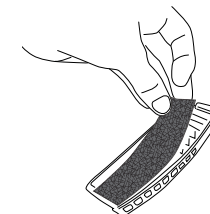

Do not wash filters in the washing machine.

CLEANING THE PRE MOTOR FILTER

The pre motor filter is located under the dirty water tank.

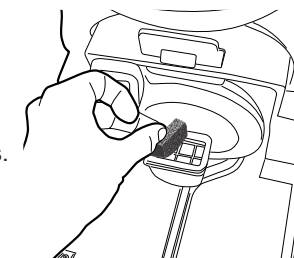

Rinse under hand warm water to remove any debris. Allow to completely dry before returning to the cleaner.

Do not wash filters in washing machine.

! **IMPORTANT: Clean the filters after each use.**

! **WARNING: Ensure both filters are fitted to the cleaner before use.**

CLEANING THE BRUSHBAR*

Turn the cleaner upside down. Remove any threads or debris from the brush bar.

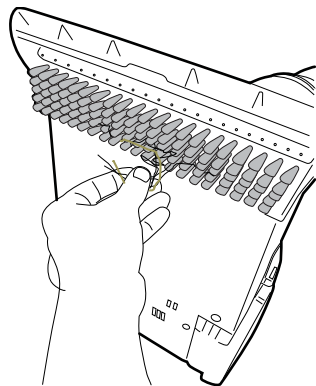

CLEANING THE AGITATOR*

Remove any threads or debris ensuring the agitator can rotate freely.

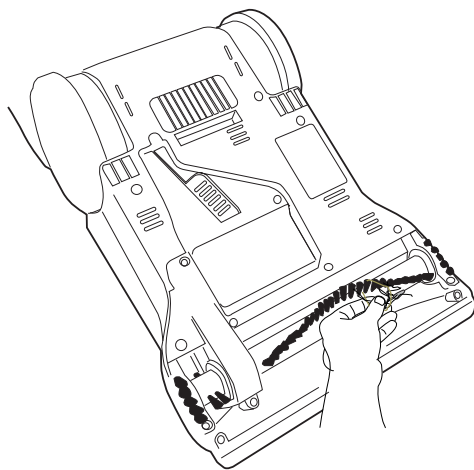

! THIS FEATURE VARIES ACCORDING TO MODEL

Please check your the underside of your cleaner and follow the appropriate instructions.

* Certain models only

CHANGING THE BRUSHBAR*

- 1 Press the dirty water tank release lever and remove the dirty water tank. Unscrew 4 retaining screws on the top surface.

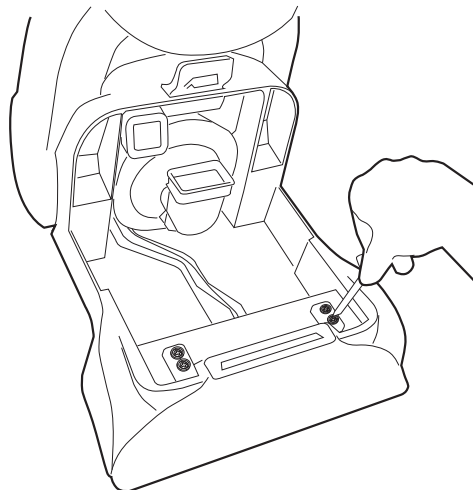

- 3 Unscrew 2 retaining screws located on the underside of the detergent nozzle. Remove the brushbar from the nozzle.

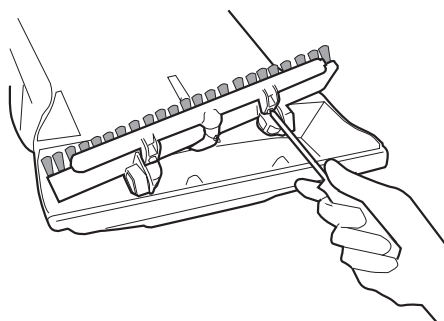

! THIS FEATURE VARIES ACCORDING TO MODEL
Please check your the underside of your cleaner and follow the appropriate instructions.

! **IMPORTANT:** Switch the cleaner off and remove the plug from the electricity supply before dismantling cleaner .

- 2 Turn the cleaner over. Remove the brushbar alignment brackets.

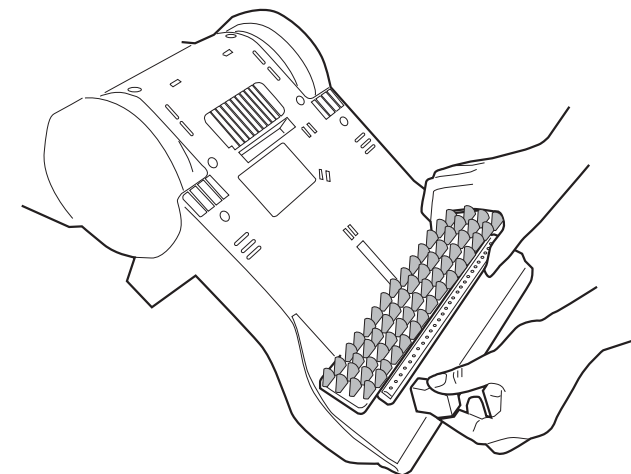

- 4 Replace the brush bar and attach to the nozzle. Attach the alignment brackets and assemble to the cleaner.

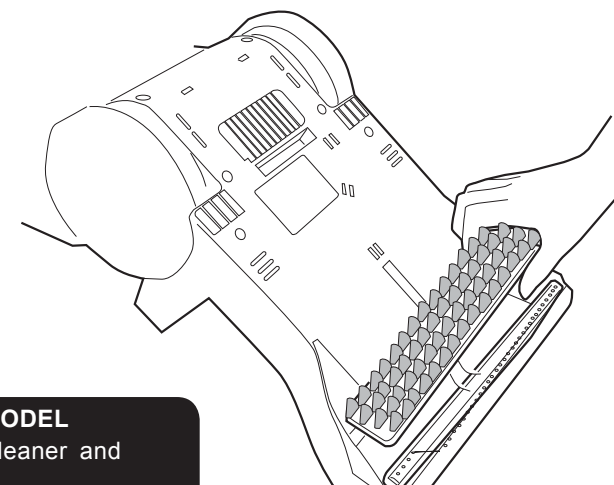

CHANGING THE AGITATOR / BELT*

- 1 Turn cleaner over and remove 7 retaining screws.

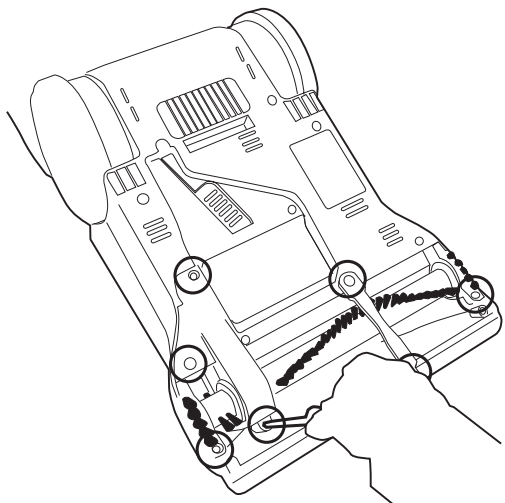

- 4 Remove the agitator brackets.

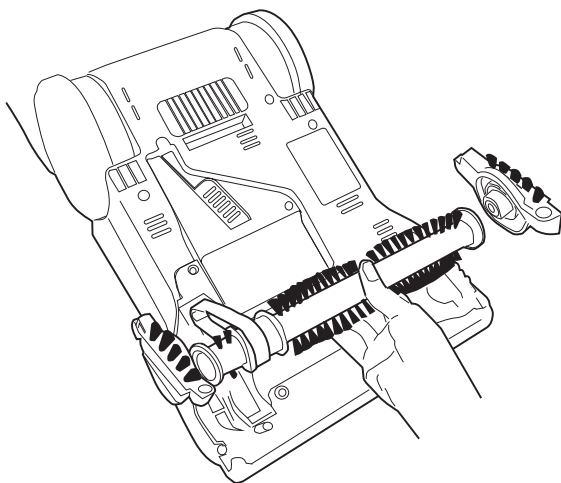

- 2 Remove the belt cover and safety bar.

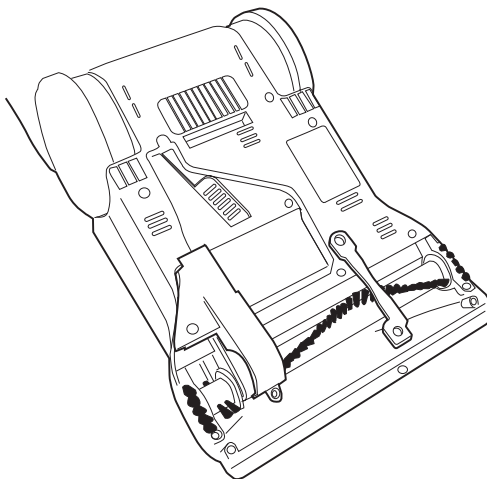

- 5 Replace the agitator by looping the belt around the agitator making sure it sits securely in the belt channel.

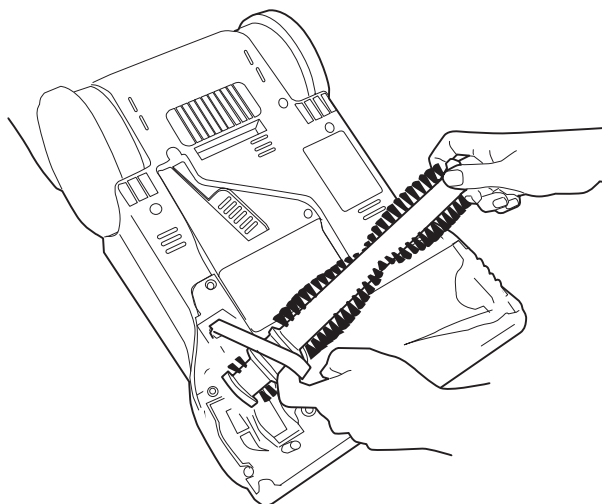

- 3 Slide the agitator assembly out of the cleaner and check the belt for wear.

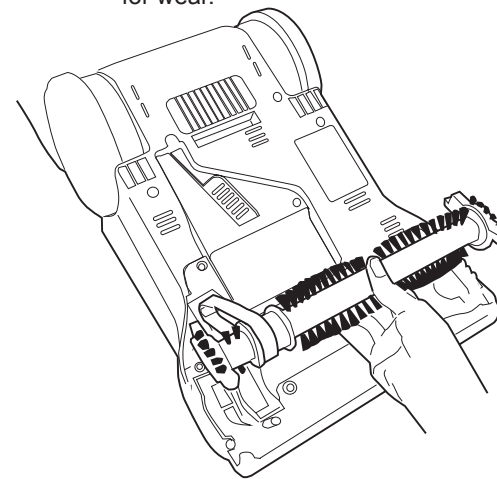

- 6 Re-assemble the agitator assembly to the cleaner ensuring the agitator can rotate freely.

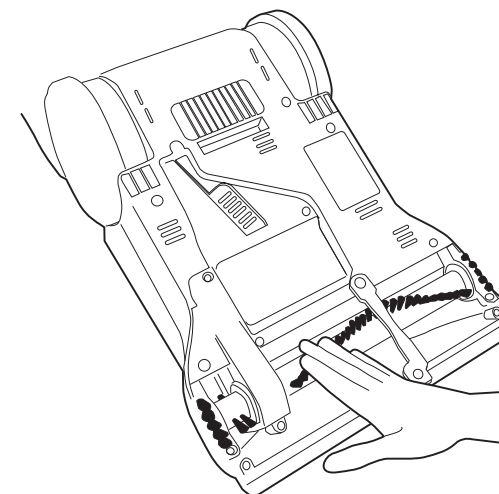

THIS FEATURE VARIES ACCORDING TO MODEL

Please check your the underside of your cleaner and follow the appropriate instructions.

* Certain models only

Troubleshooting

If your cleaner is not working properly run through the following checklist.

WARNING: To reduce the risk of personal injury, unplug the carpet washer before performing maintenance/troubleshooting checks.

Why won't the carpet washer turn on?

- It may not be plugged into the electrical outlet correctly: ensure that the plug is pushed in securely and switched on.
- The power button on the unit hasn't been fully depressed.
- If unit cuts out during use, disconnect the unit from the wall socket, allow to cool for one hour, clean the filter and empty the dirty water tank and check hose, brushbar for blockages.

Why won't the cleaner pick up solution/spills?

- The dirty water tank may be full and the auto shut off engaged. Empty the dirty water tank.
- Ensure the dirty water tank is fitted correctly and the tank cap is securely fitted.
- Check the brushbar for blockages.

Why won't the solution/clean water dispense?

- Ensure the clean water tank is fitted securely.
- The solution/clean water tank may be empty.
- Ensure dirty water tank is fitted securely.

If there is any doubt call the **Hoover Customer Helpline** for advice. They may be able to assist you over the telephone.

Genuine HOOVER Spares

Tel. : AUS: 1300 360 845 NZ: (09) 263 7573
www.hoover.com.au www.hoover.co.nz

Always replace parts with genuine Hoover spares. When ordering parts, always quote your model number.

Hoover Customer Helpline

Should any faults occur with your cleaner during the first 12 months, contact the Hoover Customer Helpline on the number below.

Tel.: AUS: 1300 360 845 NZ: (09) 263 7573
Email: sales@hooverfloorcare.com.au

Quality

BSI ISO 9001

Hoover's factories have been independently assessed for quality. Our products are made using a quality system which meets the requirements of ISO 9001.

Environment - WEEE Directive



This appliance is marked according to the European Directive 2011/65/EC on Waste Electrical and Electronic Equipment (WEEE).

By ensuring this product is disposed of correctly you will help prevent potential negative consequences for the environment and human health, which could otherwise be caused by inappropriate waste handling of this product.

The symbol on the product indicates that this product may not be treated as household waste. Instead it shall be handed over to the appliance collection point for recycling of electrical and electronic equipment.

Disposal must be carried out in accordance with the local environmental regulations for waste disposal.





For more detailed information about treatment, recovery and recycling of this product, please contact your local city office, your household waste disposal service or the shop where you purchased the product.

GUARANTEE STATEMENT

The guarantee conditions for this appliance are as defined by our representative in the country in which it is sold. Details regarding these conditions can be obtained from the dealer from whom the appliance was purchased. The bill of sale or receipt must be produced when making any claim under the terms of this guarantee.

Subject to change without notice.

Technical Specification

Model	CJ600	CJ800
	240V 600W	240V 800W
	5.5	6.8
	2.5	2.5
	335	335
	955	955
	340	340



1 Year GUARANTEE

This guarantee applies in Australia and New Zealand only.
For the guarantee in another country, please
contact your local retailer/distributor.

Your Hoover cleaner, in the case of domestic use, has a two year parts and labour warranty against product defects and failures when the product is used in accordance with the terms and conditions of this warranty statement.

This warranty commences from the original date of purchase and is not transferable; please retain your original proof of purchase for any warranty claims. This warranty is valid only in the country where the cleaner is purchased.

The cleaner must be operated in accordance with these instructions and used only for domestic household cleaning to remove DRY dirt and dust from household carpets, flooring and fabrics. This cleaner is not fit to be used as an industrial cleaner, and is not designed for the collection of vitreous building material including particle board, construction products and similar products such as wood/fibres, cement, fillers, fibre glass etc or excessive or frequent sand. The infrequent pick-up of these materials in these circumstances may be harmful to your cleaner and may void the manufacturer's warranty.

Accessories and consumables including dust bags and filters, unless defective in manufacture, are not subject to this warranty. In order to prolong the life of accessories and consumables, regular care and maintenance is recommended.

When properly used and cared for, your cleaner will render excellent service; refer to the instruction manual for further details, as misuse or failure to follow the instruction makes this warranty void.

In the event of service or advice being needed, please contact Hoover Floorcare Asia Pacific Pty Ltd, Level 1, Building 2 Brandon Business Park, 530 Springvale Road Glen Waverley Victoria 3150,

or on 1300 360 845, Monday- Friday 9am - 5pm EST. The decision to repair or replace the cleaner is at the discretion of Hoover Floorcare. If Hoover Floorcare decide to repair or replace the cleaner, it will do so at its own cost.

Hoover Floorcare is unable to accept responsibility under this warranty for any repair work not carried out by an authorised Hoover Service Agent or from the use of non-genuine parts. If any part is no longer available or manufactured, Hoover Floorcare will replace it with a genuine functional replacement part. This warranty does not apply to the cost of replacing any parts of the product due to normal wear and tear, alterations, improper installation, physical abuse, misuse or accidental damage. Any transportation costs involved in the repair of defective parts shall be borne by the claimant.

If proof of purchase cannot be provided at the time of a warranty claim or service, any work carried out on the cleaner is chargeable.

The repair or replacement of the cleaner under this warranty does not extend the original period of warranty.

The benefits conferred by this warranty are in addition to all other rights and remedies in respect of the product as outlined under the Competition and Consumer Act and other State and Territory laws.

"Our goods come with guarantees that cannot be excluded in the Australian Consumer Law. You are entitled to a replacement or refund for a major failure and for compensation for any other reasonably foreseeable loss or damage. You are also entitled to have the goods repaired or replaced if the goods fail to be of acceptable quality and the failure does not amount to a major failure."

GENERATION FUTURE

Keep this Guarantee with your receipt as proof of purchase should you ever require service.

Purchase Date...../...../.....

Hoover Floorcare policy is one of continuous development and accordingly we reserve the right to change specifications without prior knowledge.
Contents are copyright.

HOOVER FLOORCARE ASIA PACIFIC PTY LTD. (ABN 37 086 345 575)
Level 1, Building 2 Brandon Business Park, 530 Springvale Road Glen Waverley Victoria 3150



GENERATION FUTURE

Hoover Floorcare Asia Pacific Pty Ltd
(ACN 086 345 575)
Level 1, Building 2, Brandon Business Park
530 Springvale Road, Glen Waverley
Victoria 3150

Due to a policy of continuous improvement
some specifications may change prior to
notification.

The words HOOVER and the circular
emblem are registered trademarks.

Hoover Customer Helpline
1300 360 845
NZ: (09) 263 7573
www.hoover.com.au
www.hoover.co.nz

**Made in China to our exact
specifications**

**Designed and Engineering
in Italy**

PRINTED IN CHINA.
48007958
V1 05/13